



RELIABLE POWER FOR  
A SUSTAINABLE WORLD  
**GENERAL CATALOGUE**





**Reliable power for a sustainable world**

# Contents

|            |          |
|------------|----------|
| <b>Key</b> | <b>4</b> |
|------------|----------|

## **Company**

|                           |           |
|---------------------------|-----------|
| Riello UPS                | <b>6</b>  |
| Riello UPS Brand values   | <b>8</b>  |
| Energy and sustainability | <b>9</b>  |
| Riello UPS and Ducati     | <b>12</b> |

## **Quick references**

|   |           |
|---|-----------|
| Options and accessories compatibility table |           |
| UPS CE/IEC Standard                         | <b>14</b> |

|                         |           |
|-------------------------|-----------|
| <b>Application Area</b> | <b>16</b> |
|-------------------------|-----------|

## **UPS**

|                   |           |
|-------------------|-----------|
| iPlug             | <b>24</b> |
| iDialog           | <b>28</b> |
| iDialog Rack      | <b>30</b> |
| Net Power         | <b>32</b> |
| Vision            | <b>34</b> |
| Vision Rack       | <b>38</b> |
| Vision Dual       | <b>42</b> |
| Sentinel Rack     | <b>46</b> |
| Sentinel Pro      | <b>50</b> |
| Sentinel Dual SDH | <b>54</b> |
| Sentinel Dual SDU | <b>58</b> |
| Sentinel Tower    | <b>64</b> |
| Sentryum          | <b>68</b> |

|                       |            |
|-----------------------|------------|
| Multi Sentry          | <b>80</b>  |
| NextEnergy            | <b>86</b>  |
| Master MPS            | <b>98</b>  |
| Master HP & Master HE | <b>106</b> |
| Master Industrial     | <b>114</b> |
| Master FC400          | <b>116</b> |
| Multi Power           | <b>118</b> |
| Multi Power2          | <b>128</b> |
| Sentryum Rack         | <b>136</b> |
| Sentryum Rack Marine  | <b>140</b> |

## **UPS for North America (UL/CSA standards)**

|                             |            |
|-----------------------------|------------|
| Products portfolio overview | <b>146</b> |
|-----------------------------|------------|

## **CPS**

|                            |            |
|----------------------------|------------|
| Central Supply Systems CSS | <b>152</b> |
|----------------------------|------------|



## **Transfer Systems**

|                                |            |
|--------------------------------|------------|
| Multi Pass 10, 16 and 16-R     | <b>160</b> |
| MBB 125 A 4P, MBB 100 A 2P     | <b>160</b> |
| Multi Socket PDU               | <b>162</b> |
| Multi Switch                   | <b>164</b> |
| Multi Switch ATS               | <b>168</b> |
| Master Switch STS Single-phase | <b>172</b> |
| Master Switch STS Three-phase  | <b>174</b> |

## **Special Solutions**

|                           |            |
|---------------------------|------------|
| SuperCaps UPS             | <b>180</b> |
| Lithium Battery Solutions | <b>184</b> |







## **Software and Connectivity**

|                          |            |
|--------------------------|------------|
| PowerShield <sup>3</sup> | <b>188</b> |
| PowerNetGuard            | <b>189</b> |
| NetMan 208               | <b>190</b> |
| MultiCom 302             | <b>191</b> |
| MultiCom 352             | <b>191</b> |
| MultiCom 372             | <b>191</b> |
| MultiCom 384             | <b>191</b> |
| MultiCom 392             | <b>192</b> |
| MultiCom 411             | <b>192</b> |
| MultiCom 421             | <b>192</b> |
| Multi I/O                | <b>192</b> |
| Multi Panel              | <b>193</b> |
| Connectivity             | <b>194</b> |

## **Services and contacts**

|                       |            |
|-----------------------|------------|
| Pre-sales Consultancy | <b>200</b> |
| Technical Assistance  | <b>202</b> |
| RielloConnect         | <b>204</b> |
| Operating Offices     | <b>208</b> |

# Key

|              |   |  |  |
|--------------|---|--|--|
| <b>1:1</b>   | Single-phase input and output                             |    | UPS VFD<br>(Voltage Frequency Dependent)       |
| <b>1:3</b>   | Single-phase input,<br>three-phase output                 |    | UPS LINE INTERACTIVE<br>(Voltage Independent)  |
| <b>3:1</b>   | Three-phase input,<br>single-phase output                 |    | UPS ON LINE<br>(Voltage Frequency Independent) |
| <b>3:3</b>   | Three-phase input and output                              |   | Tower  |
| <b>1-3:1</b> | Single-phase or three-phase<br>input, single-phase output |  | Rack   |
| <b>1-3:3</b> | Single-phase or three-phase<br>input, three-phase output  |  | Rack / Tower                                   |
|              |   |  | Modular system                                 |





UPS suitable for Digital Living applications



UPS suitable for Data Center applications



UPS suitable for electro-medical applications



UPS suitable for industrial applications



UPS suitable for transport applications (railways, airports, naval)



UPS suitable for emergency applications



UPS with "UL listed" certificate for North America



UPS with "TUV Rheinland" certificate for North America



UPS with GS Nemko certificate



UPS ready for use in Smart Grids



Battery Swap. The batteries can be replaced during operation



Lithium battery compatible



UPS also available with supercaps instead of batteries



EnergyShare sockets can be configured to disconnect load at user defined time (load shedding)



Plug & Play. The UPS can be installed without the need for qualified personnel



Installation and initial start up should be carried out by qualified personnel



The device has a USB port



Riello Elettronica, an Italian enterprise led by Pierantonio Riello, is the holding company of a group of businesses operating in the industrial world across three divisions: energy, automation and security. As world recognised brand in power continuity, world leader in the market of static UPS and excellence of the 'Made in Italy', Riello UPS designs and manufactures intelligent electronic equipment that acts as an energy reserve in the event of a grid blackout or disruption.

Riello UPS offers a complete range of single-phase and three-phase UPS from 400 VA to 6.4 MVA and provides advanced UPS systems both modular and monolithic, transformer-free or transformer-based, for any type of power applications for Data Centers, offices, healthcare, emergency, safety and security facilities, industrial complexes and telecommunication systems.

In addition, Riello UPS often provides tailored solutions in the event of large tenders or commissions. These solutions are based on the specifications provided, demonstrating the company's attention to customer needs.

Riello UPS operates two research centers of excellence, in Legnago (Verona) and Cormano (Milan), dedicated to the development, design and testing of UPSs.

This allows us to continuously innovate our product portfolio, maintaining the highest levels of performance, reliability and competitiveness.

In fact, Riello UPS has always maximised product performance and constantly evolves its offer, which today incorporates **24 product lines** for energy management based on multiple technological architectures.







- Subsidiaries
- Distributors
- 7 Riello UPS companies
- Rep. Offices

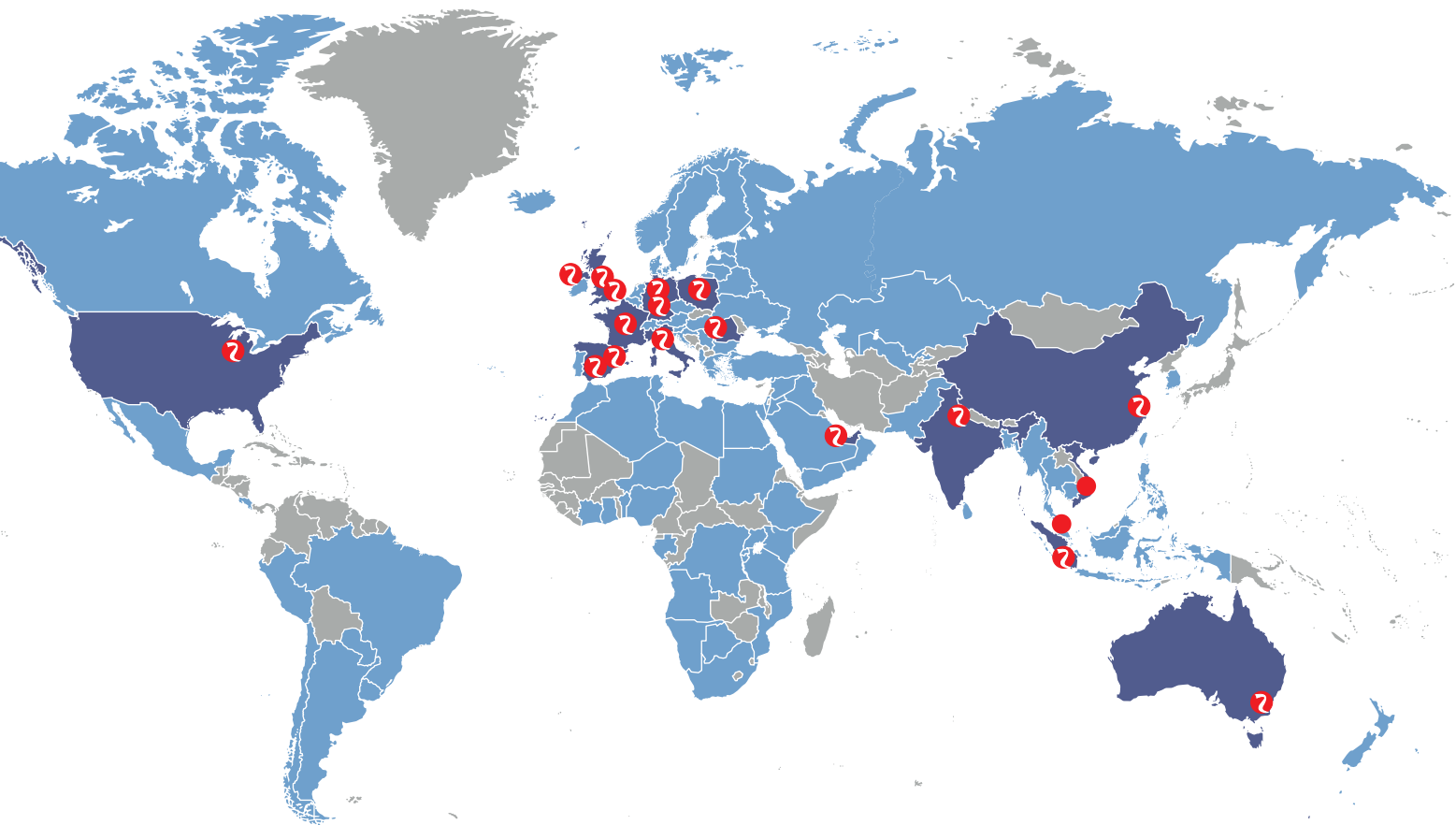

## GLOBAL PLAYER

Riello UPS is a leader in Italy and is firmly placed among the top 5 global companies in the field of power continuity. With 17 dedicated branches and a network of distributors giving us a presence in more than 85 countries, we deliver outstanding services to local customers. Our global reach spreads across Europe, the United States, the United Arab Emirates, China, India, Singapore, Vietnam and Australia.

**1000**  
EMPLOYEES

**85**  
BUSINESS COUNTRIES

**17**  
COMPANIES

**3**  
PRODUCTION SITES



# Riello UPS

## Brand Values

### INNOVATION

#### the secret of an all-Italian success story

Riello UPS offers a diverse choice of products organised into 24 ranges of uninterruptible power supplies (UPS) incorporating several different state-of-the-art technological architectures.

Thanks to its two research centers in Legnago (Verona) and Cormano (Milan), world class centers of excellence for the design, development and testing of uninterruptible power supplies, Riello UPS constantly innovates its product portfolio, keeping it at the pinnacle of performance, reliability and competition.

In addition, in the event of large tenders or

specialist commissions Riello UPS often provides bespoke solutions based on the specifications provided, demonstrating its attention to the customer's individual requirements.

Riello UPS designs and manufactures its UPS in Italy in order to maintain direct control over quality and reliability standards. Our structure also gives us complete control over the entire manufacturing, sales and after-sales service processes.

This customer-centric strategy encourages continuous improvement by monitoring

customer feedback and using it to make rapid adjustments to optimise features as required by the market. This process further consolidates Riello UPS's reputation as a reliable, dynamic and quality-oriented company. It doesn't stop here however: the successful development of innovative and modern UPS solutions such as Modular UPS and Smart Grid Ready UPS (i.e. compatible with intelligent power distribution grids which represent the future of energy supplies), are clear proof that innovation and quality are two of the secrets of Riello UPS's success.



# Reliable power for a sustainable world

## Energy and sustainability in one hand

**“Reliable power for a sustainable world” is the Riello UPS philosophy condensed into few simple words; a global brand constantly searching for the most innovative solutions that ensure a dual safety: a solid critical-load protection that also keeps the protection and sustainability of Planet Earth at the forefront of our minds.**

Riello UPS manufactures efficient solutions that ensure power quality and business continuity. The company constantly implements new ideas and technologies to increase the efficiency of its products and reduce their power consumption and environmental impact.

To this end, the company also invests

significantly in new technologies that exploit clean and renewable energy sources. Riello UPS’s social commitment aims to help the present as well as shape a bright, sustainable future, combining the inevitable need for energy with environmental protection:

- All the ON LINE Riello UPS product portfolio from 1 kVA upwards, is fully compliant with the Elite classification of the Code of Conduct (CoC) for the energy efficiency of UPS (2021-2023), published by CEMEP and agreed with the Joint Research Center of the European Commission. Compared to standard UPS, Riello UPS solutions are more efficient, with energy saving that allows a fast return on investment and a significant

**reduction in carbon dioxide emissions’ therefore helping the atmosphere.**

- Riello UPS pays close attention to the use of low environmental impact materials from the initial design development and testing stage through to the final release of its products into the market.
- Riello UPS employs an environmental management system that is ISO 14001 certified.
- Huge attention is given to the evolution of the electric grid, in particular to the use of renewable energy sources: the Riello UPS offer incorporates not only traditional and Smart Grid Ready UPS, but also photovoltaic inverters and Energy Storage Systems (ESS).

## RIELLO UPS SIGNS UP TO ENHANCED EFFICIENCY CODE OF CONDUCT 2021-2023

The entire range of Riello UPS products falls within the 'Elite' highest energy efficiency level.

Riello UPS solutions protect and supply any critical power application from data centers, complex industrial processes and telecommunication and IT systems, through to healthcare buildings, public administration data and digital living appliances in use today. Within these environments, energy management is critical and running costs must be minimised without compromising on resilience and availability.

Equipment and processes must operate at the highest possible levels of efficiency to reduce the strain on critical power supplies, whether public or private grids and minimise the environmental impact on the installation area.

Always sensitive to these energy efficiency issues and as an active member of CEMEP (the European Committee of Manufacturers of Electrical Machines and Power Electronics), Riello UPS was among the first signatories of the new edition of the "Code of Conduct for the Energy Efficiency of Uninterruptible Power Groups 2021-23" (CoC), agreed with the Joint Research Center (JRC), a body delegated by the European Commission.

This new version of the CoC establishes the basic rules that manufacturers of uninterruptible power supplies (UPS) located within the EU must follow for energy efficient equipment. The code has significantly increased the efficiency levels compared to the previous version, demonstrating the efforts and improvements made by the industry in recent years in line with the plea for more sustainable use of resources.

Riello UPS is proud to note that, according

to the new classification, all current Riello UPS transformer-free double conversion ON LINE UPS from 1 kVA upwards exceed the requirements of the highest level of energy efficiency identified as "Elite". This is an important recognition and an incentive to continue investing in research and the introduction of increasingly efficient models.

The "Elite" level, which will distinguish high energy efficiency UPSs, is important because it will also be used within the specific Code of Conduct for Data Centers: in fact, the parameters of the Code stipulate new Data Centers must only install UPS compliant with the "CoC for UPS Elite requirements", such as the Riello UPS range of uninterruptible power supplies.

Information on the new code of conduct can be viewed on the European Commission website at this link: <https://e3p.jrc.ec.europa.eu/communities/ict-code-conduct-ac-uninterruptiblepower-systems>

Last but not least the European Commission published a proposal for empowering the EU Directive on Energy Efficiency, aimed to strength the EU efforts to achieve energy savings in the fight against climate change.

Targeting the energy-intensive sectors the EED proposal looks to set a new framework for cooling, which should be extended to smaller energy supply installations and to service facilities and Data Centers with significant energy consumption. These requirements are likely to stimulate the use high efficiency UPSs to avoid energy waste in this sector, necessary for the decarbonisation process.



### Information about CEMEP

Officially constituted in November 2013, CEMEP is the European Committee of Manufacturers of Electrical Machines and Power Electronics. The members of CEMEP are the twelve European associations representing the producers of LV / HV electric motors, Drives and UPS. CEMEP represents a sector with a market value of € 22.4 billion and 200,000 employees. By addressing issues such as technological innovation and energy efficiency, CEMEP regulates the parameters of the power electronics industry through the Code of Conduct, thus avoiding the presence and placing on the European market of products that do not comply with current regulations.

### Information about Joint Research Center (JRC)

The Joint Research Center (JRC) is one of the 53 Directorates-General of the European Commission, which are directly funded by the European Union to provide scientific and technical support for policy design, development, implementation and monitoring. By guaranteeing the independence of research activities from private interests or from individual national policies, the JRC plays a coordinating and research role in numerous community networks bringing together national research bodies, universities and advanced industry representatives of the member states of the European Union. It makes use of the skills of the best European scientists who promote and carry out complex studies and research on behalf of the European institutions, as well as encourage collaboration with non-European and global bodies and networks in the scientific and regulatory fields.

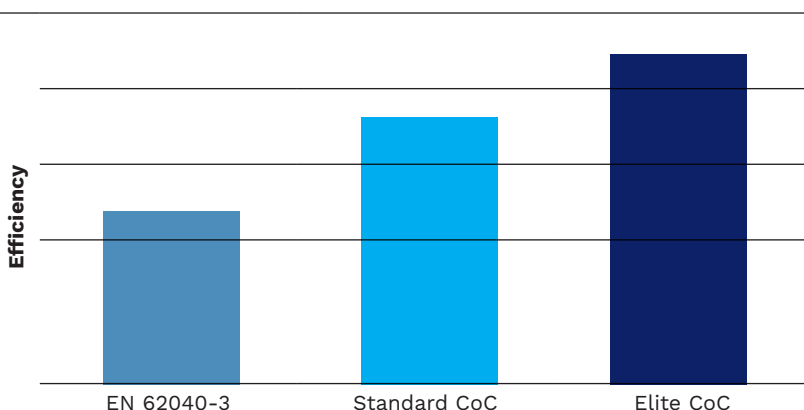

**THE ROLE OF THE UPS IN MODERN ELECTRICAL POWER GRIDS: SMART GRID READY UPS**

The ongoing evolution of electrical power grids is a key element for achieving greater sustainability. Smart Grids are fundamental to this: power management systems that balance supply with demand by using energy in the most efficient way. In essence, Smart Grids are nothing more than power grids that integrate and manage the behaviour and actions of all connected consumers, generators and output points with the aim of delivering an economically viable, safe, secure and quality electrical system. Smart Grids enable the integration of different energy sources, encourage two-way flows electricity and information and allow for centralised management. Smart Grids also introduce new business opportunities for installations of UPS. Uninterruptible power supply batteries represent a significant financial investment, but they are only partially used.

In the new Smart Grid scenario, installations with UPS can take on new roles by becoming virtual power plants. Its batteries harness the power of renewable energy sources like solar or wind and store energy that can be fed back into the grid. In order to be "Smart Grid Ready", a UPS must deliver extremely high levels of efficiency and be able to independently select the most efficient operating method depending on the real-time status of the grid. It must also be able to electronically interface with the ENERGYMANAGER across the Smart Grid communication network. Always at the forefront of technological innovation, Riello UPS has invested significant R&D to develop several Smart Grid Ready products including the NextEnergy, Multi Power, Master HE and Sentryum ranges.

With almost a decade of innovation and experience in the Smart Grid field, Riello UPS is also involved in high-profile projects such as:

- a trans-European project with RWE Supply & Trading: Master+ is a solution that enables mission-critical facilities like Data Centers or hospitals to profit from the batteries in their uninterruptible power systems by commercialising idle energy storage capacity through the energy market, minimising capital expenditure and operating costs while enhancing system reliability and fostering sustainability business approach.
- SPS, the Riello UPS Flexible Hybrid Energy Storage Family: a revolutionary product combining a UPS, a hybrid energy source (i.e. Grid and Regenerative Power Systems), energy storage and energy trading functionality in one complete solution. The flexibility of application and the quality of the SPS family has persuaded many car manufacturers companies to use it for powering their electric vehicle charging network.

These are just two of the countless examples of how Riello UPS and its technological innovations is redefining the role of the UPS and opening up new business opportunities.



**THE HUMAN FACTOR, ADDED VALUE**

The concepts of product quality and excellence are central to Riello UPS's corporate philosophy, but this is complemented with a further concept: the value of people, whether they are customers, users or colleagues. At every staff level in Riello UPS, the sense of belonging to the company and respect for others creates an excellent working environment, which is instrumental in achieving consistently exceptional results. The teamwork that leads everyone to give their best every day, collaborating

with colleagues to achieve challenging objectives is the result of the careful selection, management and training of staff and above all due to a healthy attitude of sharing targets at all levels and an ethical belief in added value. One of the secrets of Riello UPS's success is the reciprocal respect for each person's contributions and the collective effort to ensure the best levels of service and customer satisfaction. The countless awards we receive are proof of this, such as the accolade from Frost & Sullivan.



RIELLO ELETTRONICA

**riello ups**



# ***DUCATI*** CORSE ***WORLD CH***

High performance, **Unlimited**  
These are the values



**Riello UPS is the main sponsor of the Aruba.it Racing - Ducati Team.**

The collaboration best represents the Riello UPS philosophy, which in partnership with Aruba.it and Ducati, produces a close-knit and productive team that achieves goals and results of absolute excellence.

Main Sponsor



# PERFECT SYNERGY

RIELLO UPS AND DUCATI TOGETHER SINCE 2007

# CHAMPIONS

Energy, **Italian** technology. We share with Ducati.



Official Sponsor

**Riello UPS is the official sponsor of the Ducati Corse MotoGP Team.** Our partnership with Ducati provides Riello UPS with high levels of visibility and worldwide prestige. The two companies share values and principles that unite them in perfect synergy.

# Options and accessories compatibility table

Easily identify the UPS that supports the software and accessories your installation requires.

| UPS                        | Software                                      |   | Specifications |         |         |       |               |                    |              |                  |                   |
|----------------------------|---|---|----------------|---------|---------|-------|---------------|--------------------|--------------|------------------|-------------------|
|                            | POWERSHIELD <sup>3</sup><br>Shutdown software | POWERNETGUARD<br>Inventory manager software | 1 - 1          | 1/3 - 1 | 1/3 - 3 | 3 - 3 | Manual bypass | Internal batteries | Parallelable | Transformer-free | Transformer based |
| iPLUG                      | ●   |   | ●              |         |         |       |               | ●                  |              | ●                |                   |
| iDIALOG                    | ●   |   | ●              |         |         |       |               | ●                  |              | ●                |                   |
| iDIALOG RACK               | ●   |   | ●              |         |         |       |               | ●                  |              | ●                |                   |
| NET POWER                  | ●   | ⓁⓅ  | ●              |         |         |       |               | ●                  |              | ●                |                   |
| VISION                     | ●   | ●   | ●              |         |         |       |               | ●                  |              | ●                |                   |
| VISION RACK                | ●   | ●   | ●              |         |         |       |               | ●                  |              | ●                |                   |
| VISION DUAL                | ●   | ●   | ●              |         |         |       |               | ●                  |              | ●                |                   |
| SENTINEL PRO               | ●   | ●   | ●              |         |         |       |               | ●                  |              | ●                |                   |
| SENTINEL RACK              | ●   | ●   | ●              |         |         |       |               | ●                  |              | ●                |                   |
| SENTINEL DUAL SDH          | ●   | ●   | ●              |         |         |       |               | ●                  |              | ●                |                   |
| SENTINEL DUAL SDU          | ●   | ●   | ●              | ⓕ       |         |       |               | ●                  | ●            | ●                |                   |
| SENTINEL TOWER             | ●   | ●   | ●              | ⓕ       |         |       | ●             | ●                  | ●            | ●                |                   |
| SENTRYUM                   | ●   | ●   |                | Ⓢ       |         | ●     | ●             | ●                  | ●            | ●                |                   |
| MULTI SENTRY               | ●   | ●   |                |         |         | ●     | ●             |                    | ●            | ●                |                   |
| NEXTENERGY                 | ●   | ●   |                |         |         | ●     | ●             |                    | ●            | ●                |                   |
| MASTER MPS                 | ●   | ●   |                | Ⓒ       |         | ●     | ●             |                    | ●            |                  | ●                 |
| MASTER HP and MASTER HE    | ●   | ●   |                |         |         | ●     | ●             |                    | ●            |                  | ●                 |
| MASTER INDUSTRIAL          | ●   | ●   |                | Ⓒ       |         |       | ●             |                    | ●            |                  | ●                 |
| MASTER FC400               | ●   | ●   |                |         |         | ●     |               |                    | Ⓜ            |                  | ●                 |
| EMERGENCY solution CSS 1 h | ●   | ●   |                | ●       |         | ●     | ●             |                    | ●            | ●                |                   |
| EMERGENCY solution CSS 3 h | ●   | ●   |                | Ⓒ       |         | ●     | ●             |                    | ●            |                  | ●                 |
| MULTI POWER                | ●   | ●   |                |         |         | ●     | ●             | ●                  | ●            | ●                |                   |
| MULTI POWER2               | ●   | ●   |                |         |         | ●     | ●**           |                    | ●            | ●                |                   |
| SENTRYUM RACK              | ●   | ●   |                | ●       | ●       |       | ●**           |                    | ●            | ●                |                   |
| SENTRYUM RACK MARINE       | ●   | ●   |                | ●       | ●       |       | ●**           |                    | ●            | ●                |                   |
| MULTI SOCKET PDU           | ●   |   | ●              |         |         |       | ●             | -                  | -            | -                | -                 |
| MULTI SWITCH               |   | ●   | ●              |         |         |       | -             | -                  | -            | -                | -                 |
| MULTI SWITCH ATS           | ●   |   | ●              |         |         |       | -             | -                  | -            | -                | -                 |
| MASTER SWITCH STS 1 ph     | ●   |   | ●              |         |         |       | -             | -                  | -            | -                | -                 |
| MASTER SWITCH STS 3 ph     | ●   |   |                |         |         | ●     | -             | -                  | -            | -                | -                 |

\* Compatibility needs the MultiCom 372 card in addition.

\*\* Manual bypass is only present on the Sentryum Rack Cabinet and Multi Power2 PCM and PCS cabinets.





## Key

|          |                       |
|----------|-----------------------|
| <b>F</b> | 8 - 10 kVA            |
| <b>G</b> | 3 ph input only       |
| <b>H</b> | Except 30 kVA         |
| <b>L</b> | 1000 - 1500 - 2000 VA |

|          |  |
|----------|--|
| <b>N</b> | up to 20 kVA 1:1                               |
| <b>O</b> | up to 60 kVA 3:3                               |
| <b>P</b> | In combination with communication card adapter |

|            |                |
|------------|----------------|
| <b>Q</b>   | 1000 - 2000 VA |
| <b>S</b>   | 10-15-20       |
| <b>opt</b> | optional       |
| <b>std</b> | standard       |

| Ports             |     |       |             |        |     | Accessories                             |   |  |                                     |   |  |  |  |                                     |                           | info                          |                       |                       |          |
|-------------------|-----|-------|-------------|--------|-----|---|---|--|-------------------------------------|---|--|--|--|-------------------------------------|---------------------------|-------------------------------|-----------------------|-----------------------|----------|
| Embedded ethernet | USB | RS232 | Dry contact | # Slot | EPO | NETMAN 208 Card - Ethernet - SNMP v1,v3 | MULTICOM 302 Card - Modbus/Jbus interface | MULTICOM 352 Card - Interface duplexer | MULTICOM 372 Card - RS232 interface | MULTICOM 384 Card - Relay I/O interface | MULTICOM 411 Profibus Protocol converter | MULTICOM 421 Profinet Protocol converter | MULTI I/O Box - Relay I/O Card & Modbus/Jbus interface | MULTIPANEL Remote Display interface | MANUAL BYPASS 16A MBB 16A | MAN. BYPASS 16A RACK MBBR 16A | MANUAL BYPASS 100A 2P | MANUAL BYPASS 125A 4P | UPS page |
|                   | ●   |       | -           |        |     |   |   |  |                                     |   |  |  |  |                                     |                           |                               |                       |                       | 24       |
|                   | ●   |       | -           |        |     |   |   |  |                                     |   |  |  |  |                                     |                           |                               |                       |                       | 28       |
|                   | ●   | ●     | -           |        | ●   | P                                       | P   | P                                      |                                     |   | P  | P  |  |                                     |                           |                               |                       |                       | 30       |
|                   | ●   | Q     | -           |        |     | LP                                      | LP  | LP                                     |                                     |   | LP                                       | LP                                       | L  |                                     |                           |                               |                       |                       | 32       |
|                   | ●   | ●     | opt         | 1      |     | ●                                       | ●   | ●                                      | ●                                   | ●                                       | ●  | ●  | ●  | ●                                   |                           |                               |                       |                       | 34       |
|                   | ●   | ●     | opt         | 1      | ●   | ●                                       | ●   | ●                                      | ●                                   | ●                                       | ●  | ●  | ●  | ●                                   |                           |                               |                       |                       | 38       |
|                   | ●   | ●     | opt         | 1      | ●   | ●                                       | ●   | ●                                      | ●                                   | ●                                       | ●  | ●  | ●  | ●                                   | ●                         | ●                             |                       |                       | 42       |
|                   | ●   | ●     | opt         | 1      | ●   | ●                                       | ●   | ●                                      | ●                                   | ●                                       | ●  | ●  | ●  | ●                                   | ●                         |                               |                       |                       | 50       |
|                   | ●   | ●     | opt         | 1      | ●   | ●                                       | ●   | ●                                      | ●                                   | ●                                       | ●  | ●  | ●  | ●                                   | ●                         |                               |                       |                       | 46       |
|                   | ●   | ●     | opt         | 1      | ●   | ●                                       | ●   | ●                                      | ●                                   | ●                                       | ●  | ●  | ●  | ●                                   | ●                         | ●                             |                       |                       | 54       |
|                   | ●   | ●     | opt         | 1      | ●   | ●                                       | ●   | ●                                      | ●                                   | ●                                       | ●  | ●  | ●  | ●                                   |                           |                               |                       |                       | 58       |
|                   | ●   | ●     | opt         | 1      | ●   | ●                                       | ●   | ●                                      | ●                                   | ●                                       | ●  | ●  | ●  | ●                                   |                           |                               | ●                     |                       | 64       |
|                   | ●   | ●     | std         | 2      | ●   | ●                                       | ●   | ●                                      |                                     | ●                                       | ●  | ●  | ●  | ●                                   |                           |                               | N                     | O                     | 68       |
|                   | ●   | ●     | opt         | 2      | ●   | ●                                       | ●   | ●                                      | ●                                   | ●                                       | ●  | ●  | ●  | ●                                   |                           |                               |                       |                       | 80       |
| ●                 | ●   |       | std         | 2      | ●   | ●                                       | ●   | ●                                      |                                     |   | ●  | ●  | ●  | ●                                   |                           |                               |                       |                       | 86       |
|                   |     | ●     | std         | 2      | ●   | ●                                       | ●   | ●                                      |                                     |   | ●  | ●  | ●  | ●                                   |                           |                               | N                     | O                     | 98       |
|                   |     | ●     | std         | 2      | ●   | ●                                       | ●   | ●                                      |                                     |   | ●  | ●  | ●  | ●                                   |                           |                               |                       |                       | 106      |
|                   |     | ●     | std         | 2      | ●   | ●                                       | ●   | ●                                      |                                     |   | ●  | ●  | ●  | ●                                   |                           |                               |                       |                       | 114      |
|                   |     | ●     | std         | 2      | ●   | ●                                       | ●   | ●                                      |                                     |   | ●  | ●  | ●  | ●                                   |                           |                               |                       |                       | 116      |
|                   | ●   | ●     | opt         | 2      | ●   | ●                                       | ●   | ●                                      |                                     |   | ●  | ●  | ●  | ●                                   |                           |                               |                       |                       | 152      |
|                   |     | ●     | std         | 2      | ●   | ●                                       | ●   | ●                                      |                                     |   | ●  | ●  | ●  | ●                                   |                           |                               |                       |                       | 152      |
| ●                 |     | opt   | opt         | 2      | ●   | ●                                       | ●   | ●                                      | ●                                   | ●                                       | ●  | ●  | ●  | ●                                   | *                         |                               |                       |                       | 118      |
|                   |     | opt   | std         | 3      | ●   | std                                     | ●   | ●                                      | ●                                   |   | ●  | ●  | ●  | ●                                   | *                         |                               |                       |                       | 128      |
|                   | ●   | ●     | std         | 2      | ●   | ●                                       | ●   | ●                                      |                                     | ●                                       | ●  | ●  | ●  | ●                                   |                           |                               |                       |                       | 136      |
|                   | ●   | ●     | std         | 2      | ●   | ●                                       | ●   | ●                                      |                                     | ●                                       | ●  | ●  | ●  | ●                                   |                           |                               |                       |                       | 140      |
|                   | ●   | ●     | -           | 1      |     | ●                                       |   |  |                                     |   |  |  |  |                                     |                           |                               |                       |                       | 162      |
|                   |     | ●     | -           | 1      |     | ●                                       |   |  |                                     |   |  |  |  |                                     |                           |                               |                       |                       | 164      |
|                   | ●   | ●     | std         | 1      |     | ●                                       | ●   | ●                                      |                                     |   | ●  | ●  |  |                                     |                           |                               |                       |                       | 168      |
|                   |     | ●     | std         | 1      |     | ●                                       | ●   | ●                                      |                                     |   | ●  | ●  |  |                                     |                           |                               |                       |                       | 172      |
|                   |     | ●     | std         |        |     | P                                       | P   | P                                      |                                     |   | P  | P  |  |                                     |                           |                               |                       |                       | 174      |

# Application areas

## one answer for each application

The critical systems that sustain your business operations can't ever go down. Riello UPS supports you in improving your uptime with a full range of innovative uninterruptible power supplies (UPS) and future-proofed, integrated UPS systems that cover the backup power needs of your installations whatever the application: from Digital Living, Medical and Transportation, through to Industrial environments and hyperscale Data Centers. Each application area comes with its own specific requirements that need to be met with a UPS delivering the most appropriate characteristics. With its large portfolio of products, Riello UPS always offers the best solution for every need. Here are some of the technical characteristics that can help you choose the right UPS:

### SMALL FOOTPRINT

Riello UPS products offer a compact footprint that enables them to be easily installed anywhere in the office workspace, Data Center, or industrial environment without creating any unnecessary interference with other workplace or customer areas.

### MINIMAL NOISE

Noise is an unwelcome distraction in any workplace. This is why our UPS are equipped with a sophisticated microprocessor control system able to reduce the speed (and noise) of the fans depending on the load and even switch them off completely when not required.

### ADVANCED COMMUNICATIONS

Riello UPS solutions are equipped with USB, RS232 and other communication ports, allowing for full management and communication functionality that helps to preserve your data and make your critical load secure.

### AVAILABILITY

According to the TIER standard, system availability should fall between 99.9% and 99.999%: downtime simply isn't an option. Using high-quality Riello UPS uninterruptible power supplies in a well-designed system, this level of availability can be easily achieved. The UPS must be versatile, compact and parallelable in order to provide the required flexibility; it must also be able to adapt to all types of load, both inductive and capacitive.

### ENERGY CONSUMPTION

For both economic and environmental reasons, reducing electricity consumption is a necessity for all businesses. It makes sense to choose a UPS supplier that offers green products designed to combine outstanding performance with the best energy efficiency and lowest environmental impact possible.

### SAFETY

Depending on the industry, there are many stringent safety standards that equipment must adhere to. Based on the type of application, the UPS must ensure immunity from external influences and provide compatibility with: IP protection levels, input/output electrical isolation, the possibility of housing internal isolation transformers and auxiliary monitoring systems. Riello UPS's product range includes solutions that comply with all relevant power and safety requirements.

### GLOBAL STRENGTH

The need to ensure service continuity requires high levels of compatibility with stringent mechanical standards (IP protection, vibrations, structural rigidity). The use of air filters, isolated electrical connectors and special wiring is often required in order to fulfil these general requirements, as well as fastening components and systems that are highly resistant to mechanical stresses. Riello UPS is able to offer tailor-made solutions that meet the regulatory requirements of even the most challenging operating conditions.

### RELIABILITY

Operational continuity is of strategic importance in the transport sector. Downtime with regards to power supply or monitoring/control information cannot be tolerated. Continuity can be guaranteed by using high-quality UPS that are versatile, technologically advanced and parallelable. Such UPS must be able to operate under the harshest environmental conditions (i.e. extreme temperatures, fluctuating power supplies and different types of load). Riello UPS products satisfy the most diverse and complex requirements to ensure operating continuity and reliability for users.





## DIGITAL LIVING AREA

The Digital Living area covers a sector that includes domestic environments, freelancers and small businesses (SOHO small office/home office) that require solutions characterised by minimal noise, low energy consumption and a compact footprint.

Riello UPS products represent the perfect choice for those who want to protect their entertainment devices, small computer networks, workstations and smart home devices from possible network disturbances and blackouts, reducing the risk of damaging data losses.

### CHARACTERISTICS

#### Low power consumption

The containment of energy consumption is a necessity, as well as a moral obligation towards the wider environment. It is therefore essential to choose a UPS that provides protection, power quality and maximum performance while ensuring the least possible environmental impact.

#### Small footprint

Thanks to their compact size, UPSs can be positioned in office environments without creating any interference with customer premises. Small solutions that can be installed in rack cabinets are also available.

#### Minimal noise

Noise is one of the key characteristics that can make the difference for equipment in homes and offices. Our UPSs are equipped with microprocessors capable of automatically controlling and reducing the speed of the fans, or even switching them off if necessary.

#### Advanced communication

Riello UPS solutions are equipped with multiple communication ports that allow complete management and communication to preserve data and ensure the safety of critical systems.

### APPLICATIONS

- > Home office and Smart Home;
- > Gaming;
- > Audio/Visual equipment;
- > Home security systems;
- > Public administration;
- > Point of Sale (POS);
- > Security systems.

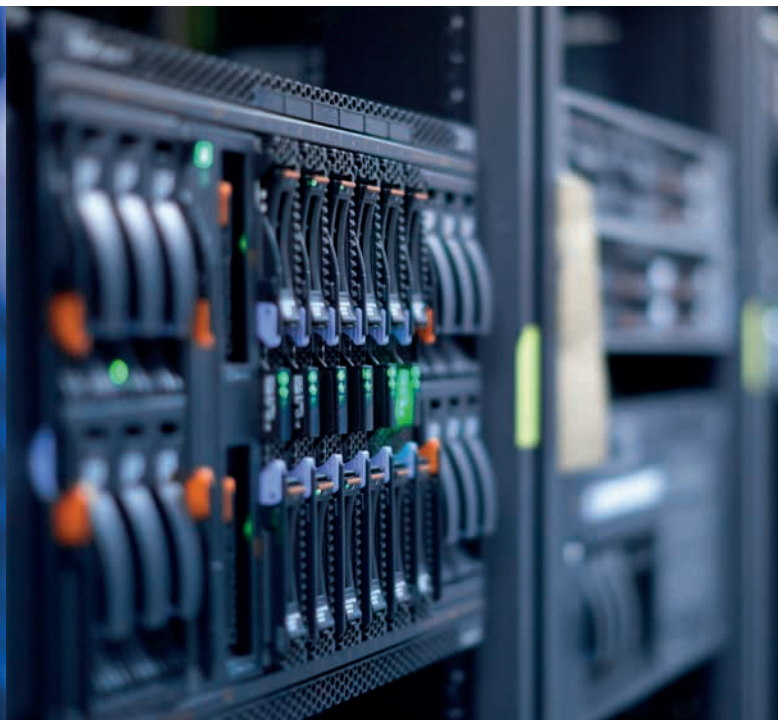

## DATA CENTER AREA

The volume of digital data that needs to be processed and stored (IoT, financial transactions, e-commerce, leisure, games, online trading, 5G, etc.), is growing exponentially, which is why data centers must be sustainable, scalable and resilient to adapt to this evolving situation.

It is essential to ensure functionality and reliability, starting with the correct design of the electrical continuity system.

Choosing a Riello UPS solution guarantees a reduction in total cost of ownership (TCO), offers installation flexibility and ensures resource optimisation, all while delivering maximum sustainability and resilience.

### CHARACTERISTICS

#### High availability

According to the TIER Classification System defined by the Uptime Institute, system availability within a data center must be between 99.9% and 99.999%: downtime is not an option. By using high quality Riello UPS products, in a properly designed system, this kind of availability can be easily achieved. Our UPSs are versatile and compact, parallelable to offer the necessary flexibility and adaptable to all types of loads, both inductive and capacitive; they are also able to integrate seamlessly with the other elements of the system (e.g. generator sets).

#### Energy consumption

The containment of energy consumption is a necessity for all organisations, as well as a moral obligation towards the environment.

Therefore, it is essential to choose a UPS supplier who knows how to offer “green” products designed to obtain maximum energy efficiency with the least environmental impact, all while delivering the highest levels of performance.

Riello UPS uninterruptible power supplies comply with the highest levels of efficiency in energy protection and are evaluated as “Elite” according to the classification system of the CoC (Code of Conduct) according to their degree of energy efficiency.

#### Scalability and functionality

A UPS must offer high levels of scalability, whatever the architectural design of the data center. This allows for proper sizing during initial installation, reducing upfront costs and optimising the overall TCO.

Riello UPS uninterruptible power supplies allow you to achieve “pay as you grow” scalability which can be implemented both horizontally, by adding side-by-side or back-to-back monolithic UPSs and vertically by adding power modules or cabinets to modular solutions. Adding new UPSs, cabinets, or power modules must also ensure an improvement in the UPS and a reduction in MTTR (Mean Time to Repair) and possible downtime.

#### APPLICATIONS

- > **Server farms;**
- > **Small, medium and large data centers, multi-tenant, colocation and hyperscale;**
- > **Telecommunications;**
- > **Businesses and financial institutions.**



## E-MEDICAL AREA

Health and medical facilities, whether they are hospitals or private clinics, are faced with an ever-greater demand for electricity protection.

For this reason, power continuity must always be supported and ensured with the use of flexible supervision and control systems that can be adapted to the multiple systems present in healthcare infrastructures.

Riello UPS solutions guarantee total flexibility and safety by taking into account all applicable legislative provisions (i.e. compliance with specific standards) whilst at the same time respecting the patients' right to health and personal data protection.

### CHARACTERISTICS

#### Extreme protection for critical applications

When life is in danger, healthcare personnel must be able to focus solely on the patient and be sure that the energy continuity of the medical control equipment is always guaranteed. State-of-the-art Riello UPS power systems, always available and efficient, protect medical equipment and help reduce overall operating costs by optimising energy use.

#### High resilience

Resilience is a concept that derives from the combination of resistance and flexibility: it is the ability to tolerate any failures, to dynamically adapt to the required workloads and to always guarantee maximum operational reliability. It is essential for healthcare facilities managers to be able to rely on scalable products that allow them to manage any future load requirements without any repercussions on their existing systems.

#### Compliance with specific standards

The solutions offered by Riello UPS for healthcare facilities meet the most stringent standards and include products suitable for various power and safety needs.

### APPLICATIONS

- > **Back-up of auxiliary power systems;**
- > **Electrical substations at hospital complexes;**
- > **Technical rooms of the operating theatres;**
- > **Emergency lighting systems.**



## INDUSTRIAL AREA

Industrial plants are often connected to electrical networks that are not always stable. This can cause damage to the equipment and in the most serious cases even interrupt time-sensitive and expensive production cycles.

In these cases, the UPS represents a fundamental aspect to guarantee continuity of the services provided, as well as the safety of the systems and of those who use them.

Riello UPS solutions for industrial use have been used for years in challenging environmental situations (high temperatures, vibrations and humidity) and with the utmost respect for the strictest mechanical and safety standards (IP protection or structural rigidity).

### CHARACTERISTICS

#### Maximum reliability

Business continuity in the industrial sector is essential and the interruption in the supply of energy and information related to monitoring/control is not acceptable.

For this reason, relying on Riello UPS uninterruptible power supplies is a priority: they are versatile, technologically advanced and suitable for operation in very harsh environmental conditions such as high temperatures, humidity, vibrations, or supply voltages with fluctuations.

#### Robustness

Riello UPS uninterruptible power supplies are designed to withstand actions of different types and intensities, always compatible with stringent mechanical standards. A robust design makes them suitable for use in harsh environments, in the presence of high temperatures, dust, humidity, corrosive contaminants, etc.

#### Flexibility and customisation

Riello UPSs are flexible, i.e. adaptable to different power sources (single-phase, three-phase, with or without neutral connection), configurable with isolation transformers (not only on the output but also on the rectifier and bypass), compatible with various communication protocols for remote control and monitoring of the equipment and customisable according to the specific needs of the plant and the customer.

### APPLICATIONS

- > **Extreme environmental conditions: very high or low temperatures, dust, high humidity, strong winds, high possibility of floods or earthquakes, installations in remote areas of the planet;**
- > **Ventilation systems;**
- > **Cyber-physical systems (CPS) composed of integrated IT systems and networks of devices that monitor and control physical processes by means of periodic loops and feedback;**
- > **Human-machine interfaces (HMI) with which workers are integrated into the interconnection between business processes and data flows in real-time;**
- > **Industrial Internet of Things (IIoT) consisting of intelligent machines, devices, workers, companies and customers;**
- > **Cloud computing to have hardware and software resources available as on demand services via the network;**
- > **Process simulation systems;**
- > **Robotics;**
- > **3D printing;**
- > **RFID for unambiguous, automatic, massive and remote detection of objects, based on the propagation of electromagnetic waves in the air.**



## TRANSPORT AREA

In recent years we have witnessed a growing demand for the transport of both goods and passengers: it is therefore of fundamental importance that the systems connected to them, such as digital services and hardware infrastructures are reliable, efficient and sustainable.

The use of Riello UPS solutions makes it possible to protect and constantly monitor all the electrical equipment supporting these systems and infrastructures, taking into account the most complex environmental conditions while at the same time guaranteeing compliance with the most stringent regulations.

### CHARACTERISTICS

#### Installation flexibility

Each application in the transport infrastructure sector responds to particular reference standards. For Riello UPS it is essential to always offer solutions that are adaptable to various power sources (single-phase, three-phase, with or without neutral connection), are compatible with the various communication protocols for complete, rapid and effective remote control and which allow frontal access to facilitate input/output wiring, parts replacement and preventative maintenance.

#### Overall robustness

Riello UPS uninterruptible power supplies are designed to withstand actions of different types and intensities, but always compatible with stringent mechanical standards. A robust design makes them suitable for use in harsh environments in the presence of high temperatures, dust, humidity, corrosive contaminants, etc. Riello UPS uses technologies suitable for the various degrees of IP protection (for example IP protection levels > 21), vibration and structural rigidity; uses, where necessary, additional air filters, insulated electrical connectors, tropicalised electronic boards, special wiring (halogen free, etc.) and fixing systems resistant to mechanical stress.

#### Reliability

A transport company must be able to guarantee and plan its continuity of operations in any circumstance: disruption of the energy supply or the information relating to the monitoring and control of its equipment, even if only short, is not tolerable. This can be avoided by using high quality, versatile, technologically advanced and parallelable UPSs, which can operate in harsh and challenging environmental conditions. With its line of transformer-free or transformer-based products, Riello UPS satisfies the most varied and complex needs, ensuring continuity of operation and peace of mind for the user and for the plant managers.

### APPLICATIONS

- > **Infrastructures for customer experience applications that improve the user experience by following them in every aspect of their journey;**
- > **Remote diagnostics for dynamic and predictive maintenance of the systems;**
- > **Ventilation systems;**
- > **Intelligent traffic management systems;**
- > **Systems that require installation flexibility to meet the different standards of the various transport infrastructures;**
- > **Automation systems;**
- > **Satellite communications;**
- > **Infrastructures for energy distribution;**
- > **On board control and monitoring systems;**
- > **Telecommunication systems for logistics and transport infrastructures;**
- > **Smart city and public transport, traffic, or mobility monitoring, including for merchant or cruise ships.**

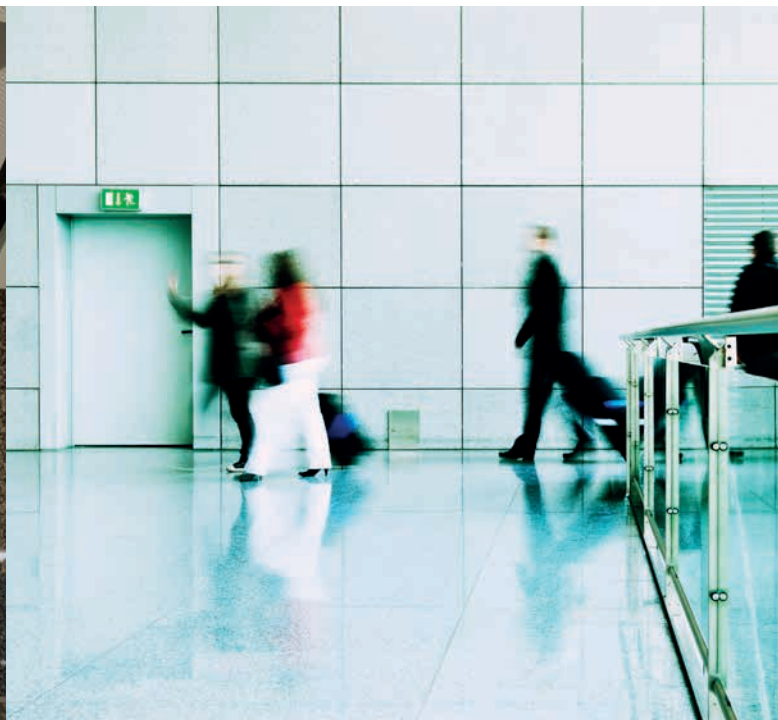

## EMERGENCY AREA

Emergency systems such as fire systems, emergency lighting, alarm units and any other safety-oriented equipment are vital for all facilities, whether they are commercial rather than manufacturing plants or medical facilities. These buildings often have particularly strict rules and regulations regarding power and service continuity. Riello UPS CPSSs (Centralised Power Supply Systems) comply with the EN50171 standard and guarantee the correct level of autonomy for these systems, integrating an advanced diagnostic system inside them which is the result of many years of experience in this specific sector.

### CHARACTERISTICS

- Compliance with EN60598-1;
- Autonomy up to 3 hours (more on request when necessary);
- Battery life up to 10 years (for temperatures at 20 °C);
- Input/output galvanic isolation (optional);
- Advanced diagnostics (data accessible from a remote device);
- Interface device for sending and sharing data in real-time;
- High short circuit current.

### APPLICATIONS

- > **Emergency lighting;**
- > **Automatic fire extinguishing systems;**
- > **Alarm and emergency detection unit;**
- > **Fume extraction equipment;**
- > **Carbon monoxide detection systems;**
- > **Specific safety systems in sensitive areas.**





**UPS**





# iPlug

1:1 600-800 VA



UPS VFD



Tower



Plug & Play installation



USB plug



## HIGHLIGHTS

- **Compact**
- **Versatile**
- **Robust**
- **Contemporary design**
- **Auto restart**
- **Battery swap**

The iPlug series is the ideal solution for protecting household and small office systems. Its compact size and versatility (push-button operation, LED status panel and user replaceable batteries), make iPlug easy to install within a domestic environment to protect systems from surges and blackouts. When the mains fails, the load is powered from a pseudo-sine wave inverter, to provide sufficient runtime for computer system shutdown using PowerShield<sup>3</sup> software, which can be downloaded free from [www.riello-ups.com](http://www.riello-ups.com)

### VERSATILE, ROBUST AND CONTEMPORARY DESIGN

The iPlug's compact and ergonomic design allow it to be easily installed in professional and domestic environments. iPlug is extremely versatile and its innovative cable management feature ensures a tidy, easy to manage installation.

### ADVANCED COMMUNICATIONS

PowerShield<sup>3</sup> software allows for the safe shutdown of connected IT systems on mains power supply failure. PowerShield<sup>3</sup> provides efficient and intuitive UPS management using bar chart displays for important operating information.



## AUTO RESTART

The UPS automatically restarts upon the restoration of mains power after having shut down once the batteries have run out following a black out (Auto restart).

## ENVIRONMENTAL PROTECTION ECO LINE

With energy savings in mind, the iPlug range features a shut-off button to reduce energy consumption during periods of prolonged inactivity.

## APPLICATIONS

LCD monitors, personal computers, video terminals, printers, scanners and fax machines.

## FEATURES

- Compact and ergonomic;
- 5 sockets protected against blackouts;
- 3 sockets protected against overvoltage for the supply of loads with larger absorption loads e.g laser printers;
- Ability to switch on the UPS without a mains power supply (Cold Start);
- User replaceable batteries (Battery Swap);
- USB interface;
- Floor-standing or desktop installation;
- Power-supply cable included;
- Built-in short circuit protection;
- Auto restart (when mains power is restored, after discharge of the batteries);
- GS/Nemko safety seal;
- Available with French (2P+T), British, Schuko and Italian outlets;
- PowerShield<sup>3</sup> supervision and shutdown software for Windows operating systems 11, 10, 8, Server 2022, 2019, 2016 and previous versions, Windows Server Virtualization Hyper-V, macOS, Linux, Citrix XenServer and other Unix operating systems;
- Plug and play function.

## 2-YEAR WARRANTY

## CONFIGURATOR FOR MODEL SELECTION

| Load type   | VA power rating <sup>1</sup> |
|---|------------------------------|
| Personal computers  | 250                          |
| LCD Monitors  | 70                           |
| Scanners, printers  | 200                          |
| Modems, TVs, DVD players, PlayStations, Hi-Fi systems, Telephones | 50                           |
| Laser printers <sup>2</sup>                                       | 200                          |

<sup>1</sup> Estimated average value.

<sup>2</sup> iPlug filtered output power supply is recommended.

## OPTIONS

### SOFTWARE

PowerShield<sup>3</sup>

## AVAILABLE SOCKETS

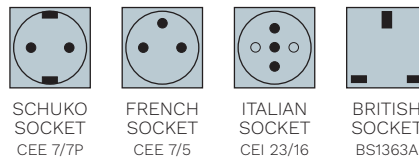

## DETAILS

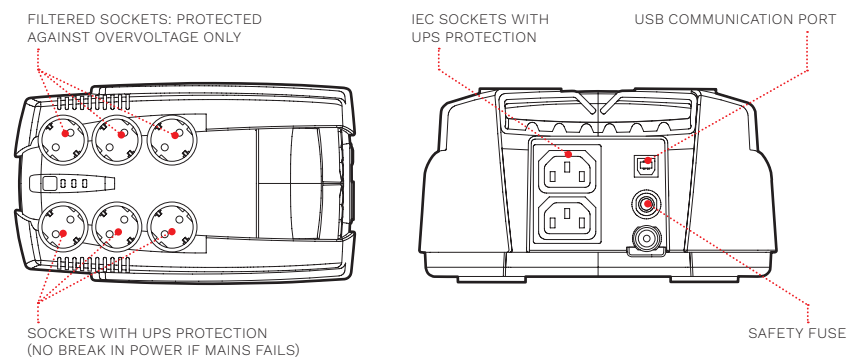

| <b>MODELS</b>                            | <b>IPG 600</b>   | <b>IPG 800</b>      |
|--|--|---------------------|
| <b>POWER</b>                             | <b>600 VA/360 W</b>  | <b>800 VA/480 W</b> |
| <b>INPUT</b>                             |  |                     |
| Rated voltage [V]                        | 220 / 230 / 240  |                     |
| Voltage tolerance [V]                    | 230 (+20/-25%)   |                     |
| Rated frequency [Hz]                     | 50 / 60 with automatic selection   |                     |
| <b>OUTPUT</b>                            |  |                     |
| Voltage during mains operation [V]       | 230 (+20/-25%)   |                     |
| Voltage during battery operation [V]     | 230 (±10%)   |                     |
| Frequency during battery operation [Hz]  | 50 or 60 (±1%)   |                     |
| Waveform                                 | Pseudo Sinusoidal  |                     |
| <b>BATTERIES</b>                         |  |                     |
| Type                                     | VRLA AGM maintenance-free lead based   |                     |
| Recharge time                            | 6-8 h  |                     |
| <b>OVERALL SPECIFICATIONS</b>            |  |                     |
| Net weight [kg]                          | 3.7  | 4.1                 |
| Gross weight [kg]                        | 4  | 4.4                 |
| Dimensions (WxDxH) [mm]                  | 185x313x99   |                     |
| Packaging dimensions (WxDxH) [mm]        | 260x380x140  |                     |
| Protections                              | Excessive low battery - overvoltage - short circuit  |                     |
| Communications                           | USB  |                     |
| Output sockets                           | 6 sockets (Schuko or Italian or French or British) + 2x IEC 320 C13 (10 A)   |                     |
| Standards                                | European directives: LV 2014/35/EU low voltage Directive; EMC 2014/30/EU electromagnetic compatibility Directive<br>Standards: Safety IEC EN 62040-1; EMC IEC EN 62040-2; RoHS compliant |                     |
| Certificates                             | CE; GS/NEMKO on Schuko version   |                     |
| Colour                                   | RAL 9005   |                     |
| Ambient temperature for the UPS          | 0 °C - +40 °C  |                     |
| Recommended temperature for battery life | +20 °C - +25 °C  |                     |
| Range of relative humidity               | 5-95% non-condensing   |                     |
| Storage temperature                      | From -25 °C up to 60 °C (UPS) / From -15 °C up to +40 °C (for the batteries)   |                     |
| Equipment provided                       | power cable, user guide  |                     |





# iDialog

1:1 400-1600 VA



UPS VFD



Tower



Plug & Play installation



USB plug



## HIGHLIGHTS

- **Compact**
- **Silent operation**
- **Contemporary design**
- **Auto restart**
- **Low power consumption**

The iDialog range is the ideal solution for protecting PCs and peripherals in the home and office. iDialog is easy to install and economic to run for protecting:

- IT equipment such as PCs, Media Centers and peripherals, TVs, Home Cinema systems, Satellite and Digital Terrestrial Receivers and Digital Living devices;
- xDSL modems and routers;
- Small home appliances.

### SILENT OPERATION

The UPS is silent in operation (0 dBA) thanks to its use of a fan-free design and high frequency components.

### ADVANCED COMMUNICATIONS

PowerShield<sup>3</sup> software allows for the safe

shutdown of connected IT systems on mains power supply failure. PowerShield<sup>3</sup> provides efficient and intuitive UPS management using bar chart displays for important operating information.

### AUTO RESTART

The UPS automatically restarts when the mains power supply is restored.

### ECO LINE ENVIRONMENTAL PROTECTION

With energy savings in mind, the iDialog range features a shut-off button to reduce energy consumption during periods of prolonged inactivity.

### FEATURES

- Reduced energy consumption and 99% efficiency;



- Maximum reliability and protection of PCs thanks to PowerShield<sup>3</sup> monitoring and shutdown software, which can be downloaded free at [www.riello-ups.com](http://www.riello-ups.com);
- Can be installed on PCs with Windows operating systems 11, 10, 8, Server 2022, 2019, 2016 and previous versions, Windows Server Virtualization Hyper-V, macOS, Linux, Citrix XenServer and other Unix operating systems;
- Small size: With its compact shape, iDialog can be placed anywhere on the desk or in the home;
- Silent: iDialog is also suitable for protecting your non-professional digital equipment such as home cinema systems, satellite and digital terrestrial receivers and Digital Living devices.

## OPTIONS

### SOFTWARE

PowerShield<sup>3</sup>

## DETAILS

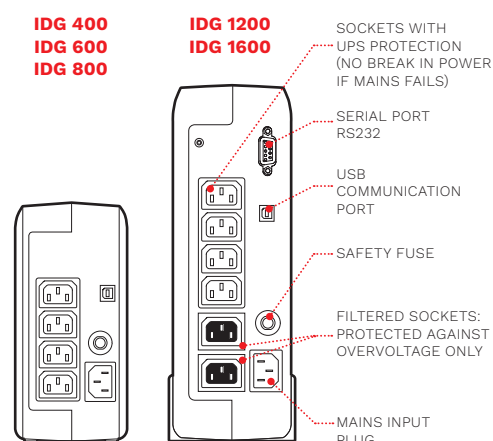

## 2-YEAR WARRANTY

| MODELS                                   | IDG 400   | IDG 600             | IDG 800             | IDG 1200              | IDG 1600             |
|--|---|---------------------|---------------------|-----------------------|----------------------|
| <b>POWER</b>                             | <b>400 VA/240 W</b>   | <b>600 VA/360 W</b> | <b>800 VA/480 W</b> | <b>1200 VA/720 W</b>  | <b>1600 VA/960 W</b> |
| <b>INPUT</b>                             |   |                     |                     |                       |                      |
| Rated voltage [V]                        | 220 / 230 / 240   |                     |                     |                       |                      |
| Voltage tolerance [V]                    | 230 (+20/-25%)  |                     |                     |                       |                      |
| Rated frequency [Hz]                     | 50 / 60 with automatic selection  |                     |                     |                       |                      |
| <b>OUTPUT</b>                            |   |                     |                     |                       |                      |
| Voltage during mains operation [V]       | 230 (+20/-25%)  |                     |                     |                       |                      |
| Voltage during battery operation [V]     | 230 (±10%)  |                     |                     |                       |                      |
| Frequency during battery operation [Hz]  | 50 or 60 (±1%)  |                     |                     |                       |                      |
| Waveform                                 | Pseudo Sinusoidal   |                     |                     |                       |                      |
| <b>BATTERIES</b>                         |   |                     |                     |                       |                      |
| Type                                     | VRLA AGM maintenance-free lead based  |                     |                     |                       |                      |
| Recharge time                            | 6-8 h   |                     |                     |                       |                      |
| <b>OVERALL SPECIFICATIONS</b>            |   |                     |                     |                       |                      |
| Net weight [kg]                          | 3.2   |                     | 3.4                 | 6.6                   | 6.9                  |
| Gross weight [kg]                        | 3.7   |                     | 4.1                 | 8.1                   | 8.6                  |
| Dimensions (WxDxH) [mm]                  | 90x232x192  |                     |                     | 93x310x270            |                      |
| Packaging dimensions (WxDxH) [mm]        | 138x300x278   |                     |                     | 170x400x370           |                      |
| Protections                              | Excessive low battery - overvoltage - short circuit   |                     |                     |                       |                      |
| Communications                           | USB   |                     |                     | USB + RS232           |                      |
| Output sockets                           | 4x IEC 320 C13 (10 A)   |                     |                     | 6x IEC 320 C13 (10 A) |                      |
| Standards                                | European directives: LV 2014/35/EU low voltage Directive; EMC 2014/30/EU electromagnetic compatibility Directive Standards: Safety IEC EN 62040-1; EMC IEC EN 62040-2; RoHS compliant |                     |                     |                       |                      |
| Certificates                             | CE  |                     |                     |                       |                      |
| Operating temperature                    | 0 °C / +40 °C   |                     |                     |                       |                      |
| Colour                                   | RAL 9005  |                     |                     |                       |                      |
| Ambient temperature for the UPS          | 0 °C - +40 °C   |                     |                     |                       |                      |
| Recommended temperature for battery life | +20 °C - +25 °C   |                     |                     |                       |                      |
| Range of relative humidity               | 5-95% non-condensing  |                     |                     |                       |                      |
| Standard equipment                       | 2 output power supply cables, user manual   |                     |                     |                       |                      |



# iDialog Rack

1:1 600-1200 VA



UPS VFD



Rack



Plug & Play installation



USB plug



## HIGHLIGHTS

- **Designed for telco racks**
- **Silent operation**
- **Auto restart**
- **Low power consumption**

### MAXIMUM RELIABILITY IN THE PROTECTION OF VOIP SYSTEMS

The iDialog Rack range is the ideal solution for protecting PCs and peripherals in the home and office. iDialog Rack is easy to install and economic to run for protecting:

- IT equipment such as PCs, Media Centers and peripherals, TVs, Home Cinema systems, Satellite and Digital Terrestrial Receivers and Digital Living devices;
- xDSL modems and routers;
- Voip and network application.

### SILENT OPERATION

The UPS is silent in operation (0 dBA) thanks to its use of a fan-free design and high frequency components.

### ADVANCED COMMUNICATIONS

PowerShield<sup>3</sup> software allows for the safe shutdown of connected IT systems on mains power supply failure. PowerShield<sup>3</sup> provides efficient and intuitive UPS management using bar chart displays for important operating information.

### AUTO RESTART

The UPS automatically restarts when the mains power supply is restored.

### ECO LINE ENVIRONMENTAL PROTECTION

With energy savings in mind, the iDialog Rack range features a shut-off button to reduce energy consumption during periods of prolonged inactivity.





## FEATURES

- Reduced energy consumption and 99% efficiency;
- Maximum reliability and protection of PC s thanks to PowerShield<sup>3</sup> monitoring and shutdown software, which can be downloaded free at [www.riello-ups.com](http://www.riello-ups.com);
- Can be installed on PCs with Windows operating systems 11, 10, 8, Server 2022, 2019, 2016 and previous versions, Windows Server Virtualization Hyper-V, macOS, Linux, Citrix XenServer and other Unix operating systems;
- Small size: with its compact shape, iDialog Rack can be placed in any small rack;
- Noise-free running: iDialog Rack is also suitable for protecting your non-professional digital equipment such as home cinema systems, satellite and digital terrestrial receivers and Digital Living devices.

## DETAILS

### IDR 600 - IDR 1200

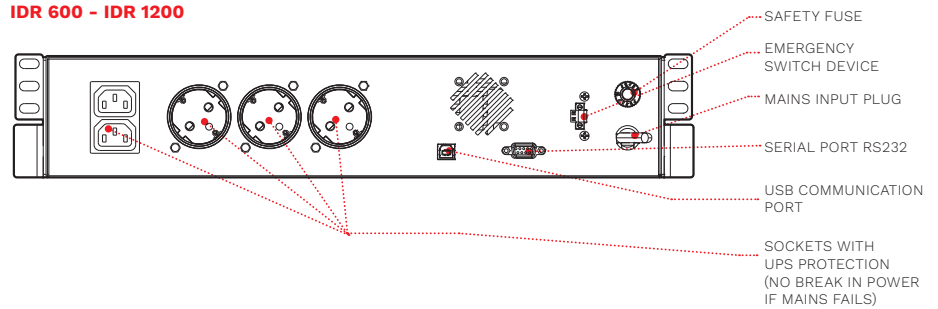

## OPTIONS

### SOFTWARE

PowerShield<sup>3</sup>

### ACCESSORIES

NETMAN 208 + box

MULTICOM 302 + box

## 2-YEAR WARRANTY

| MODELS                                   | IDR 600  | IDR 1200             |
|--|--|----------------------|
| <b>POWER</b>                             | <b>600 VA/360 W</b>  | <b>1200 VA/720 W</b> |
| <b>INPUT</b>                             |  |                      |
| Rated voltage [V]                        | 220 / 230 / 240  |                      |
| Voltage tolerance [V]                    | 230 (+20/-25%)   |                      |
| Rated frequency [Hz]                     | 50 / 60 with automatic selection   |                      |
| <b>OUTPUT</b>                            |  |                      |
| Voltage during mains operation [V]       | 230 (+20/-25%)   |                      |
| Voltage during battery operation [V]     | 230 (±10%)   |                      |
| Frequency during battery operation [Hz]  | 50 or 60 (±1%)   |                      |
| Waveform                                 | Pseudo Sinusoidal  |                      |
| <b>BATTERIES</b>                         |  |                      |
| Type                                     | VRLA AGM maintenance-free lead based   |                      |
| Recharge time                            | 6-8 h  |                      |
| <b>OVERALL SPECIFICATIONS</b>            |  |                      |
| Net weight [kg]                          | 5.5  | 9                    |
| Gross weight [kg]                        | 7  | 10.5                 |
| Dimensions (WxDxH) [mm]                  | 438x230x87   | 438x300x87           |
| Packaging dimensions (WxDxH) [mm]        | 503x330x211  | 503x400x211          |
| Protections                              | Excessive low battery - overvoltage - short circuit  |                      |
| Communications                           | USB + RS232  |                      |
| Output sockets                           | 2x IEC 320 C13 (10 A) + 3 Shuko  |                      |
| Standards                                | European directives: LV 2014/35/EU low voltage Directive EMC 2014/30/EU electromagnetic compatibility Directive Standards: Safety IEC EN 62040-1; EMC IEC EN 62040-2; RoHS compliant |                      |
| Certificates                             | CE   |                      |
| Colour                                   | RAL 9005   |                      |
| Ambient temperature for the UPS          | 0 °C - +40 °C  |                      |
| Recommended temperature for battery life | +20 °C - +25 °C  |                      |
| Range of relative humidity               | 5-95% non-condensing   |                      |
| Standard equipment                       | Rack handles, user manual  |                      |



# Net Power

1:1 600-2000 VA



LINE INTERACTIVE



Tower



Plug & Play installation



USB plug



## HIGHLIGHTS

- **Automatic Voltage Regulation (AVR)**
- **Advanced communications**
- **Automatic battery test**

The Net Power series is available in 600-2000 VA models. When the load is supplied from the mains, the automatic voltage regulator (AVR) and EMI filters stabilise power and suppress atmospheric disturbances. When the mains fails, the load is powered from a pseudo-sine wave inverter, to provide sufficient runtime for computer system shutdown using PowerShield<sup>3</sup> software, which can be downloaded free from [www.riello-ups.com](http://www.riello-ups.com)

### FEATURES

- Stabilisation and filtering of the mains power supply using AVR and EMI filters for the suppression of atmospheric disturbances;
- Ability to switch on the UPS in the absence of mains power (Cold Start);

- High reliability with built-in battery test
- Auto restart (when mains power is restored, after discharge of the batteries);
- Supplied with two IEC cables for powering the loads.

### ADVANCED COMMUNICATIONS

- Advanced multi-platform communications for all operating systems and network environments: PowerShield<sup>3</sup> supervision and shutdown software for Windows operating systems systems 11, 10, 8, Server 2022, 2019, 2016 and previous versions, Windows Server Virtualization Hyper-V, macOS, Linux, Citrix XenServer and other Unix operating systems;
- Standard USB interface, RS232 on models 1000 - 1500 - 2000.

### 2-YEAR WARRANTY



## OPTIONS

### SOFTWARE

PowerShield<sup>3</sup>

### ACCESSORIES

NETMAN 208 + box  
(only NPW 1000-1500-2000)

MULTICOM 302 + box  
(only NPW 1000-1500-2000)

## DETAILS

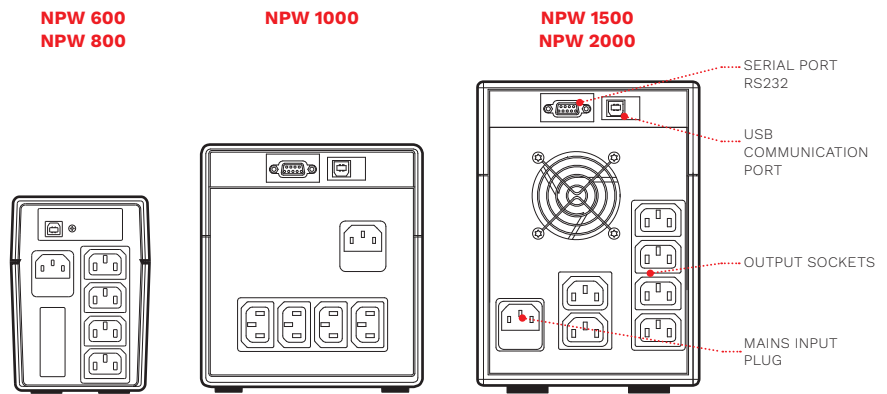

| MODELS                                   | NPW 600  | NPW 800             | NPW 1000             | NPW 1500              | NPW 2000              |
|--|--|---------------------|----------------------|-----------------------|-----------------------|
| <b>POWER</b>                             | <b>600 VA/360 W</b>  | <b>800 VA/480 W</b> | <b>1000 VA/600 W</b> | <b>1500 VA/900 W</b>  | <b>2000 VA/1200 W</b> |
| <b>INPUT</b>                             |  |                     |                      |                       |                       |
| Rated voltage [V]                        | 220 / 230 / 240  |                     |                      |                       |                       |
| Voltage tolerance [V]                    | 230 (±25%)   |                     |                      |                       |                       |
| Rated frequency [Hz]                     | 50 / 60 with automatic selection   |                     |                      |                       |                       |
| <b>OUTPUT</b>                            |  |                     |                      |                       |                       |
| Voltage during mains operation [V]       | 230 (-8%, +10%)  |                     |                      |                       |                       |
| Voltage during battery operation [V]     | 230 (±5%)  |                     |                      |                       |                       |
| Frequency during battery operation [Hz]  | 50 or 60 (±0.5%)   |                     |                      |                       |                       |
| Battery waveform                         | Pseudo sinusoidal  |                     |                      |                       |                       |
| <b>BATTERIES</b>                         |  |                     |                      |                       |                       |
| Type                                     | VRLA AGM maintenance-free lead based   |                     |                      |                       |                       |
| Recharge time                            | 6-8 h  |                     | 2-4 h                |                       |                       |
| <b>OVERALL SPECIFICATIONS</b>            |  |                     |                      |                       |                       |
| Net weight [kg]                          | 4.3  | 4.9                 | 8                    | 11.1                  | 11.5                  |
| Gross weight [kg]                        | 5.6  | 6.3                 | 10                   | 13.5                  | 14                    |
| Dimensions (WxDxH) [mm]                  | 100x287x142  |                     | 146x350x160          | 146x397x205           |                       |
| Packaging dimensions (WxDxH) [mm]        | 140x332x220  |                     | 195x440x250          | 230x480x280           |                       |
| Protections                              | Excessive low battery - overvoltage - short circuit  |                     |                      |                       |                       |
| Display                                  | LED  |                     | LCD                  |                       |                       |
| Communications                           | USB  |                     | USB + RS232          |                       |                       |
| Output sockets                           | 4x IEC 320 C13 (10 A)  |                     |                      | 6x IEC 320 C13 (10 A) |                       |
| Standards                                | European directives: LV 2014/35/EU low voltage Directive EMC 2014/30/EU electromagnetic compatibility Directive Standards: Safety IEC EN 62040-1; EMC IEC EN 62040-2; RoHS compliant |                     |                      |                       |                       |
| Certificates                             | CE   |                     |                      |                       |                       |
| Colour                                   | RAL 9005   |                     |                      |                       |                       |
| Ambient temperature for the UPS          | 0 °C - +40 °C  |                     |                      |                       |                       |
| Recommended temperature for battery life | +20 °C - +25 °C  |                     |                      |                       |                       |
| Range of relative humidity               | 5-95% non-condensing   |                     |                      |                       |                       |
| Standard equipment                       | 2 cables for powering loads; user manual   |                     |                      |                       |                       |



# Vision

1:1 800-2000 VA



LINE INTERACTIVE



Tower



GS Nemko certified



Hot swap battery



Plug & Play installation



USB plug



## HIGHLIGHTS

- **Superior protection**
- **Compact and contemporary design**
- **High availability**
- **Versatility**
- **LCD display**
- **Automatic Voltage Regulation (AVR)**

The Vision range is available in models from 800 VA to 2000 VA with sinusoidal digital technology.

The Vision range, with its advanced communications and connectivity options, is the ideal solution for installations requiring superior protection and versatility in the power supply system. Vision provides proven protection of peripheral network devices, servers and network back-up systems.

### SUPERIOR PROTECTION

The Vision range uses LINE INTERACTIVE technology and provides a sinusoidal output. This technology provides efficiency levels of 98% and therefore reduced energy consumption. It also ensures a high level of protection against

mains power disturbances.

The automatic voltage regulator (AVR) provides protection from surges, overvoltages and undervoltages, without battery intervention. Reduced battery usage ensures that the battery set is 100% available for mains power supply failures and is able to provide greater autonomy. EMI filters then provide further protection from voltage surges and transients. When the mains power supply fails, the load is powered by the inverter and receives a perfectly sinusoidal supply for maximum power continuity and reliability. With energy savings in mind, the Vision range features a shut-off button to reduce energy consumption to zero during periods of prolonged inactivity.



### HIGH AVAILABILITY

An EnergyShare socket allows load-shedding and the shutdown of less sensitive peripheral devices to extend battery runtime for critical loads. "Hot Swap" batteries can be removed via the front panel for easy and safe UPS maintenance. Battery test facility to detect deteriorating battery performance. Deep discharge protection to reduce battery ageing.

### VERSATILITY

Cold Start function to allow the UPS to power up with no mains power supply present.

### LCD DISPLAY

Vision models have a backlit LCD display providing UPS status information, load and battery performance.

### ADVANCED COMMUNICATIONS

- Advanced multi-platform communications for all operating systems and network environments: PowerShield<sup>3</sup> monitoring and shutdown software for Windows operating systems 11, 10, 8, Server 2022, 2019, 2016 and previous versions, Windows Server Virtualization Hyper-V, macOS, Linux, Citrix XenServer and other Unix operating systems;
- USB or RS232 serial port interface (selectable);
- Expansion slot for interface boards;
- Status, measurements, alarms and input, output and battery parameters available on LCD display.

### FEATURES

- EnergyShare socket;
- Ability to switch on the UPS in the absence of mains power (Cold Start);
- Batteries are user replaceable without switching off equipment and without interruption to the load (Hot Swap);
- Maximum reliability and protection of PCs thanks to PowerShield<sup>3</sup> monitoring and shutdown software, which can be downloaded free at [www.riello-ups.com](http://www.riello-ups.com);
- Fully configurable using UPS Tools configuration software;
- Highly reliable batteries (automatic and manually-activated battery test);
- Built-in short circuit protection;
- Auto restart (when mains power is restored, after discharge of the batteries)
- GS/Nemko safety seal.

### 2-YEAR WARRANTY



### OPTIONS

#### SOFTWARE

PowerShield<sup>3</sup>  
PowerNetGuard

#### ACCESSORIES

NETMAN 208  
MULTICOM 302

MULTICOM 352

MULTICOM 372

MULTICOM 384

MULTICOM 411

MULTICOM 421

MULTI I/O

MULTIPANEL

### DETAILS

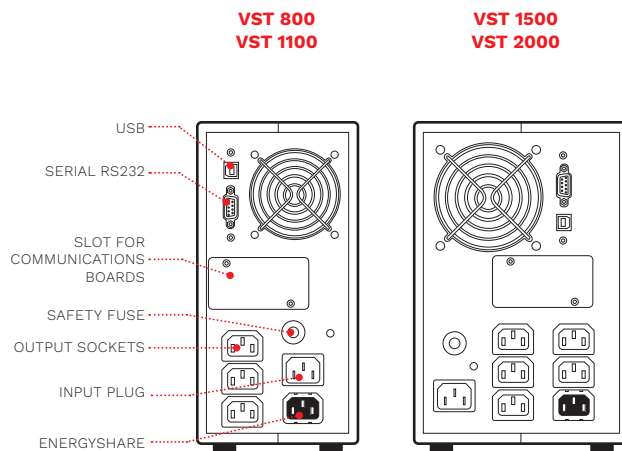

| MODELS                                   | VST 800   | VST 1100             | VST 1500              | VST 2000              |
|--|---|----------------------|-----------------------|-----------------------|
| <b>POWER</b>                             | <b>800 VA/640 W</b>   | <b>1100 VA/880 W</b> | <b>1500 VA/1200 W</b> | <b>2000 VA/1600 W</b> |
| <b>INPUT</b>                             |   |                      |                       |                       |
| Rated voltage [V]                        | 220 / 230 / 240   |                      |                       |                       |
| Voltage tolerance [V]                    | 162 - 290   |                      |                       |                       |
| Rated frequency [Hz]                     | 50 / 60 with automatic selection  |                      |                       |                       |
| Frequency tolerance                      | ±5%   |                      |                       |                       |
| <b>OUTPUT</b>                            |   |                      |                       |                       |
| Rated voltage [V]                        | 220 / 230 / 240 selectable  |                      |                       |                       |
| Frequency [Hz]                           | 50 or 60 with automatic selection   |                      |                       |                       |
| Waveform                                 | Sinusoidal  |                      |                       |                       |
| <b>BATTERIES</b>                         |   |                      |                       |                       |
| Type                                     | VRLA AGM maintenance-free lead based  |                      |                       |                       |
| Recharge time                            | 4-6 h   |                      |                       |                       |
| <b>OVERALL SPECIFICATIONS</b>            |   |                      |                       |                       |
| Net weight [kg]                          | 10.5  | 11.3                 | 16.5                  | 18.5                  |
| Gross weight [kg]                        | 12.2  | 13                   | 18.4                  | 20.4                  |
| Dimensions (WxDxH) [mm]                  | 120x443x247   |                      | 160x443x247           |                       |
| Packaging dimensions (WxDxH) [mm]        | 208x530x342   |                      | 250x540x354           |                       |
| Protections                              | Overload - short circuit - overvoltage - undervoltage - temperature - excessive low battery   |                      |                       |                       |
| Communications                           | USB / RS232 / slot for communications interface   |                      |                       |                       |
| Input plugs                              | 1x IEC 320 C14 (10 A)   |                      |                       |                       |
| Output sockets                           | 4x IEC 320 C13 (10 A)   |                      | 6x IEC 320 C13 (10 A) |                       |
| Standards                                | European directives: LV 2014/35/EU low voltage Directive EMC 2014/30/EU electromagnetic compatibility<br>Directive Standards: Safety IEC EN 62040-1; EMC IEC EN 62040-2; RoHS compliant |                      |                       |                       |
| Colour                                   | RAL 9005  |                      |                       |                       |
| Ambient temperature for the UPS          | 0 °C - +40 °C   |                      |                       |                       |
| Recommended temperature for battery life | +20 °C - +25 °C   |                      |                       |                       |
| Range of relative humidity               | 5-95% non-condensing  |                      |                       |                       |
| Noise [dBA]                              | <40   |                      |                       |                       |



# Vision Rack

1:1 800-1100 VA



Rack



Energy Share



Hot swap battery



Plug & Play installation



USB plug



## HIGHLIGHTS

- **Superior protection**
- **High availability**
- **Versatility**
- **LCD display**
- **Automatic voltage regulation (AVR)**

The Vision Rack range is available in models from 800 VA to 1100 VA with sinusoidal digital technology. The Vision Rack range, with its advanced communications and connectivity options, is the ideal solution for installations requiring superior protection and versatility in the power supply system. Vision Rack provides proven protection of peripheral network devices, servers and network back-up systems.

### SUPERIOR PROTECTION

The Vision Rack range uses LINE INTERACTIVE technology and provides a sinusoidal output voltage. This technology provides efficiency levels of 98% and therefore reduced energy consumption. It also ensures a high level of protection

against mains power disturbances. The automatic voltage regulator (AVR) provides protection from surges, overvoltages and undervoltages, without battery intervention. Reduced battery usage ensures that the battery set is 100% available for mains power supply failures and is able to provide greater autonomy. EMI filters then provide further protection from voltage surges and transients. When the mains power supply fails, the load is powered by the inverter and receives a perfectly sinusoidal supply for maximum power continuity and reliability.

### HIGH AVAILABILITY

An EnergyShare socket allows load-shedding and the shutdown of less



sensitive peripheral devices to extend battery runtime for critical loads. “Hot Swap” batteries can be removed via the front panel for easy and safe UPS maintenance. Battery test facility to detect deteriorating battery performance. Deep discharge protection to reduce battery ageing.

**VERSATILITY**

Cold Start function to allow the UPS to power up with no mains power supply present.

**DISPLAY**

Vision models have a backlit LCD display providing UPS status information, load and battery performance.

**ADVANCED COMMUNICATIONS**

- Advanced multi-platform communications for all operating systems and network environments: PowerShield<sup>3</sup> supervision and shutdown software for Windows operating systems 10, 8, 7, Hyper-V, 2019, 2016, 2012 and previous versions, Mac OS X, Linux, VMWare ESXi, Citrix XenServer and other Unix operating systems;
- USB or RS232 serial port interface (selectable);
- Expansion slot for interface boards;
- Status, measurements, alarms and input, output and battery parameters available on LCD display.

**FEATURES**

- EnergyShare socket;
- Ability to switch on the UPS in the absence of mains power (Cold Start);
- Batteries are user replaceable without switching off equipment and without interruption to the load (Hot Swap);
- USB and RS232 interface;
- Slot for communications boards;
- Maximum reliability and protection of PCs thanks to PowerShield<sup>3</sup> monitoring and shutdown software, which can be downloaded free at [www.riello-ups.com](http://www.riello-ups.com);
- Highly reliable batteries (automatic and manually-activated battery test);
- Built-in short circuit protection;
- Auto restart (when mains power is restored, after discharge of the batteries);
- Emergency power off contact (EPO).

**2-YEAR WARRANTY**

**OPTIONS**

| SOFTWARE                 |
|--------------------------|
| PowerShield <sup>3</sup> |
| PowerNetGuard            |
| ACCESSORIES              |
| NETMAN 208               |
| MULTICOM 302             |
| MULTICOM 352             |
| MULTICOM 372             |

|              |
|--------------|
| MULTICOM 384 |
| MULTICOM 411 |
| MULTICOM 421 |
| MULTI I/O    |
| MULTIPANEL   |

| PRODUCT ACCESSORIES                               |
|---|
| Universal rails for installation in rack cabinets |

**DETAILS**

**VSR 800-1100**

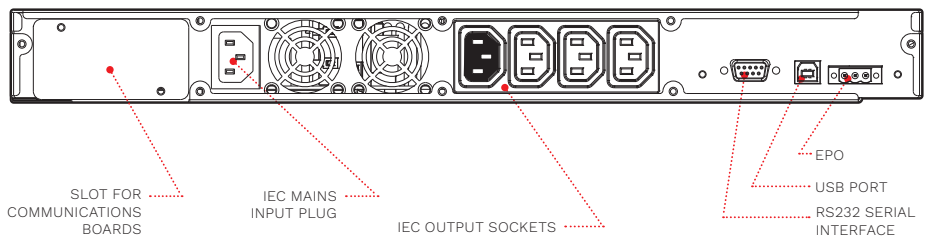

| <b>MODELS</b>                            | <b>VSR 800</b>  | <b>VSR 1100</b>      |
|--|---|----------------------|
| <b>POWER</b>                             | <b>800 VA/640 W</b>   | <b>1100 VA/880 W</b> |
| <b>INPUT</b>                             |   |                      |
| Rated voltage [V]                        | 220 / 230 / 240   |                      |
| Voltage tolerance [V]                    | 162 - 290   |                      |
| Rated frequency [Hz]                     | 50 / 60 with automatic selection  |                      |
| Frequency tolerance                      | ±5% (3% to 10% configurable)  |                      |
| <b>OUTPUT</b>                            |   |                      |
| Rated voltage [V]                        | 230 (220, 240 selectable)   |                      |
| Frequency [Hz]                           | 50 or 60 with automatic selection   |                      |
| Waveform                                 | Sinusoidal  |                      |
| <b>BATTERIES</b>                         |   |                      |
| Type                                     | VRLA AGM maintenance-free lead based  |                      |
| Recharge time                            | 4-6 h   |                      |
| <b>OVERALL SPECIFICATIONS</b>            |   |                      |
| Net weight [kg]                          | 12  | 13                   |
| Gross weight [kg]                        | 14.5  | 15.5                 |
| Dimensions (WxDxH) [mm]                  | 19"x420x1U  |                      |
| Packaging dimensions (WxDxH) [mm]        | 595x540x140   |                      |
| Protections                              | Overload - short circuit - overvoltage - undervoltage - temperature - excessive low battery   |                      |
| Communications                           | USB / RS232 / slot for communications interface   |                      |
| Input plugs                              | 1x IEC 320 C14 (10 A)   |                      |
| Output sockets                           | 4x IEC 320 C13 (10 A)   |                      |
| Standards                                | European directives: LV 2014/35/EU low voltage Directive EMC 2014/30/EU electromagnetic compatibility<br>Directive Standards: Safety IEC EN 62040-1; EMC IEC EN 62040-2; RoHS compliant |                      |
| Ambient temperature for the UPS          | 0 °C - +40 °C   |                      |
| Recommended temperature for battery life | +20 °C - +25 °C   |                      |
| Colour                                   | RAL 9005  |                      |
| Range of relative humidity               | 5-95% non-condensing  |                      |
| Noise [dBA]                              | <50   |                      |



# Vision Dual

1:1 1100-3000 VA

-  VI  
TYPE
- LINE  
INTERACTIVE
-  TowerRack
-  Energy  
Share
-  Hot swap  
battery
-  Plug & Play  
installation
-  USB  
plug



## HIGHLIGHTS

- **Automatic Voltage Regulation (AVR)**
- **Superior protection**
- **High efficiency**
- **High availability**
- **Versatility**
- **Advanced communications**

The Vision Dual range (tower and rack), includes models from 1100 VA to 3000 VA with sinusoidal digital technology. The Vision Dual range, with its advanced communications and connectivity options, is the ideal solution for installations requiring superior protection and versatility in the power supply system. Vision Dual is the ideal solution for the protection of peripheral network devices, conventional or rack servers and network back-up systems. Vision Dual has a practical, modern design and includes several performance advantages over traditional ON LINE UPS. All developed by the Riello UPS research and development team. The UPS provides efficiency levels of

98% and therefore reduced energy consumption. It has an output power factor of 0.9.

### SUPERIOR PROTECTION

The automatic voltage regulator (AVR) provides protection from surges, overvoltages and undervoltages, without battery intervention. Reduced battery usage ensures that the battery set is 100% available for mains power supply failures and is able to provide greater autonomy. EMI filters then provide further protection from voltage surges and transients. When the mains power supply fails, the load is powered by the inverter and receives a perfectly sinusoidal supply for maximum power continuity and reliability.



### HIGH AVAILABILITY

An EnergyShare socket allows load-shedding and the shutdown of less sensitive peripheral devices to extend battery runtime for critical loads. “Hot Swap” batteries can be removed via the front panel for easy and safe UPS maintenance. For business continuity applications requiring long battery runtimes, battery autonomy can be extended up to several hours using ER models (versions 2200 and 3000) fitted with more powerful battery chargers. Battery test facility to detect deteriorating battery performance. Deep discharge protection to reduce battery ageing.

### VERSATILITY

Vision Dual can be installed as a tower or in 19” rack cabinets. The display panel can be easily removed and rotated to suit the type of installation required. Vision Dual is equipped with an emergency power off (EPO) contact that allows for remote shutdown in emergency situations. Cold Start function to allow the UPS to power up with no mains power supply present. Vision Dual models have a backlit LCD display providing UPS status information, load and battery performance.

### ADVANCED COMMUNICATIONS

- Advanced multi-platform communications for all operating systems and network environments: PowerShield<sup>3</sup> supervision and shutdown software for Windows operating systems 10, 8, 7, Hyper-V, 2019, 2016, 2012 and previous versions, Mac OS X, Linux, VMWare ESXi, Citrix XenServer and other Unix operating systems;
- USB or RS232 serial port interface (selectable);
- Expansion slot for SNMP agent interface boards;
- Status, measurements, alarms and input, output and battery parameters available on LCD display.

### 2-YEAR WARRANTY



## OPTIONS

### SOFTWARE

PowerShield<sup>3</sup>  
PowerNetGuard

### ACCESSORIES

NETMAN 208  
MULTICOM 302  
MULTICOM 352  
MULTICOM 372  
MULTICOM 384

MULTICOM 411  
MULTICOM 421  
MULTI I/O  
MULTIPANEL

Manual Bypass 16 A  
Manual Bypass 16 A Rack

### PRODUCT ACCESSORIES

Universal rails for installation in rack cabinets

## BATTERY CABINET

### MODELS

**BTC SDH 72V BB A3**  
**BTC SDH 72V BB M1**

Dimensions  
[mm]

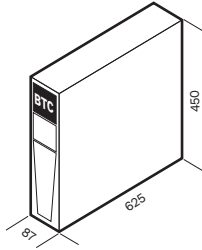

## DETAILS

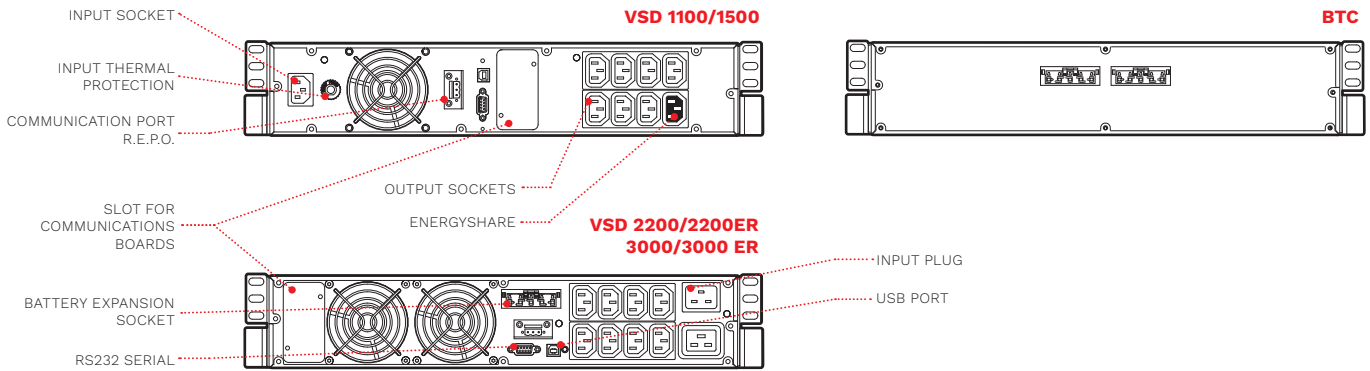

| MODELS   | VSD 1100   | VSD 1500              | VSD 2200              | VSD 2200 ER                                   | VSD 3000              | VSD 3000 ER           |
|--|--|-----------------------|-----------------------|---|-----------------------|-----------------------|
| <b>POWER</b>   | <b>1100 VA/990 W</b>   | <b>1500 VA/1350 W</b> | <b>2200 VA/1980 W</b> | <b>2200 VA/1760 W</b>                         | <b>3000 VA/2700 W</b> | <b>3000 VA/2400 W</b> |
| <b>INPUT</b>   |  |                       |                       |   |                       |                       |
| Rated voltage [V]  | 220 / 230 / 240  |                       |                       |   |                       |                       |
| Voltage range without battery intervention [V]             | 162 <Vin <290  |                       |                       |   |                       |                       |
| Voltage tolerance [V]                                      | 162 - 290  |                       |                       |   |                       |                       |
| Maximum permitted voltage [V]                              | 300  |                       |                       |   |                       |                       |
| Rated frequency [Hz]                                       | 50 or 60 ±5  |                       |                       |   |                       |                       |
| Frequency tolerance [Hz]                                   | 50 ±5% / 60 ±5%  |                       |                       |   |                       |                       |
| Power factor   | >0.98  |                       |                       |   |                       |                       |
| Current distortion   | ≤7%  |                       |                       |   |                       |                       |
| <b>OUTPUT</b>  |  |                       |                       |   |                       |                       |
| Voltage distortion with linear load / with non-linear load | <3% / <8%  |                       |                       |   |                       |                       |
| Frequency [Hz]   | Selectable: 50 or 60 or self-learning  |                       |                       |   |                       |                       |
| Waveform   | Sinusoidal   |                       |                       |   |                       |                       |
| Current crest factor                                       | 2.5 : 1  |                       |                       |   |                       |                       |
| Efficiency ECO and SMART ACTIVE Modes                      | 98.5%  |                       |                       |   |                       |                       |
| Overload Times   | 125% for 10 s, 150% for 1 s  |                       |                       |   |                       |                       |
| <b>BATTERIES</b>   |  |                       |                       |   |                       |                       |
| Type   | VRLA AGM maintenance-free lead based   |                       |                       |   |                       |                       |
| Recharge time  | 2-4 h  |                       |                       |   |                       |                       |
| <b>OVERALL SPECIFICATIONS</b>                              |  |                       |                       |   |                       |                       |
| Net weight [kg]  | 16.5   | 17.5                  | 28                    | 15.5  | 31.5                  | 16.5                  |
| Gross weight [kg]  | 20   | 21                    | 33                    | 20.5  | 36.5                  | 21.5                  |
| Dimensions (WxDxH) [mm]                                    | 87x450x425 (19"x425x2U)  |                       |                       | 87x450x625 (19"x625x2U)                       |                       |                       |
| Packaging dimensions (WxDxH) [mm]                          | 240x500x600  |                       |                       | 240x600x760                                   |                       |                       |
| Protection against overvoltages [J]                        | 300  |                       |                       |   |                       |                       |
| Protections  | Overcurrent - short circuit - overvoltage - undervoltage - temperature - excessive low battery   |                       |                       |   |                       |                       |
| Communications   | USB / DB9 with RS232 and contacts / Slot for communications interface  |                       |                       |   |                       |                       |
| Input plugs  | 1x IEC 320 C14 (10 A)  |                       |                       | 1x IEC 320 C20 (16 A)                         |                       |                       |
| Output sockets   | 8x IEC 320 C13 (10 A)  |                       |                       | 8x IEC 320 C13 (10 A) + 1x IEC 320 C19 (16 A) |                       |                       |
| Standards  | European directives: LV 2014/35/EU low voltage Directive EMC 2014/30/EU electromagnetic compatibility Directive Standards: Safety IEC EN 62040-1; EMC IEC EN 62040-2; RoHS compliant |                       |                       |   |                       |                       |
| Ambient temperature for the UPS                            | 0 °C - +40 °C  |                       |                       |   |                       |                       |
| Recommended temperature for battery life                   | +20 °C - +25 °C  |                       |                       |   |                       |                       |
| Range of relative humidity                                 | 5-95% non-condensing   |                       |                       |   |                       |                       |
| Colour   | RAL 9005   |                       |                       |   |                       |                       |
| Noise level at 1 m (ECO Mode) [dBA]                        | <40  |                       |                       |   |                       |                       |
| Standard equipment provided                                | Power cable, serial cable, USB cable, safety manual, quick start guide, user manual on CD-ROM  |                       |                       |   |                       |                       |

# Sentinel Rack



1:1 1500-3000 VA



ONLINE



Rack



Plug & Play  
installation



USB  
plug



## HIGHLIGHTS

- **Power factor 0.9**
- **Operating flexibility**
- **Emergency function**
- **Battery optimisation**
- **Runtime expandability**
- **Compact design**
- **Rack depth of 380 mm**

Sentinel Rack has compact design and improved performance developed by the Riello UPS research and development team. Sentinel Rack uses ON LINE double conversion technology, resulting in the highest levels of reliability and maximum protection for critical loads such as servers and IT and voice/data applications. For business continuity applications requiring long battery runtimes, battery autonomy can be extended up to several hours using the 3000 VA model fitted with more powerful battery charger. The front display panel has been entirely redesigned, adding an LCD display that shows the input and output voltages, battery readings and UPS operating status information. The inverter and the microprocessor control stage

provide increased efficiency and greater configuration options. Maximum expandability: the Sentinel Rack is supplied as standard with a USB port and an expansion slot for protocol conversion or relay contacts boards. With energy savings in mind, Sentinel Rack is also fitted with a shut-off switch to reduce energy consumption to zero during prolonged periods of inactivity (ECO LINE). Sentinel Rack is available in 1500 VA and 3000 VA models.

### OPERATING FLEXIBILITY

Different operating modes are available to reduce energy consumption based on specific load and user requirements.

- ON LINE: maximum load protection and output voltage waveform quality;





- ECO Mode: the UPS uses LINE INTERACTIVE technology, with the load powered by the mains, reducing consumption and thus improving efficiency (up to 98%);
- SMART ACTIVE Mode: the UPS automatically selects ON LINE or LINE INTERACTIVE operation, depending on the quality of the mains supply, checking the number, frequency and type of disturbances present;
- STANDBY OFF: the UPS supplies the load only when the mains fails. The inverter begins working with a progressive start up sequence to prevent inrush currents;
- Frequency Converter operation (50 or 60 Hz).

### EMERGENCY FUNCTION

This configuration ensures the operation of emergency systems that must be supplied in the event of a mains power failure, such as emergency lighting, fire detection/extinguishing systems and alarms. When the mains power supply fails, the inverter begins powering the loads with a progressive start up (Soft Start) in order to prevent overload. Sentinel Rack is compliant for installation in medium-voltage transformer rooms in accordance with applicable legislation, for the power supply with reserve charge of medium-voltage coils.

### BATTERY OPTIMISATION

The Sentinel Rack range has a deep discharge protection device to optimise battery life. Periodically the UPS carries out a battery efficiency test (which can also be manually activated); its wide input voltage tolerance range helps to reduce battery usage and maintain performance over time.



### RUNTIME EXPANDABILITY (SER 3000)

Optional battery extension packs can be connected to increase UPS runtime. SER 3000 ER version is designed without internal batteries and a more powerful battery chargers to achieve longer runtimes.

### LOW NOISE LEVEL

Thanks to the use of high frequency components and load-based fan speed control, the noise produced by the UPS is less than 40 dBA.

### FEATURES

- Filtered, stabilised and reliable voltage: double conversion ON LINE technology (VFI compliant with IEC 62040-3) with filters for the suppression of atmospheric disturbances;
- High overload capability (up to 150%);
- Programmable Auto-restart when mains is restored;
- Battery start up (Cold Start);
- Power factor correction (UPS input power factor, close to 1);
- Wide input voltage tolerance range (from 140 V to 276 V) without battery intervention.
- Runtime extendable up to several hours;
- Fully configurable using UPS Tools configuration software;
- Highly reliable batteries (automatic and manually-activated battery test);
- High level of UPS reliability (total microprocessor control);
- Low impact on the mains (sinusoidal take up).

### ADVANCED COMMUNICATIONS

- Multi-platform communication for all operating systems and network environments: PowerShield<sup>3</sup> supervision and shutdown software for Windows operating systems 11, 10, 8, Server 2022, 2019, 2016 and previous versions, Windows Server Virtualization Hyper-V, macOS, Linux, Citrix XenServer and other Unix operating systems;
- UPS Tools configuration and customisation software supplied as standard;
- RS232 serial port and opto-isolated contacts;
- USB port;
- Slot for communications boards.

### 2-YEAR WARRANTY

## OPTIONS

| SOFTWARE                 |
|--------------------------|
| PowerShield <sup>3</sup> |
| PowerNetGuard            |
| ACCESSORIES              |
| NETMAN 208               |
| MULTICOM 302             |

|                         |
|-------------------------|
| MULTICOM 352            |
| MULTICOM 372            |
| MULTICOM 384            |
| MULTI I/O               |
| MULTIPANEL              |
| Manual Bypass 16 A Rack |

## BATTERY CABINET

| MODELS | BTC SER 72V BB A5 |
|--------|-------------------|
|--------|-------------------|

Dimensions  
[mm]

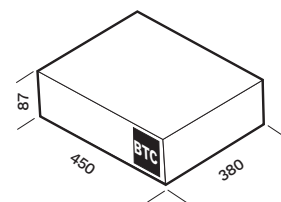

## DETAILS

### SER 1500

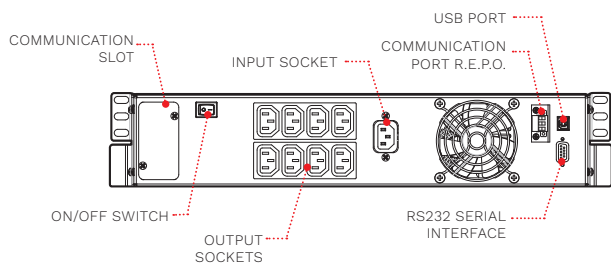

### SER 3000

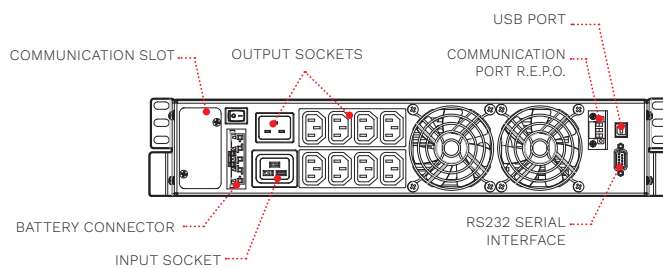

### BTC

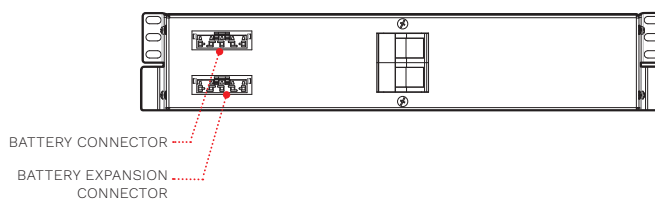

| <b>MODELS</b>  | <b>SER 1500</b>   | <b>SER 3000 ER</b>                            |
|--|---|---|
| <b>POWER</b>   | <b>1500 VA/1350 W</b>   | <b>3000 VA/2700 W</b>                         |
| <b>INPUT</b>   |   |   |
| Rated voltage [V]  | 220 / 230 / 240   |   |
| Voltage range without battery intervention [V]             | 140 <Vin <276 @ 50% load / 184 <Vin <276 @ 100% load  |   |
| Voltage tolerance [V]                                      | 230 ±20%  |   |
| Maximum permitted voltage [V]                              | 300   |   |
| Rated frequency [Hz]                                       | 50 / 60   |   |
| Frequency tolerance [Hz]                                   | 50 ±5% / 60 ±5%   |   |
| Power factor   | >0.99   |   |
| Current distortion   | ≤7%   |   |
| <b>BYPASS</b>  |   |   |
| Voltage tolerance [V]                                      | 180 / 264   |   |
| Frequency tolerance [Hz]                                   | Frequency selected (from ±1.5 to ±5 configurable)   |   |
| Overload times   | 125% for 5 s, 150% for 1 s  |   |
| <b>OUTPUT</b>  |   |   |
| Voltage distortion with linear load / with non-linear load | <2% / <4%   |   |
| Frequency [Hz]   | Selectable: 50 or 60 or self-learning   |   |
| Static variation   | ±1%   |   |
| Dynamic variation  | ≤5% in 20 ms  |   |
| Waveform   | Sinusoidal  |   |
| Current crest factor                                       | 3:1   |   |
| Efficiency ECO and SMART ACTIVE Modes                      | 98%   |   |
| <b>BATTERIES</b>   |   |   |
| Type   | VRLA AGM maintenance-free lead based  |   |
| Recharge time  | 2-4 h   |   |
| <b>OVERALL SPECIFICATIONS</b>                              |   |   |
| Net weight [kg]  | 22  | 14 (without batteries)                        |
| Gross weight [kg]  | 24  | 18  |
| Dimensions (WxDxH) [mm]                                    | 450x380x87 (19"x380x2U)   |   |
| Packaging dimensions (WxDxH) [mm]                          | 540x490x190   |   |
| Protection against overvoltage [J]                         | 300   |   |
| Protections  | Overcurrent - short circuit - overvoltage - undervoltage - temperature - excessive low battery  |   |
| Communications   | USB / DB9 with RS232 and contacts / Slot for communications interface   |   |
| Input plugs  | 1x IEC 320 C14 (10 A)   | 1x IEC 320 C20 (16 A)                         |
| Output sockets   | 8x IEC 320 C13 (10 A)   | 8x IEC 320 C13 (10 A) + 1x IEC 320 C19 (16 A) |
| Standards  | European directives: LV 2014/35/EU low voltage Directive EMC 2014/30/EU electromagnetic compatibility Directive Standards: Safety IEC EN 62040-1; EMC IEC EN 62040-2; RoHS compliant Classification in accordance with IEC 62040-3 (Voltage Frequency Independent) VFI - SS - 111 |   |
| Ambient temperature for the UPS                            | 0 °C - +40 °C   |   |
| Recommended temperature for battery life                   | +20 °C - +25 °C   |   |
| Range of relative humidity                                 | 5-95% non-condensing  |   |
| Colour   | RAL 9005  |   |
| Noise level at 1 m (ECO Mode) [dBA]                        | <40   |   |
| Standard equipment provided                                | Power cable, IEC-IEC cable, USB cable, safety manual, quick start guide   |   |

# Sentinel Pro



1:1 700-3000 VA



ONLINE



Tower



GS Nemko certified



Plug & Play installation



Supercaps UPS



USB plug



## HIGHLIGHTS

- **Power factor 0.9**
- **Operating flexibility**
- **Emergency function**
- **Battery optimisation**
- **Runtime expandability**
- **Low noise level**

Sentinel Pro has a unique, modern design and improved performance created by the Riello UPS research and development team. Sentinel Pro uses ON LINE double conversion technology, resulting in the highest levels of reliability and maximum protection for critical loads such as servers and IT and voice/data applications. For business continuity applications requiring long battery runtimes, battery autonomy can be extended up to several hours using ER models fitted with more powerful battery chargers. The front display panel has been entirely redesigned, adding an LCD display that shows the input and output voltages, battery readings and UPS operating status information. The inverter and the microprocessor control stage

has been completely redesigned to provide increased efficiency and greater configuration options. Maximum expandability: the Sentinel Pro is supplied as standard with a USB port and an expansion slot for protocol conversion or relay contacts boards. With energy savings in mind, Sentinel Pro is also fitted with a shut-off button to reduce energy consumption to zero during prolonged periods of inactivity (ECO LINE). Sentinel Pro is available in 700 VA, 1000 VA, 1500 VA, 2200 VA and 3000 VA models.

### OPERATING FLEXIBILITY

Different operating modes are available to reduce energy consumption based on specific load and user requirements.

- ON LINE: maximum load protection and



output voltage waveform quality;

- ECO Mode: the UPS uses LINE INTERACTIVE technology, with the load powered by the mains, reducing consumption and thus improving efficiency (up to 98%);
- SMART ACTIVE Mode: the UPS automatically selects ON LINE or LINE INTERACTIVE operation, depending on the quality of the mains supply, checking the number, frequency and type of disturbances present;
- STANDBY OFF: the UPS supplies the load only when the mains fails. The inverter begins working with a progressive start up sequence to prevent inrush currents.
- Frequency converter operation (50 or 60 Hz).

#### EMERGENCY FUNCTION

This configuration ensures the operation of emergency systems that must be supplied in the event of a mains power failure, such as emergency lighting, fire detection/extinguishing systems and alarms. When the mains power supply fails, the inverter begins powering the loads with a progressive start up (Soft Start) in order to prevent overload. Sentinel Pro is compliant for installation in medium-voltage transformer rooms in accordance with applicable legislation, for the power supply with reserve charge of medium-voltage coils.

#### BATTERY OPTIMISATION

The Sentinel Pro range has a deep discharge protection device to optimise battery life. Periodically the UPS carries out a battery efficiency test (which can also be manually activated); its wide input voltage tolerance range helps to reduce battery usage and maintain performance over time.

#### RUNTIME EXPANDABILITY

Optional battery extension packs can be connected to increase UPS runtime. In addition the Sentinel Pro range includes ER versions with no internal batteries and more powerful battery chargers for longer runtimes.

#### LOW NOISE LEVEL

Thanks to the use of high frequency components and load-based fan speed control, the noise produced by the UPS is less than 40 dBA.

#### FEATURES

- Filtered, stabilised and reliable voltage: double conversion ON LINE technology (VFI compliant with IEC 62040-3) with filters for the suppression of atmospheric disturbances;
- High overload capability (up to 150%)
- Programmable Auto-restart when mains is restored;
- Battery start up (Cold Start);
- Power factor correction (UPS input power factor, close to 1);
- Wide input voltage tolerance range (from 140 V to 276 V) without battery intervention;
- Runtime extendable up to several hours;
- Fully configurable using UPS Tools configuration software;
- Highly reliable batteries (automatic and manually-activated battery test);
- High level of UPS reliability (total microprocessor control);
- Low impact on the mains (sinusoidal take up).

#### ADVANCED COMMUNICATIONS

- Multi-platform communication for all operating systems and network environments: PowerShield<sup>3</sup> supervision and shutdown software for Windows operating systems 11, 10, 8, Server 2022, 2019, 2016 and previous versions, Windows Server Virtualization Hyper-V, macOS, Linux, Citrix XenServer and other Unix operating systems;
- UPS Tools configuration and customisation software supplied as standard;
- RS232 serial port and opto-isolated contacts;
- USB port;
- Slot for communications boards.

#### 2-YEAR WARRANTY



## OPTIONS

### SOFTWARE

PowerShield<sup>3</sup>  
PowerNetGuard

### ACCESSORIES

NETMAN 208  
MULTICOM 302  
MULTICOM 352

MULTICOM 372

MULTICOM 384

MULTICOM 411

MULTICOM 421

MULTI I/O

MULTIPANEL

Manual Bypass 16 A

## BATTERY CABINET

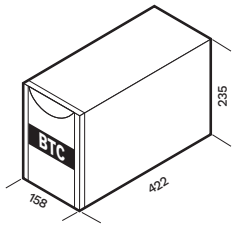
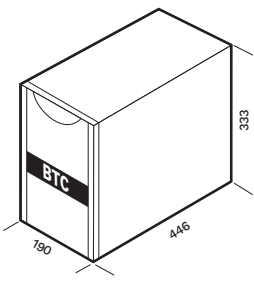
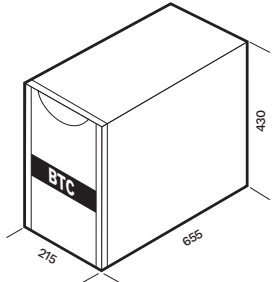
| MODELS          | BTC SEP 36V BB A3<br>BTC SEP 36V BB M1  | BTC SEP 72V BB A3<br>BTC SEP 72V BB M1  | BTC SEP 36V BB B1<br>BTC SEP 72V BB B1   |
|-----------------|---|---|--|
| Dimensions [mm] |  |  |  |

## DETAILS

SEP 700  
SEP 1500

SEP 1000  
SEP 1000 ER

SEP 2200  
SEP 2200 ER

SEP 3000  
SEP 3000 ER

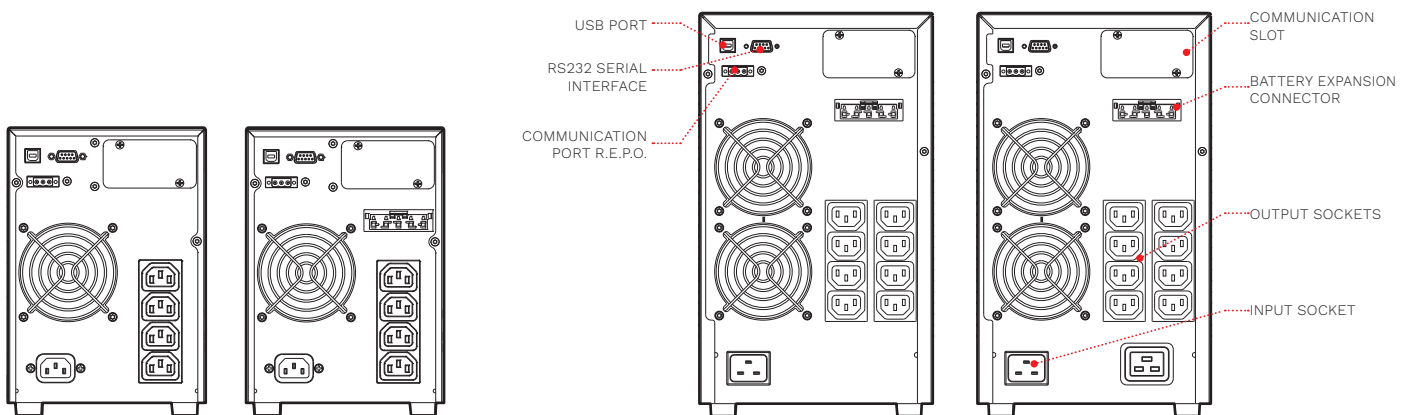

| MODELS   | SEP 700  | SEP 1000             | SEP 1000 ER | SEP 1500              | SEP 2200              | SEP 2200 ER | SEP 3000   | SEP 3000 ER |
|--|--|----------------------|-------------|-----------------------|-----------------------|-------------|--|-------------|
| <b>POWER</b>   | <b>700 VA/630 W</b>  | <b>1000 VA/900 W</b> |             | <b>1500 VA/1350 W</b> | <b>2200 VA/1980 W</b> |             | <b>3000 VA/2700 W</b>                            |             |
| <b>INPUT</b>   |  |                      |             |                       |                       |             |  |             |
| Rated voltage [V]  | 220 / 230 / 240  |                      |             |                       |                       |             |  |             |
| Voltage range without battery intervention [V]             | 140 <Vin <276 @ 50% load / 184 <Vin <276 @ 100% load   |                      |             |                       |                       |             |  |             |
| Voltage tolerance [V]                                      | 230 ±20%   |                      |             |                       |                       |             |  |             |
| Maximum permitted voltage [V]                              | 300  |                      |             |                       |                       |             |  |             |
| Rated frequency [Hz]                                       | 50 / 60  |                      |             |                       |                       |             |  |             |
| Frequency tolerance [Hz]                                   | 50 ±5% / 60 ±5%  |                      |             |                       |                       |             |  |             |
| Power factor   | >0.99  |                      |             |                       |                       |             |  |             |
| Current distortion   | ≤7%  |                      |             |                       |                       |             |  |             |
| <b>BYPASS</b>  |  |                      |             |                       |                       |             |  |             |
| Voltage tolerance [V]                                      | 180 / 264  |                      |             |                       |                       |             |  |             |
| Frequency tolerance [Hz]                                   | Frequency selected (from ±1.5 to ±5 configurable)  |                      |             |                       |                       |             |  |             |
| Overload times   | 125% for 5 s, 150% for 1 s   |                      |             |                       |                       |             |  |             |
| <b>OUTPUT</b>  |  |                      |             |                       |                       |             |  |             |
| Voltage distortion with linear load / with non-linear load | <2% / <4%  |                      |             |                       |                       |             |  |             |
| Frequency [Hz]   | Selectable: 50 or 60 or self-learning  |                      |             |                       |                       |             |  |             |
| Static variation   | ±1%  |                      |             |                       |                       |             |  |             |
| Dynamic variation  | ≤5% in 20 ms   |                      |             |                       |                       |             |  |             |
| Waveform   | Sinusoidal   |                      |             |                       |                       |             |  |             |
| Current crest factor                                       | 3:1  |                      |             |                       |                       |             |  |             |
| Efficiency ECO and SMART ACTIVE Modes                      | 98%  |                      |             |                       |                       |             |  |             |
| <b>BATTERIES</b>   |  |                      |             |                       |                       |             |  |             |
| Type   | VRLA AGM maintenance-free lead based; Supercaps  |                      |             |                       |                       |             |  |             |
| Recharge time  | 2-4 h  | N.A.                 |             | 2-4 h                 | N.A.                  |             | 2-4 h  | N.A.        |
| <b>OVERALL SPECIFICATIONS</b>                              |  |                      |             |                       |                       |             |  |             |
| Net weight [kg]  | 10.9   | 13.3                 | 7           | 14.8                  | 25.6                  | 14          | 28   | 15          |
| Gross weight [kg]  | 12.5   | 14.9                 | 8.6         | 15.5                  | 28.8                  | 17          | 31.2   | 18          |
| Dimensions (WxDxH) [mm]                                    | 158x422x235  |                      |             |                       | 190x446x333           |             |  |             |
| Packaging dimensions (WxDxH) [mm]                          | 245x500x340  |                      |             |                       | 325x585x470           |             |  |             |
| Protection against overvoltage [J]                         | 300  |                      |             |                       |                       |             |  |             |
| Protections  | Overcurrent - short circuit - overvoltage - undervoltage - temperature - excessive low battery   |                      |             |                       |                       |             |  |             |
| Communications   | USB / DB9 with RS232 and contacts / Slot for communications interface  |                      |             |                       |                       |             |  |             |
| Input plugs  | 1x IEC 320 C14 (10 A)  |                      |             |                       | 1x IEC 320 C20 (16 A) |             |  |             |
| Output sockets   | 4x IEC 320 C13 (10 A)  |                      |             |                       | 8x IEC 320 C13 (10 A) |             | 8x IEC 320 C13 (10 A)<br>+ 1x IEC 320 C19 (16 A) |             |
| Standards  | European directives: LV 2014/35/EU low voltage Directive EMC 2014/30/EU electromagnetic compatibility<br>Directive Standards: Safety IEC EN 62040-1; EMC IEC EN 62040-2; RoHS compliant<br>Classification in accordance with IEC 62040-3 (Voltage Frequency Independent) VFI - SS - 111<br>UL 1778:2014 and CSA C22.2 No. 107.3-14 |                      |             |                       |                       |             |  |             |
| Ambient temperature for the UPS                            | 0 °C - +40 °C  |                      |             |                       |                       |             |  |             |
| Recommended temperature for battery life                   | +20 °C - +25 °C  |                      |             |                       |                       |             |  |             |
| Range of relative humidity                                 | 5-95% non-condensing   |                      |             |                       |                       |             |  |             |
| Colour   | RAL 9005   |                      |             |                       |                       |             |  |             |
| Noise level at 1 m (ECO Mode) [dBA]                        | <40  |                      |             |                       |                       |             |  |             |
| Standard equipment provided                                | Power cable, IEC-IEC cable, USB cable, safety manual, quick start guide  |                      |             |                       |                       |             |  |             |

# Sentinel Dual SDH

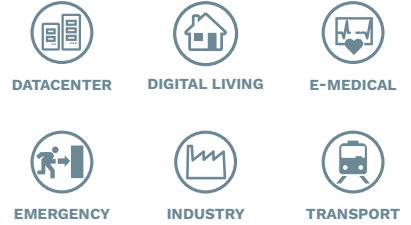

1:1 1-3 kVA



ONLINE



Tower Rack



Energy Share



Hot swap battery



Plug & Play installation



USB plug

## HIGHLIGHTS

- **Power factor 0.9**
- **Simplified installation**
- **Installation versatility**
- **Reduced running costs**
- **Runtime expandability**
- **Low noise level**

Sentinel Dual is the new range of high density double conversion ON LINE UPS suitable for powering a wide range of devices such as servers, storage systems, VoIP telephony equipment, network and medical systems as well as industrial applications.

It is also ideal for powering and protecting Blade Server systems with high input power factor. At only 2U, Sentinel Dual is ideal for 19" rack cabinet installations. Sentinel Dual has a practical, modern design and includes several performance advantages over traditional ON LINE UPS. All developed by the Riello UPS research and development team. The newly-designed inverter is one of the best energy conversion systems on the market, with a 0.9 output power factor and high

efficiency in ON LINE Mode. For business continuity applications requiring long battery runtimes, battery autonomy can be extended up to several hours using ER models fitted with more powerful battery chargers. With energy savings in mind, Sentinel Dual is also fitted with a shut-off button to reduce energy consumption to zero during prolonged periods of inactivity.

### SIMPLIFIED INSTALLATION

- Sentinel Dual can be installed as a tower or in 19" rack cabinets, by simply pulling out and rotating the display panel;
- Low noise (<40 dBA): can be installed in any environment thanks to its high frequency switching inverter and PWM load-dependent digitally controlled fan;
- Operation guaranteed up to 40 °C (the





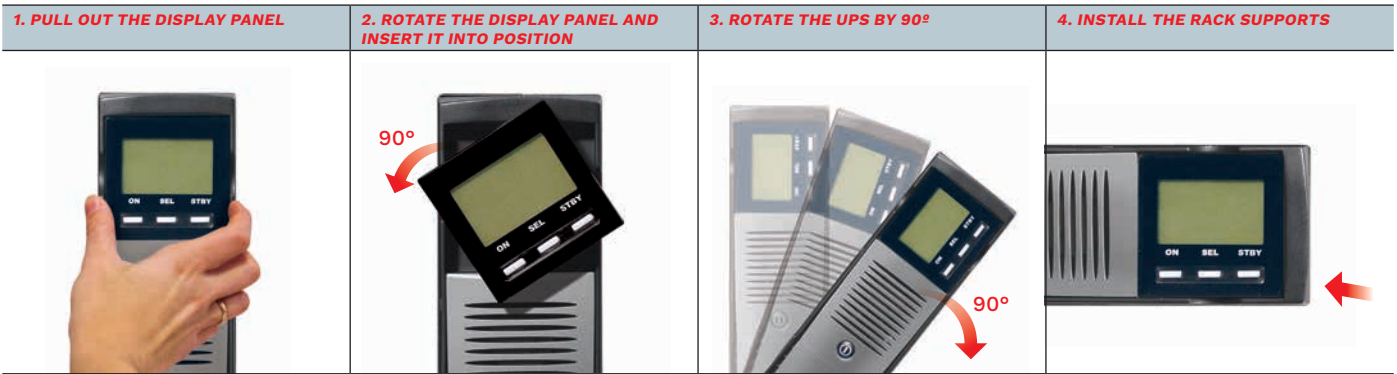

components are designed for high temperatures and are thus subject to less stress at normal temperatures);

- On Sentinel Dual models, the output sockets can be programmed to disconnect less critical loads during blackouts (EnergyShare function).

#### INSTALLATION VERSATILITY

Sentinel Dual can be used in a tower or rack format, by simply turning the display and adding the supplied handles or optional runners.

#### REDUCED RUNNING COSTS

The UPS is highly flexible and easy to configure. Programmable functions can be set via software or manually via the front display panel. Sentinel Dual can be configured in the following operating modes:

- ON LINE: maximum load protection and output voltage waveform quality;
- ECO Mode: to increase efficiency (up to to 98%); allows you to select LINE INTERACTIVE technology;
- SMART ACTIVE: the UPS automatically decides the operating mode based on the mains power quality;
- STANDBY OFF: the UPS can be selected to function only when the mains power supply fails (emergency only mode);
- Frequency Converter: operation (50 or 60 Hz).

#### ADVANCED COMMUNICATIONS

Sentinel Dual offers maximum flexibility for integration with all types of communication systems.

- Multi-platform communication for all operating systems and network environments: PowerShield<sup>3</sup> supervision and shutdown software for Windows operating systems 11, 10, 8, Server 2022, 2019, 2016 and previous versions, Windows Server Virtualization Hyper-V, macOS, Linux, Citrix XenServer and other Unix operating systems;
- UPS Tools configuration and

customisation software supplied as standard;

- RS232 serial port and opto-isolated contacts;
- USB port;
- Slot for communications boards such as Modbus/Jbus, TCP/IP-SNMP and relay contacts.

#### EMERGENCY FUNCTION

This configuration ensures the operation of emergency systems that must be supplied in the event of a mains power failure, such as emergency lighting, fire detection/extinguishing systems and alarms.

When the mains power supply fails, the inverter begins powering the loads with a progressive start up (Soft Start) in order to prevent overload.

Sentinel Dual is compliant for installation in medium-voltage transformer rooms in accordance with applicable legislation, for the power supply with reserve charge of medium-voltage coils.

#### HIGH QUALITY OUTPUT VOLTAGE

- Even with non-linear loads (IT loads with a crest factor of up to 3:1);
- High short circuit current on bypass;
- High overload capacity: 150% by inverter (even with mains failure);
- Filtered, stabilised and reliable voltage (ON LINE double conversion technology (VFI compliant with EN62040-3) with filters for the suppression of atmospheric disturbances;
- Power factor correction: UPS input power factor close to 1 and sinusoidal current uptake.

#### HIGH BATTERY RELIABILITY

- Automatic and manual battery test;
- Batteries are user replaceable without switching off equipment and without interruption to the load (Hot Swap);
- Unlimited extendible runtime using matching battery cabinets.

#### LOW NOISE LEVEL

Thanks to the use of high frequency components and load-based fan speed control, the noise produced by the UPS is less than 40 dBA.

#### OTHER FEATURES

- Output voltage can be selected via software (220/230/240 V);
- Auto-restart when mains power is restored (programmable via software);
- STANDBY ON bypass: when the machine is switched off, it automatically goes into bypass and battery charge mode;
- Minimum load switch-off;
- Battery discharge warning;
- Start up delay;
- Total microprocessor control;
- Automatic bypass without interruption;
- Status, measurements and alarms available on standard backlit display;
- UPS firmware updating via PC;
- Input protection via resettable thermal switch (versions up to 1500 VA);
- Backfeed protection standard: to prevent energy from being fed back to the network;
- Manual switching to bypass.

#### 2-YEAR WARRANTY

## OPTIONS

### SOFTWARE

PowerShield<sup>3</sup>  
PowerNetGuard

### ACCESSORIES

NETMAN 208  
MULTICOM 302  
MULTICOM 352  
MULTICOM 372  
MULTICOM 384  
MULTICOM 411  
MULTICOM 421  
MULTI I/O  
MULTIPANEL  
Manual Bypass 16 A  
Manual Bypass 16 A Rack

### PRODUCT ACCESSORIES

Universal rails for installation in rack cabinets

## BATTERY CABINET

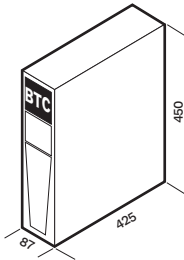
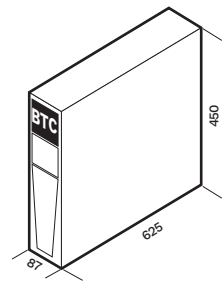
| MODELS          | BTC SDH 36V BB A3<br>BTC SDH 36V BB M1   | BTC SDH 72V BB A3<br>BTC SDH 72V BB M1  |
|-----------------|--|---|
| Dimensions [mm] |  |  |

## DETAILS

### SDH 1000

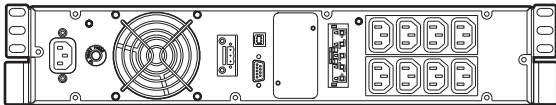

### BTC

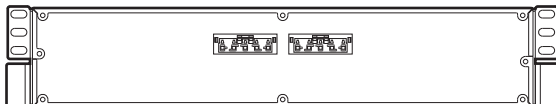

### SDH 1500

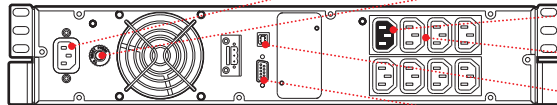

### SDH 2200-2200 ER SDH 3000-3000 ER

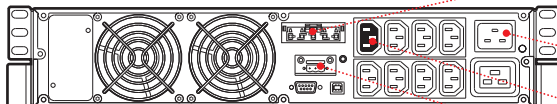

- INPUT SOCKET
- INPUT THERMAL PROTECTION
- ENERGYSHARE
- OUTPUT SOCKETS
- USB PORT
- RS232 SERIAL
- BATTERY EXPANSION SOCKET
- INPUT PLUG
- ENERGYSHARE
- COMMUNICATION PORT R.E.P.O.



| MODELS   | SDH 1000  | SDH 1500              | SDH 2200              | SDH 2200 ER                                   | SDH 3000              | SDH 3000 ER           |
|--|---|-----------------------|-----------------------|---|-----------------------|-----------------------|
| <b>POWER</b>   | <b>1000 VA/900 W</b>  | <b>1500 VA/1350 W</b> | <b>2200 VA/1980 W</b> | <b>2200 VA/1760 W</b>                         | <b>3000 VA/2700 W</b> | <b>3000 VA/2400 W</b> |
| <b>INPUT</b>   |   |                       |                       |   |                       |                       |
| Rated voltage [V]  | 220 / 230 / 240   |                       |                       |   |                       |                       |
| Voltage range without battery intervention [V]             | 140 <Vin <276 @ 50% load / 184 <Vin <276 @ 100% load  |                       |                       |   |                       |                       |
| Voltage tolerance [V]                                      | 230 ±20%  |                       |                       |   |                       |                       |
| Maximum permitted voltage [V]                              | 300   |                       |                       |   |                       |                       |
| Rated frequency [Hz]                                       | 50 / 60 ±5  |                       |                       |   |                       |                       |
| Frequency tolerance [Hz]                                   | 50 ±5% / 60 ±5%   |                       |                       |   |                       |                       |
| Power factor   | >0.98   |                       |                       |   |                       |                       |
| Current distortion   | ≤7%   |                       |                       |   |                       |                       |
| <b>BYPASS</b>  |   |                       |                       |   |                       |                       |
| Voltage tolerance [V]                                      | 200 / 253   |                       |                       |   |                       |                       |
| Frequency tolerance [Hz]                                   | Frequency selected (from ±0.5 to ±5 configurable)   |                       |                       |   |                       |                       |
| Overload Times   | 125% for 4 s, 150% for 0.5 s  |                       |                       |   |                       |                       |
| <b>OUTPUT</b>  |   |                       |                       |   |                       |                       |
| Voltage distortion with linear load / with non-linear load | <2% / ≤3.5%   |                       |                       |   |                       |                       |
| Frequency [Hz]   | Selectable: 50 or 60 or self-learning   |                       |                       |   |                       |                       |
| Static variation   | ±1%   |                       |                       |   |                       |                       |
| Dynamic variation  | ≤5% in 20 ms  |                       |                       |   |                       |                       |
| Waveform   | Sinusoidal  |                       |                       |   |                       |                       |
| Current crest factor                                       | 3:1   |                       |                       |   |                       |                       |
| Efficiency ECO and SMART ACTIVE Modes                      | 98%   |                       |                       |   |                       |                       |
| <b>BATTERIES</b>   |   |                       |                       |   |                       |                       |
| Type   | VRLA AGM maintenance-free lead based  |                       |                       |   |                       |                       |
| Recharge time  | 2-4 h   |                       |                       |   |                       |                       |
| <b>OVERALL SPECIFICATIONS</b>                              |   |                       |                       |   |                       |                       |
| Net weight [kg]  | 17.5  | 18                    | 30.5                  | 15  | 31                    | 15                    |
| Gross weight [kg]  | 21  | 21.5                  | 35                    | 19.5  | 35.5                  | 19.5                  |
| Dimensions (WxDxH) [mm]                                    | (T- 87x425x450) (R- 19"x425x2U)   |                       |                       | (T- 87x625x450) (R- 19"x625x2U)               |                       |                       |
| Packaging dimensions (WxDxH) [mm]                          | 550x600x245   |                       |                       | 600x760x245                                   |                       |                       |
| Protection against overvoltage [J]                         | 300   |                       |                       |   |                       |                       |
| Protections  | Overcurrent - short circuit - overvoltage - undervoltage - temperature - excessive low battery  |                       |                       |   |                       |                       |
| Communications   | USB / DB9 with RS232 and contacts / Slot for communications interface   |                       |                       |   |                       |                       |
| Input plugs  | 1x IEC 320 C14 (10 A)   |                       |                       | 1x IEC 320 C20 (16 A)                         |                       |                       |
| Output sockets   | 8x IEC 320 C13 (10 A)   |                       |                       | 8x IEC 320 C13 (10 A) + 1x IEC 320 C19 (16 A) |                       |                       |
| Standards  | European directives: LV 2014/35/EU low voltage Directive EMC 2014/30/EU electromagnetic compatibility<br>Directive Standards: Safety IEC EN 62040-1; EMC IEC EN 62040-2; RoHS compliant<br>Classification in accordance with IEC 62040-3 (Voltage Frequency Independent) VFI - SS - 111 |                       |                       |   |                       |                       |
| Ambient temperature for the UPS                            | 0 °C - +40 °C   |                       |                       |   |                       |                       |
| Recommended temperature for battery life                   | +20 °C - +25 °C   |                       |                       |   |                       |                       |
| Relative humidity  | 5-95% non-condensing  |                       |                       |   |                       |                       |
| Colour   | RAL 9005  |                       |                       |   |                       |                       |
| Noise level at 1 m (ECO Mode) [dBA]                        | <40   |                       |                       |   |                       |                       |
| Standard equipment provided                                | Power cable, serial cable, USB cable, safety manual, quick start guide  |                       |                       |   |                       |                       |

# Sentinel Dual SDU

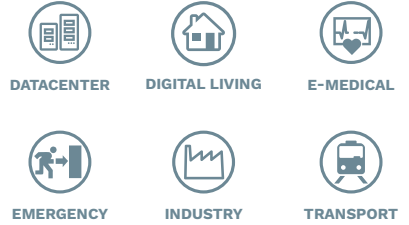

ONLINE



Tower Rack



Energy Share



Hot swap battery



Plug & Play installation



USB plug

**1:1** 4 kVA  
5-10 kVA/kW  
**3:1** 8-10 kVA/kW



## HIGHLIGHTS

- **Power factor 1 kW = kVA\***
- **Parallelable up to 3 units**
- **Simplified Installation**
- **Operating mode selection**
- **High quality output voltage**
- **High battery reliability**

\* SDU 4000 has 3600 W

Sentinel Dual is the best solution for powering mission critical applications and electro-medical devices requiring maximum power reliability. Flexibility of installation and use (digital display, user-replaceable battery set), as well as the many communication options available, makes the Sentinel Dual suitable for many different applications from IT to security. Up to 3 Sentinel Dual can be operated in parallel in either capacity or N+1 redundant configuration offering increased reliability for critical system. The Sentinel Dual can be installed as tower (floor standing) or rack, ideal for network and server rack applications. The Sentinel Dual range is available in 4 kVA and 5-6-8-10 kVA/kW models with ON LINE double conversion technology

(VFI): the load is powered continuously by the inverter which supplies a sinusoidal voltage, filtered and stabilised in terms of voltage, form and frequency. In addition, the input and output filters significantly increase the load's immunity to mains disturbances and lightning strikes. Technology and performance: selectable ECO Mode and SMART ACTIVE Mode functions. Diagnostics: Standard digital display, RS232 and USB interfaces with PowerShield<sup>3</sup> software downloadable, communications slot for connectivity accessories.

### SIMPLIFIED INSTALLATION

- Can be installed on the floor (tower version) or in rack mount cabinets (rack version). The display panel can be rotated



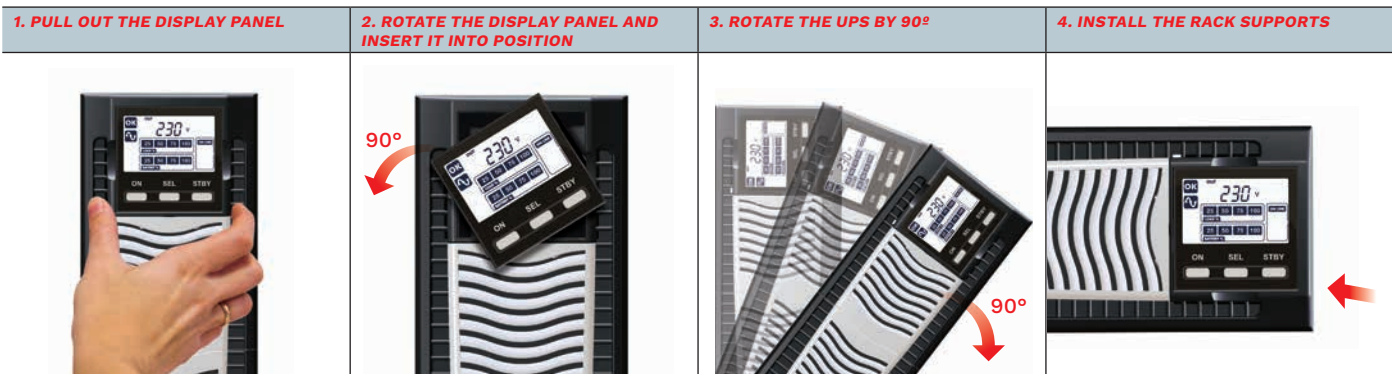

(using the key supplied);

- Low noise (<48 dBA): can be installed in any environment thanks to its high frequency switching inverter and PWM load-dependent digitally controlled fan;
- External bypass option for maintenance with interruption-free switching;
- Operation guaranteed up to 40 °C (the components are designed for high temperatures and are thus subject to less stress at normal temperatures);
- Built-in IEC output sockets with thermal protection.

#### OPERATING MODE SELECTION

Functions can be programmed via software or manually via the front display panel.

- ON LINE: efficiency up to 95%;
- ECO Mode: to increase efficiency (up to to 98%), allows for the selection of LINE INTERACTIVE technology (VI) to power low priority loads from the mains supply;
- SMART ACTIVE: the UPS automatically decides upon the operating mode (VI or VFI) based on the quality of the mains power supply;
- STANDBY OFF: the UPS can be selected to function only when the mains power supply fails (emergency only mode);
- Frequency Converter operation (50 or 60 Hz).

#### HIGH QUALITY OUTPUT VOLTAGE

- Even with non-linear loads (IT loads with a crest factor of up to 3:1);
- High short circuit current on bypass;
- High overload capacity: 150% by inverter (even with mains failure);
- Filtered, stabilised and reliable voltage (double conversion ON LINE technology (VFI compliant with EN62040-3), with filters for the suppression of atmospheric disturbances);
- Power factor correction: UPS input power factor close to 1 and sinusoidal current uptake.

#### HIGH BATTERY RELIABILITY

- Automatic and manual battery test;
- Reduced ripple component (detrimental

to the batteries) using a low ripple current discharge (LCRD) system;

- Batteries are user replaceable without switching off equipment and without interruption to the load (Hot Swap);
- Unlimited extendible runtime using matching Battery cabinets;
- The batteries do not cut in during mains failures of <20 ms (high hold up time) or when the input supply is between 184 V to 276 V.

#### EMERGENCY FUNCTION

This configuration ensures the operation of those emergency systems that require continuous, reliable and long-lasting power supply in the event of a mains power failure, such as emergency lighting, fire detection/extinguishing systems and alarms. When the mains power supply fails, the inverter begins powering the loads with a progressive start up (Soft Start) in order to prevent overload.

#### BATTERY OPTIMISATION

The wide input voltage range and a high hold-up time minimise battery usage and increase efficiency and battery life; for smaller power breaks, energy is drawn from a group of appropriately-sized capacitors.

#### RUNTIME EXPANDABILITY

Optional battery extension packs can be connected to increase UPS runtime. In addition the Sentinel Dual range includes ER versions with no internal batteries and more powerful battery chargers for longer runtimes.

#### ENERGYSHARE

10 A configurable IEC output sockets allow for runtime optimisation by programming the switching off of low priority loads on mains failure; alternatively, emergency loads that are normally not powered when mains is present can be activated.

#### OTHER FEATURES

- Selectable output voltage (220/230/240 V);
- Dual input supplies configuration (SDU 10000 DI and SDU 10000 DI ER);
- Auto-restart when mains power is restored (programmable via software);
- Bypass on: when the machine is switched off, it automatically goes into bypass and battery charge mode;
- Minimum load switch-off;
- Low battery warning;
- Start up delay;
- Total microprocessor and DSP control;
- Automatic bypass without interruption;
- Use of custom power modules;
- Status, measurements and alarms available on standard backlit display;
- UPS digital updating (flash memory upgradeable);
- Output sockets protected with resettable thermal switch;
- Backfeed protection standard: to prevent energy from being fed back to the network;
- Manual switching to bypass.

#### ADVANCED COMMUNICATIONS

- Advanced multi-platform communications for all operating systems and network environments: PowerShield<sup>3</sup> monitoring and shutdown software for Windows operating systems 11, 10, 8, Server 2022, 2019, 2016 and previous versions, Windows Server Virtualization Hyper-V, macOS, Linux, Citrix XenServer and other Unix operating systems;
- Plug and play function;
- USB port;
- RS232 serial port;
- Slot for installation of communications boards.

#### UNITY POWER FACTOR\*

- More power delivered;
- More real output power (W).

#### 2-YEAR WARRANTY

## OPTIONS

| SOFTWARE                 |              | PRODUCT ACCESSORIES                               |
|--------------------------|--------------|---|
| PowerShield <sup>3</sup> | MULTICOM 384 | Universal rails for installation in rack cabinets |
| PowerNetGuard            | MULTICOM 411 | Parallel card*                                    |
| ACCESSORIES              | MULTICOM 421 | Manual bypass single-phase                        |
| NETMAN 208               | MULTI I/O    | Manual bypass three-phase                         |
| MULTICOM 302             | MULTIPANEL   | Modular Manual bypass single-phase*               |
| MULTICOM 352             |              | Modular Manual bypass three-phase*                |
| MULTICOM 372             |              | <i>*not suitable for SDU 4000</i>                 |

## BATTERY CABINET

| MODELS          | <b>BTC SDU 96V BB A5</b><br><b>BTC SDU 96V BB M4</b><br><b>BTC SDU 180V BB A3</b><br><b>BTC SDU 240V BB A3</b> | <b>BTC 1320 180V BB B1 2F</b><br><b>BTC 1320 240V BB B1 2F</b> | <b>BTC SDU 240V BB A3 HS</b><br><b>BTC SDU 240V BB A5 HS</b> |
|-----------------|--|--|--|
| Dimensions [mm] |  |  |  |

**SDU 4000**

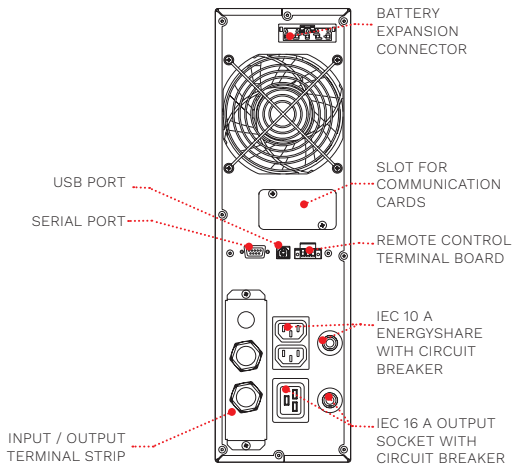

**SDU 5000  
SDU 6000**

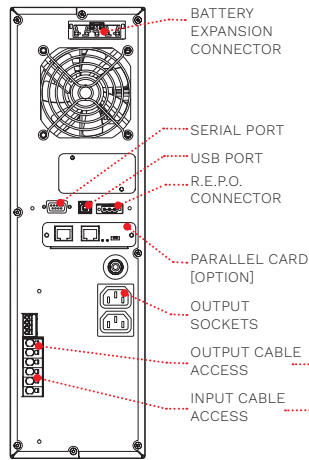

**SDU 5000 PDIST  
SDU 6000 PDIST  
SDU 6000 ER\***

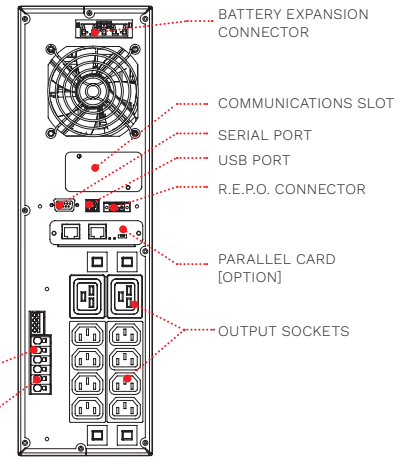

**SDU 8000 - SDU 8000 TM  
SDU 10000 - SDU 10000 TM  
SDU 10000 DI\***

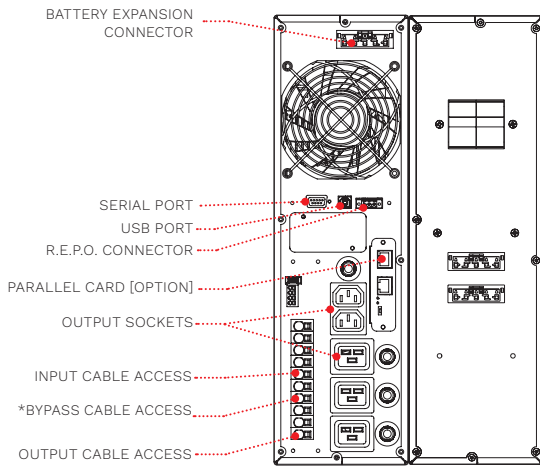

**SDU 10000 DI ER\***

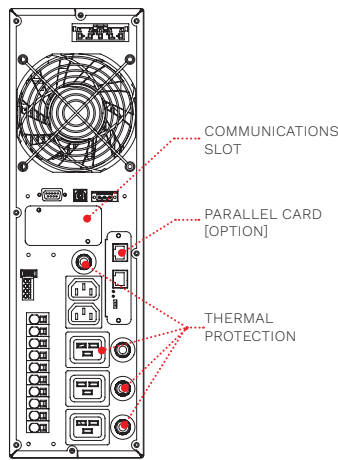

**MODULAR MANUAL BYPASS**

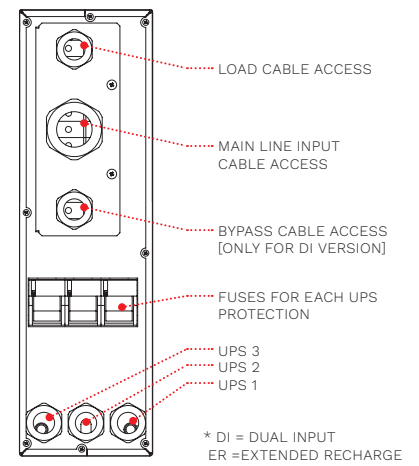

\* DI = DUAL INPUT  
ER = EXTENDED RECHARGE

| MODELS                                   | SDU 4000  | SDU 5000<br>SDU 5000<br>PDIST  | SDU 6000<br>SDU 6000<br>PDIST | SDU<br>6000 ER | SDU 8000  | SDU<br>10000 | SDU<br>10000 DI | SDU<br>10000 DI<br>ER | SDU<br>8000 TM   | SDU<br>10000 TM |
|--|---|--|-------------------------------|----------------|---|--------------|-----------------|-----------------------|--|-----------------|
| <b>INPUT</b>                             |   |  |                               |                |   |              |                 |                       |  |                 |
| Dual Input                               | no  |  |                               |                |   |              | yes             |                       | no   |                 |
| Rated voltage [V]                        | 220 / 230 / 240   |  |                               |                |   |              |                 |                       | 380 / 400 / 415<br>(3W+N+PE)<br>220 / 230 / 240<br>(1W+N+PE) |                 |
| Voltage tolerance [V]                    | 230 ±20%  |  |                               |                |   |              |                 |                       | 400 ±20%<br>230 ±20%   |                 |
| Minimum voltage [V]                      | 184   |  |                               |                |   |              |                 |                       | 318 / 184  |                 |
| Rated frequency [Hz]                     | 50 / 60 ±5  |  |                               |                |   |              |                 |                       |  |                 |
| Power factor                             | >0.98   |  |                               |                |   |              |                 |                       |  |                 |
| Current distortion                       | ≤2%   |  |                               |                |   |              |                 |                       |  |                 |
| <b>BYPASS</b>                            |   |  |                               |                |   |              |                 |                       |  |                 |
| Voltage tolerance [V]                    | 180 / 264 (selectable in ECO Mode or SMART ACTIVE Mode)   |  |                               |                |   |              |                 |                       |  |                 |
| Frequency tolerance                      | Selected frequency ±5% (selectable by user)   |  |                               |                |   |              |                 |                       |  |                 |
| Overload Times                           | <110% continuous, 130% for 1 h, 150% for 10 min, over 150% for 3 s  |  |                               |                |   |              |                 |                       |  |                 |
| <b>OUTPUT</b>                            |   |  |                               |                |   |              |                 |                       |  |                 |
| Nominal power [VA]                       | 4000  | 5000   | 6000                          | 6000           | 8000  | 10000        | 10000           | 10000                 | 8000   | 10000           |
| Active power [W]                         | 3600  | 5000   | 6000                          | 6000           | 8000  | 10000        | 10000           | 10000                 | 8000   | 10000           |
| Rated voltage [V]                        | 220 / 230 / 240 selectable  |  |                               |                |   |              |                 |                       |  |                 |
| Voltage distortion                       | <1% with linear load / <3% with non-linear load   |  |                               |                |   |              |                 |                       |  |                 |
| Frequency [Hz]                           | 50 / 60 selectable  |  |                               |                |   |              |                 |                       |  |                 |
| Static variation                         | 1.5%  |  |                               |                |   |              |                 |                       |  |                 |
| Dynamic variation                        | ≤5% in 20 ms  |  |                               |                |   |              |                 |                       |  |                 |
| Waveform                                 | Sinusoidal  |  |                               |                |   |              |                 |                       |  |                 |
| Crest factor [lpeak/irms]                | 3:1   |  |                               |                |   |              |                 |                       |  |                 |
| <b>BATTERIES</b>                         |   |  |                               |                |   |              |                 |                       |  |                 |
| Type                                     | VRLA AGM maintenance-free lead based  |  |                               |                |   |              |                 |                       |  |                 |
| Recharge time                            | 4-6 h   |  |                               |                |   |              |                 |                       |  |                 |
| <b>OVERALL SPECIFICATIONS</b>            |   |  |                               |                |   |              |                 |                       |  |                 |
| Net weight [kg]                          | 38  | 45   | 46                            | 20             | 19+53   | 20+62        |                 | 21                    | 19+53  | 20+62           |
| Gross weight [kg]                        | 43  | 53   | 54                            | 28             | 83  | 93           |                 | 25                    | 83   | 93              |
| Dimensions (WxDxH) [mm]                  | 131x640x448 tower<br>19"x640x3U rack  |  |                               |                | 2x (131x640x448) tower - 2x (19"x640x3U) rack<br>ER version (131x640x448) tower - (19"x640x3U) rack |              |                 |                       |  |                 |
| Packaging dimensions (WxDxH) [mm]        | 800x600x(240+120)   |  |                               |                | 2x (800x600x240) + 120<br>ER version (800x600x(240+120))  |              |                 |                       |  |                 |
| Efficiency                               | up to 95% ON LINE Mode, 98% ECO Mode  |  |                               |                |   |              |                 |                       |  |                 |
| Protections                              | Overcurrent - short circuit - overvoltage - undervoltage - temperature - excessive low battery  |  |                               |                |   |              |                 |                       |  |                 |
| Parallel Operation                       | no  | Optional Parallel Card   |                               |                |   |              |                 |                       |  |                 |
| Communications                           | USB / RS232 / slot for communications interface / R.E.P.O. + Input contact  |  |                               |                |   |              |                 |                       |  |                 |
| Input Connection                         | Terminal board  |  |                               |                |   |              |                 |                       |  |                 |
| Output sockets                           | Terminal board +<br>2x IEC 320 C13 (10 A) +<br>1x IEC 320 C19 (16 A)  | Terminal board<br>+ 2x IEC 320 C19 (16 A)<br>PDIST: Terminal board<br>+ 8x IEC 320 C13 (10 A)<br>+ 2x IEC 320 C19 (16 A) |                               |                | Terminal board + 2x IEC 320 C13 (10 A) + 3x IEC 320 C19 (16 A)                                      |              |                 |                       |  |                 |
| Standards                                | European directives: LV 2014/35/EU low voltage Directive EMC 2014/30/EU electromagnetic compatibility<br>Directive Standards: Safety IEC EN 62040-1; EMC IEC EN 62040-2; RoHS compliant<br>Classification in accordance with IEC 62040-3 (Voltage Frequency Independent) VFI - SS - 111 |  |                               |                |   |              |                 |                       |  |                 |
| Ambient temp. for the UPS                | 0 °C - +40 °C   |  |                               |                |   |              |                 |                       |  |                 |
| Recommended temperature for battery life | +20 °C - +25 °C   |  |                               |                |   |              |                 |                       |  |                 |
| Range of relative humidity               | 5-95% non-condensing  |  |                               |                |   |              |                 |                       |  |                 |
| Colour                                   | RAL 9005  |  |                               |                |   |              |                 |                       |  |                 |
| Noise level at 1 m (ECO Mode) [dBA]      | <48   |  |                               |                |   |              |                 |                       |  |                 |
| Standard equip. provided                 | USB cable; handles kit  |  |                               |                |   |              |                 |                       |  |                 |





# Sentinel Tower

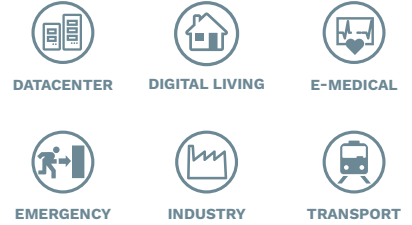

**1:1** 5-6 kVA/kW  
**1-3:1** 8-10 kVA/kW



ONLINE



Tower



Energy Share



Service 1st start



Supercaps UPS



USB plug



## HIGHLIGHTS

- **Small footprint**
- **Power factor 1**
- **High efficiency 95%**
- **Parallelable up to 3 units**
- **3 level inverter**
- **Maintenance bypass**
- **High quality output voltage**

Sentinel Tower is the ideal solution for protecting mission critical systems such as safety devices, telecommunications equipment and IT systems to ensure maximum power reliability.

Sentinel Tower is designed and built using state-of-the-art technology and components to provide maximum protection to the powered loads with no impact on downstream systems and optimised energy savings.

The series includes 5-6 kVA/kW single/single-phase and 8-10 kVA/kW single/three-phase input single-phase output models with ON LINE double conversion technology (VFI): the load is powered continuously by the inverter which supplies a sinusoidal

voltage, filtered and stabilised in terms of form and frequency. Input and output filters provide significant further immunity from mains disturbances and lightning strikes.

In terms of technology and performance, Sentinel Tower is one of the best UPS available on the market today: three-level inverter to achieve 95% efficiency, output power factor 1 to increase in efficiency of system and devices and reduce power system losses. Selectable ECO Mode and SMART ACTIVE Mode functions; new custom diagnostics LCD display, RS232 and USB interfaces with PowerShield<sup>3</sup> software, ESD input, interface slot with optional boards.



## RELIABILITY

- Total microprocessor and DSP control.
- Interruption-free static and manual bypass;
- Specifications guaranteed up to 40 °C (the components are designed to work at high temperatures and thus are subject to less stress at normal temperatures).

## PARALLELABLE

Parallel configuration of 3 units for (2+1) redundant or power parallel system. The UPS continue to operate in parallel even if the connection cable is interrupted (Closed Loop).

## UNITY POWER FACTOR

- More power delivered;
- More real output power (W).

## OPERATING MODE SELECTION

The operating mode can be programmed via software or manually via the front display panel.

- ON LINE: efficiency up to 95%;
- ECO Mode: to increase efficiency (up to 98%), allows for the selection of LINE INTERACTIVE technology (VI) to power low priority loads from the mains supply;
- SMART ACTIVE: the UPS automatically decides upon the operating mode (VI or VFI) based on the quality of the mains power supply;
- STANDBY OFF: the UPS can be selected to function only when the mains power supply fails (emergency only mode);
- Frequency Converter operation (50 or 60 Hz).

## HIGH QUALITY OUTPUT VOLTAGE

- Even with non-linear loads (IT loads with a crest factor of up to 3:1);
- High short circuit current on bypass;
- High overload capacity: 150% by inverter (even with mains failure);
- Filtered, stabilised and reliable voltage (double conversion ON LINE technology - VFI compliant with EN62040-3), with filters for the suppression of atmospheric disturbances;
- Power factor correction: UPS input power factor close to 1 and sinusoidal current uptake.

## SIMPLIFIED INSTALLATION

- UPS can be installed on a single-phase or three-phase distribution network STW 8000 and STW 10000;
- Output terminal board + 2 IEC sockets for powering local consumers (computers, devices, etc.);
- Simplified positioning (built-in castors).

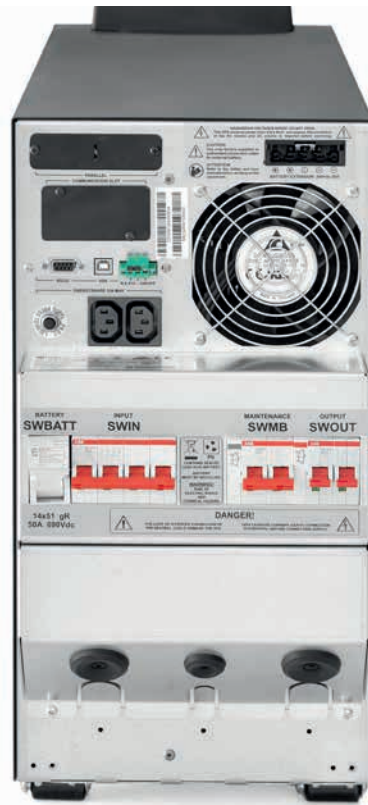

## HIGH BATTERY RELIABILITY

- Automatic and manual battery test.
- Proper battery care is critical to ensuring correct UPS operation in emergency conditions. The Riello UPS battery care system consists of a series of features and capabilities to optimise battery management and obtain the best performance and operating life possible;
- Unlimited extendible runtime using matching Battery cabinets;
- The batteries do not cut in during mains failures of <20 ms (high hold up time) or when the input supply is between 184 V to 276 V.

## LOW IMPACT ON THE MAINS

Sinusoidal uptake of input current on single-phase/single-phase series.

## RUNTIME EXPANDABILITY

Optional battery extension packs can be connected to increase UPS runtime. In addition the Sentinel Tower range includes ER versions with no internal batteries and more powerful controlled battery chargers 6 A for longer runtimes.

## OTHER FEATURES

- Advanced diagnostics: status, measurements and alarms available on new custom LCD display;
- Low noise (<45 dBA): can be installed in any environment thanks to its high



frequency switching inverter and PWM load-dependent digitally controlled fan (>20 kHz, value above audible range);

- Auto restart (automatic when mains supply is restored, programmable via software);
- Backfeed protection standard: to prevent energy from being fed back to the network;
- UPS digital updating (flash upgradeable).

**ADVANCED COMMUNICATIONS**

- Compatible with RielloConnect remote monitoring;
- Advanced multi-platform communications for all operating systems and network environments: PowerShield<sup>3</sup> monitoring and shutdown software for Windows operating systems 11, 10, 8, Server 2022, 2019, 2016 and previous versions, Windows Server Virtualization Hyper-V, macOS, Linux, Citrix XenServer and other Unix operating systems;
- RS232 serial and USB ports;
- Plug and play function;
- Slot for installation of communications boards.

**DETAILS**

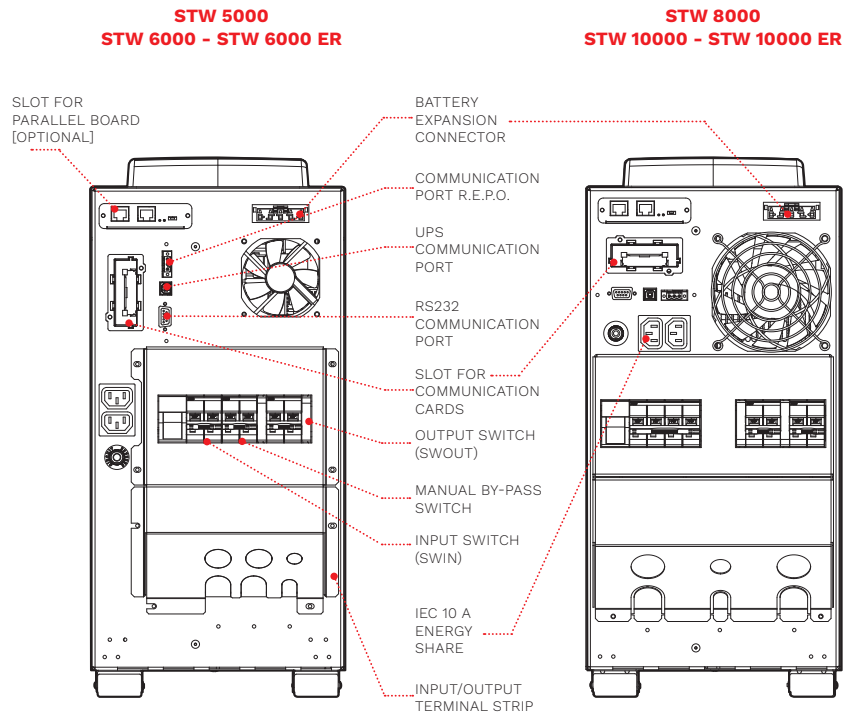

**OPTIONS**

|                            |
|----------------------------|
| <b>SOFTWARE</b>            |
| PowerShield <sup>3</sup>   |
| PowerNetGuard              |
| <b>ACCESSORIES</b>         |
| NETMAN 208                 |
| MULTICOM 302               |
| MULTICOM 352               |
| MULTICOM 372               |
| MULTICOM 384               |
| MULTICOM 411               |
| MULTICOM 421               |
| MULTI I/O                  |
| MULTIPANEL                 |
| Manual Bypass MBB 100 A 2P |

|  |
|--|
| <b>PRODUCT ACCESSORIES</b>   |
| Isolation transformer (WxDxH) mm / kg: 500x400x500 / 50 (only for STW 5000-6000 VA models) |
| Parallel kit   |

**BATTERY CABINET**

|                 |   |   |
|-----------------|---|---|
| <b>MODELS</b>   | <b>BTC STW 180V BB A3</b><br><b>BTC STW 180V BB M1</b><br><b>BTC STW 240V BB A3</b><br><b>BTC STW 240V BB M1</b><br><b>BTC STW 240V AB A3</b> | <b>BTC 1320 180V BB B1 2F</b><br><b>BTC 1320 240V BB B1 2F</b><br><b>BTC 1320 240V AB B1 2F</b> |
| Dimensions [mm] |   |   |



| MODELS  | STW 5000  | STW 6000 | STW 6000 ER | STW 8000   | STW 10000 | STW 10000 ER |
|---|---|----------|-------------|--|-----------|--------------|
| <b>INPUT</b>  |   |          |             |  |           |              |
| Rated voltage [V]                                   | 220 / 230 / 240   |          |             | 380 / 400 / 415 (3W+N+PE)<br>220 / 230 / 240 (1W+N+PE) |           |              |
| Voltage tolerance [V]                               | 230 ±20%  |          |             | 400 ±20% / 230 ±20%                                    |           |              |
| Minimum voltage [V]                                 | 184   |          |             | 318 / 184  |           |              |
| Maximum operating voltage [V]                       | 276   |          |             | 478 / 276  |           |              |
| Rated frequency [Hz]                                | 50 / 60 ±5  |          |             |  |           |              |
| Power factor  | >0.98   |          |             |  |           |              |
| Current distortion                                  | ≤5% <sup>1</sup>  |          |             |  |           |              |
| <b>BYPASS</b>                                       |   |          |             |  |           |              |
| Voltage tolerance [V]                               | 180 / 264 (selectable in ECO Mode or SMART ACTIVE Mode)   |          |             |  |           |              |
| Frequency tolerance                                 | Selected frequency ±5% (selectable by user)   |          |             |  |           |              |
| Overload times                                      | <110% continuous, 130% for 1 h, 150% for 10 min, over 150% for 3 s  |          |             |  |           |              |
| <b>OUTPUT</b>                                       |   |          |             |  |           |              |
| Nominal power [VA]                                  | 5000  | 6000     | 6000        | 8000   | 10000     | 10000        |
| Active power [W]                                    | 5000  | 6000     | 6000        | 8000   | 10000     | 10000        |
| Rated voltage [V]                                   | 220 / 230 / 240 selectable  |          |             |  |           |              |
| Voltage distortion                                  | <1% with linear load / <3% with non-linear load   |          |             |  |           |              |
| Frequency [Hz]                                      | 50 / 60 selectable  |          |             |  |           |              |
| Static variation                                    | 1.5%  |          |             |  |           |              |
| Dynamic variation                                   | ≤5% in 20 ms  |          |             |  |           |              |
| Waveform  | Sinusoidal  |          |             |  |           |              |
| Crest factor [I <sub>peak</sub> /I <sub>rms</sub> ] | 3:1   |          |             |  |           |              |
| <b>BATTERIES</b>                                    |   |          |             |  |           |              |
| Type  | VRLA AGM maintenance-free lead based  |          |             |  |           |              |
| Recharge time                                       | 4-6 h   |          |             |  |           |              |
| <b>OVERALL SPECIFICATIONS</b>                       |   |          |             |  |           |              |
| Net weight [kg]                                     | 62  | 63       | 25          | 78   | 84        | 28           |
| Gross weight [kg]                                   | 68  | 69       | 31          | 84   | 90        | 34           |
| Dimensions (WxDxH) [mm]                             | 250x698x500   |          |             |  |           |              |
| Packaging dimensions (WxDxH) [mm]                   | 300x800x702   |          |             |  |           |              |
| Efficiency  | up to 95% ON LINE Mode, 98% ECO Mode  |          |             |  |           |              |
| Protections   | Overcurrent - short circuit - overvoltage - undervoltage - temperature - excessive low battery  |          |             |  |           |              |
| Parallel operation                                  | Optional Parallel Card  |          |             |  |           |              |
| Communications                                      | USB / RS232 / slot for communications interface / R.E.P.O. + Input contact  |          |             |  |           |              |
| Input connection                                    | Terminal board  |          |             |  |           |              |
| Output sockets                                      | Terminal board + 2x IEC 320 C13 (10 A)  |          |             |  |           |              |
| Standards   | European directives: LV 2014/35/EU low voltage Directive EMC 2014/30/EU electromagnetic compatibility<br>Directive Standards: Safety IEC EN 62040-1; EMC IEC EN 62040-2; RoHS compliant<br>Classification in accordance with IEC 62040-3 (Voltage frequency Independent) VFI - SS - 111 |          |             |  |           |              |
| Ambient temperature for the UPS                     | 0 °C - +40 °C   |          |             |  |           |              |
| Recommended temperature for battery life            | +20 °C - +25 °C   |          |             |  |           |              |
| Range of relative humidity                          | 5-95% non-condensing  |          |             |  |           |              |
| Colour  | RAL 9005  |          |             |  |           |              |
| Noise level at 1 m (ECO Mode) [dBA]                 | <48   |          |             |  |           |              |
| Standard equipment provided                         | USB cable   |          |             |  |           |              |
| Moving the UPS                                      | castors   |          |             |  |           |              |

<sup>1</sup> for single-phase input.

# Sentryum



DATACENTER



E-MEDICAL



EMERGENCY



INDUSTRY



TRANSPORT

**1-3:1** 10-20 kVA/kW  
**3:3** 10-120 kVA/kW



ONLINE



Tower



Energy Share



Service 1st start



SmartGrid ready



Supercaps UPS



USB plug

## HIGHLIGHTS

- **Extensive range of solutions**
- **Compactness**
- **Efficiency up to 96.6%**
- **High power availability**
- **Smart battery management**
- **Maximum reliability**
- **Flexibility of use**
- **Graphic touch screen display**

The rapid evolution of IT technologies, additional focus on environmental matters and complexity of critical applications lead to a need for more flexible, efficient, secure and interconnected power protection solutions.

The Sentryum 10-120 kVA/kW offers the best combination of power availability, energy efficiency and global performance ensuring installation and running cost savings. It is the very latest Riello UPS development resulting in a third-generation transformer-free UPS, originally introduced into the market over twenty three years ago. This ultimate solution is rated at output power factor 1 and defined as ON LINE double conversion technology in accordance with VFI-SS-111 classification (as set out in standard IEC

EN 62040-3). The Sentryum series is a transformer-free UPS available in 10-15-20 kVA/kW models with three-phase/single-phase input and single-phase output and 10-15-20-30-40-60-80-100-120 kVA/kW models with three-phase input and output.

Sentryum is designed and built using state-of-the-art technology and components. It applies the advanced technologies such as a DSP (Digital Signal Processor), dual core microprocessors, three-level inverter circuits and resonant controls to provide maximum protection to critical loads with no impact on downstream systems, all whilst maintaining optimised energy savings. With a unique control system, it makes it possible to reduce the inverter



output harmonic voltage distortion (<1% at resistive linear load and <1.5% at non-linear load) and provide a rapid response to all load variations, ensuring an outstanding sinewave form during all conditions.

Furthermore, Riello UPS' technological advances in digital control and power components contribute to minimise the impact on the grid.

Sentryum provides the solution to installation problems in systems where the mains electricity supply has limited power available, where the UPS is supported by a generator, or where there are compatibility problems with loads that generate harmonic currents.

### EXTENSIVE RANGE OF SOLUTIONS

Sentryum has been conceived to optimise the specific requirements by enhancing the installation flexibility.

Riello UPS offers Sentryum in four different frame solutions to satisfy any critical power demand and application. Three of the frame types are available for the Sentryum 10-60 kVA/kW power ratings:

**Compact (CPT):** this cabinet frame is specifically devised to offer a compact but efficient solution for tailored applications; thanks to the ultimate technologies applied, this solution offers unmatched power (up to 20 kVA @ pf 1) and autonomy (12 minutes of backup time at typical load) in an extremely reduced space.

**Active (ACT):** this solution offers an optimised degree of flexibility to meet different power requirements and battery autonomies. The solution offered is extremely compact but exceptionally powerful, with the possibility to deliver up to 60 kVA (@ pf 1). The ACT model allows to build one or two levels of internal battery backup time (NB this does not apply to the 60 kVA/kW model, which does not allow the installation of internal batteries).

**Xtend (XTD):** this version is the most flexible solution available to meet various installation requirements and power demands. In an extremely small footprint, it is possible to build up to three-levels of battery backup time. In addition, the mechanical design makes it possible to install an isolation transformer or easily change the degree of protection from IP20 to IP21 or even IP31. The installation of a dedicated optional seismic kit allows the XTD model to become compliant to ICC-ES AC 156 (2020) too.

The fourth frame is unique for the Sentryum 80-120 kVA/kW power ratings:



Rear view Sentryum Compact.

**S3T 80, S3T 100, S3T 120.** The layout of these models doesn't allow for the installation of internal batteries and transformers. However, as per the XTD model, the mechanical design does make it possible to easily change the degree of protection from IP20 to IP21 or even IP31. In addition, the S3T 80-120 models can become compliant to ICC-ES AC 156 (2020) simply by adding the optional seismic kit.

### COMPACTNESS

Modern guidelines and sustainable best practices direct us to conceive and design UPS with a particular focus on the entire product life cycle, applying ultimate but resilient technologies, recyclable materials and miniaturisation of assemblies whilst ensuring the systems' global reliability, which is pivotal for any UPS. The internal card layout has been optimised to reduce the number of components, interconnections and space required, whilst at the same time increasing reliability and Mean Time Between Failures (MTBF), which helps to minimise operational expenditure such as service operations and maintenance costs.

The result is an outstanding range of four different solutions providing powerful but compact designs as follows:

#### Sentryum 10-60 kVA/kW power ratings

- **Compact:** less than 0.25 m<sup>2</sup> footprint and only 0.17 m<sup>3</sup> of volume.
- **Active:** less than 0.35 m<sup>2</sup> footprint and only 0.33 m<sup>3</sup> of volume.
- **Xtend:** less than 0.4 m<sup>2</sup> footprint and less than 0.5 m<sup>3</sup> of volume.

#### Sentryum 80-120 kVA/kW power ratings

- **S3T 80, S3T 100, S3T 120:** less than 0.42 m<sup>2</sup> footprint and less than 0.67 m<sup>3</sup> of volume.



Graphic touch screen display.

| MECHANICAL CHARACTERISTICS | SENTRYUM COMPACT-CPT (10-20)                                   | SENTRYUM ACTIVE-ACT (10-60)                                     | SENTRYUM XTEND-XTD (10-60)  | SENTRYUM S3T 80-120 (80-120)  |
|----------------------------|--|---|---|---|
| Cabinet layout description | Free standing type with wheels and terminals/ switches on rear | Free standing type with wheels and terminals/ switches on front | Free standing type with wheels and terminals/ switches on front                   | Free standing type with wheels and terminals/ switches on front                   |
| Range [kVA/kW]             | 10-15-20 (1 Ph)<br>10-15-20 (3 Ph)                             | 10-15-20 (1 Ph)<br>10-15-20-30-40-60 (3 Ph)                     | 10-15-20 (1 Ph)<br>10-15-20-30-40-60 (3 Ph)                                       | 80-100-120 (3 Ph)   |
| Battery                    | Space for: 40 blocks   | Space for: 2x40 blocks (No internal battery for 60kVA)          | Space for: 3x40 blocks (3x40x9Ah for 60kVA model, not 7Ah)                        | No internal battery   |
| Ventilation                | Forced, front to rear  | Forced, front to rear   | Forced, front to rear (Air filter door as option)                                 | Forced, front to rear (Air filter door as option)                                 |
| Cabinet IP rating          | IP20 finger proof (either with cabinet doors open or closed)   | IP20 finger proof (either with cabinet doors open or closed)    | IP20 finger proof (either with cabinet doors open or closed)<br>IP21/31 as option | IP20 finger proof (either with cabinet doors open or closed)<br>IP21/31 as option |
| Cable input                | Bottom (rear)  | Bottom (front)  | Bottom (front)  | Bottom (front)  |

### HIGH EFFICIENCY

Sentryum is a true ON LINE double conversion UPS system providing the very highest levels of power availability, flexibility and unrivalled energy efficiency with superior performance for any small Data Center and mission critical applications.

With a full power rating (kVA=kW unity pf), the Sentryum provides the maximum available power without any de-rating. Thanks to the three-level IGBT inverter topology (constructed using modules rather than discrete components) and innovative digital controls, the Sentryum provides up to 96.6% overall efficiency, whilst maintaining a reduced number of components, connections and ribbon cables, which increases the overall system reliability thanks to a higher MTBF.

Riello UPS' advanced average current mode digital PFC control and state-of-the-art three-level NPC inverters work at high frequency (18 kHz for 10-60 kVA/kW, 16kHz for 80-120 kVA/kW), which contributes to minimising the UPS's impact on the grid and helps to reduce the overall operational costs and energy bills.

Sentryum applies a zero impact onto its power source, whether this is from the mains power supply or a generator, this results in:

- Very low input current distortion <3%;
- Near unity input power factor 0.99;
- Power walk-in function that ensures progressive rectifier start up;
- Start up delay function, to sequentially restart the rectifiers once the mains power supply is restored if there are

several UPS within the overall system;;

- In addition, Sentryum provides a filtering and power factor correction function within the power network upstream of the UPS, thus eliminating harmonic components and reactive power generated by the power utilities.

### HIGH POWER AVAILABILITY

Sentryum's fully rated design delivers full power (kVA=kW) regardless of the load power factor or operating temperature (full-rated power is available up to 40 °C). Furthermore, Sentryum's advanced digital control makes it possible to deliver up to 270% inverter current for 200 ms and 150% for 300 ms. This high overcurrent availability enables the system to deal with sudden peak loads (without static bypass intervention) and provide the short circuit current if required during operation on battery.

The innovative input stage design provides extremely high battery recharging current, whilst at the same time an energy efficient conversion process during battery operation to reduce the power wasted and to increase the autonomy time compared to legacy DC/AC converters.

### SMART BATTERY MANAGEMENT

Proper battery care is critical to ensure the correct operation of the UPS during emergency conditions. The Riello UPS Smart Battery Management system consists of a series of features and capabilities to optimise battery management and obtain the best performance and operating life possible.

Battery recharging: Sentryum is suitable for use with conventional hermetically sealed lead-acid (VRLA), AGM and GEL batteries, Open Vented and Nickel Cadmium batteries.

Sentryum is also compatible with alternative backup power sources such as Li-Ion batteries and Supercapacitors.

Its superior battery charging current availability, i.e. up to 30 Amperes for the 40-120 kVA/kW power range, means that the Sentryum can be utilised within any extended battery autonomy application. Depending on the battery type, different charging methods are available:

- One-level voltage recharge, typically used for widely available VRLA AGM batteries.
- Two-level voltage recharge according to IU specification.
- Cyclical recharge system to reduce electrolyte consumption and lengthen the life of VRLA batteries.

The battery management system also incorporates:

- Recharge voltage compensation based on ambient temperature to prevent excessive battery charging or overheating.
- Battery tests to diagnose in advance any reduction in performance or problems with the batteries.
- Deep discharge protection: during extended low-load discharges, the end of discharge voltage is increased - as recommended by battery manufacturers - to prevent damage or reduced battery performance.
- Ripple current: recharge ripple current





(residual AC component at low frequency) is one of the main causes of reduced reliability and battery life. Using a high frequency battery charger, Sentryum reduces this value to negligible levels, prolonging battery life and maintaining high performance over a long period of time.

- Wide voltage range: the rectifier is designed to operate within a wide input voltage range (up to -40% at half load), reducing the need for battery discharge and thus helping to extend battery life.

Sentryum allows a wide battery block range per string; the standard 20+20 battery blocks @ 12 V with neutral central point can be adjusted from 15+15 to 22+22 battery blocks (nominal power de-rating is automatically applied below 20+20 battery block configuration).

#### MAXIMUM RELIABILITY AND AVAILABILITY

Distributed parallel configuration of up to 8 units per redundant (N+1) or capacity parallel system grants exceptional expandability. The UPS continue to operate in parallel even if the connection cable is interrupted (Closed Loop).

Advanced technology and use of high performance components allows Sentryum to provide exceptional performance and utmost reliability:

- The smallest overall footprint is only 0.35 m<sup>2</sup> for Sentryum 40 kVA/kW with two strings of 40 battery blocks;
- The input power stage (IGBT rectifier) ensures an input power factor close to 1 with extremely low current distortion, avoiding the need for bulky and expensive filters;
- The Sentryum's unity output power factor makes it suitable for any Data Center application ensuring full power availability without downgrading no matter the load power factor range (typically from 0.9 lagging to 0.9 leading);
- Extremely low output THDV under any circumstances provides a perfect sinewave and therefore a reliable power supply for the load preventing and disturbances from affecting the network users;
- More active power than a traditional UPS, guaranteeing a greater margin when sizing UPS for potential future load increases;
- More energy to face sudden load increase or clear output short circuits due to appliance failures downstream;
- Thanks to the principle of smart ventilation, Sentryum manages the fan speed and airflow in accordance with



- the room temperature and load level. This preserves the lifespan of the fans, whilst at the same time reduces noise levels and overall power consumption due to unnecessary UPS ventilation. Furthermore, the overall UPS high efficiency reduces any losses and the need for high levels of ventilation compared to older legacy UPS. This results in a decrease in the overall noise level at the nominal load and a reduction in the number of fans required, which significantly benefits the operating and maintenance costs.
- Fan failure monitoring: each fan is monitored individually for the 60-120 kVA/kW power ratings as standard, while this feature is a factory-fitted option for the 10-40 kVA/kW power ratings (available for Xtend version only). In the event of a fan failure, an alarm will be raised on the UPS display and via remote monitoring device (if present); this immediately informs the user so

that necessary actions can be taken to restore the system to correct operation..

#### FLEXIBILITY

With its flexible range of four solutions, configurations, performances, accessories and options, Sentryum is suitable for use in a wide range of applications:

- Suitable for powering capacitive loads, such as blade servers, without any reduction in active power from 0.9 lead to 0.9 lag;
- ON LINE, ECO, SMART ACTIVE and STANDBY OFF operating Modes - compatible with central power supply systems (CPSS) applications;
- Frequency Converter Mode;
- Cold Start to switch on the UPS even when there is no mains power present;
- S3T 20 XTEND version: cabinet (440x840x1320 mm WxDxH) for optimised solutions when medium to long-term runtimes are required (up to one hour back up time for a 20 kVA/kW at typical load rate);
- Parallel configuration up to 8 units for three-phase version;
- Optional temperature sensor for external battery cabinets, to assist recharge voltage compensation;



Sentryum S3T 120 with open door.

- High power battery chargers to optimise charge time in the event of long runtimes;
- Dual input mains power supply (not applicable on Compact, optional for Active and S3T 80-120, standard on Xtend version);
- Isolation transformers for modifying the neutral earthing (separate power sources), or for galvanic isolation between the input and output (optional inside Xtend, external for Compact, Active or S3T 80-120 versions);
- Mechanical fitting for a higher rating of IP protection either IP21 or IP31 on Xtend and S3T 80-120 versions;
- Air filter door on Xtend and S3T 80-120 versions to protect UPS placed in dusty environment;
- Compatibility with alternative backup energy sources rather than lead batteries (NiCd or Li-ion batteries or Supercapacitors);
- Different sized battery cabinets and capacities, for extended runtimes.

#### ADVANCED COMMUNICATIONS

Sentryum is equipped with a coloured graphic touch screen display providing UPS information, measurements, operating states and alarms in different languages. The default screen displays the UPS status, graphical indication of the energy path through the UPS and the operational condition of the various assemblies (rectifier, batteries, inverter, bypass) within the UPS.

Furthermore, the user interface includes a UPS status led bar which delivers immediate and clear information regarding the overall status of the UPS by changing the colour (light blue, dark blue, orange

and red) according with the operating mode and condition.

- Advanced multi-platform communications for all operating systems and network environments: PowerShield<sup>3</sup> monitoring and shutdown software included for Windows operating systems 11, 10, 8, Hyper-V, Server 2022, 2019, 2016 and previous versions, Windows Server Virtualization Hyper-V, macOS, Linux, Citrix XenServer and other Unix operating systems;
- Compatible with VMware infrastructures to perform graceful shutdown of hosts and clusters; to perform Vmotion and prioritised shutdown of VM thanks to NetMan 208 Network card;
- Compatible with Nutanix and Syneto infrastructures to perform graceful shutdown of hosts; to perform prioritised shutdown of VM thanks to NetMan 208 Network card;
- Compatible with RielloConnect (remote monitoring service);
- RS232 port on RJ10 connector and USB ports;
- 2 slots for the installation of optional communications accessories such as network adaptors and volt free contacts etc;
- Embedded contact interface which includes 5 programmable inputs and 4 programmable outputs;
- R.E.P.O. Remote Emergency Power Off for switching off the UPS via a remote emergency button;
- Graphic display panel for remote connection.



*Sentryum Xtend 60 with open door.*



**COMPACT 10-20 kVA  
(front)**

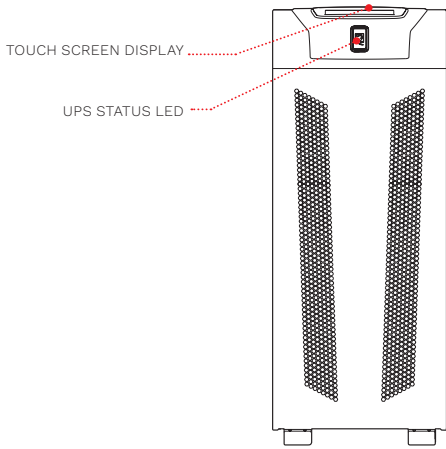

**COMPACT 10-20 kVA  
(rear)**

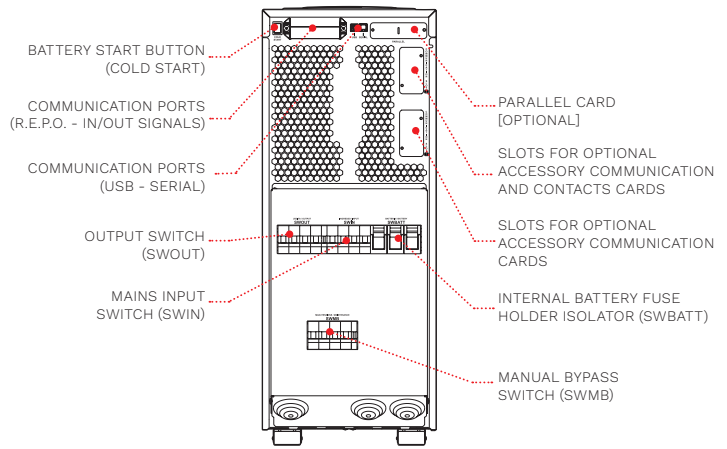

**ACTIVE 10-40 kVA  
(front)**

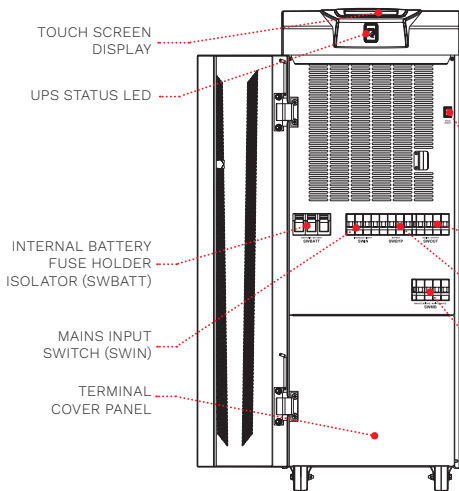

**ACTIVE 10-40 kVA  
(rear)**

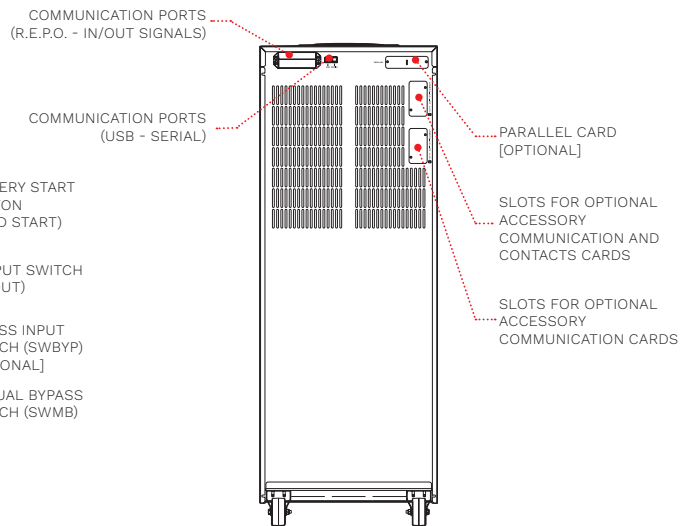

**ACTIVE 60 kVA  
(front)**

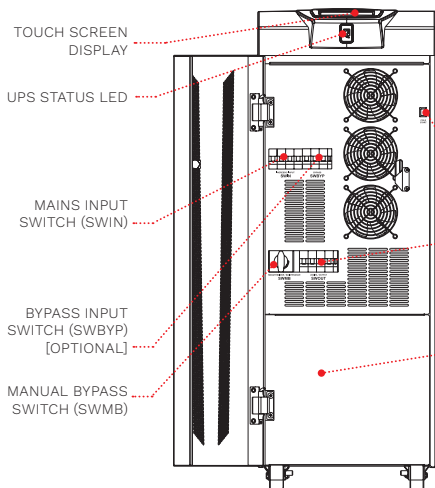

**ACTIVE 60 kVA  
(rear)**

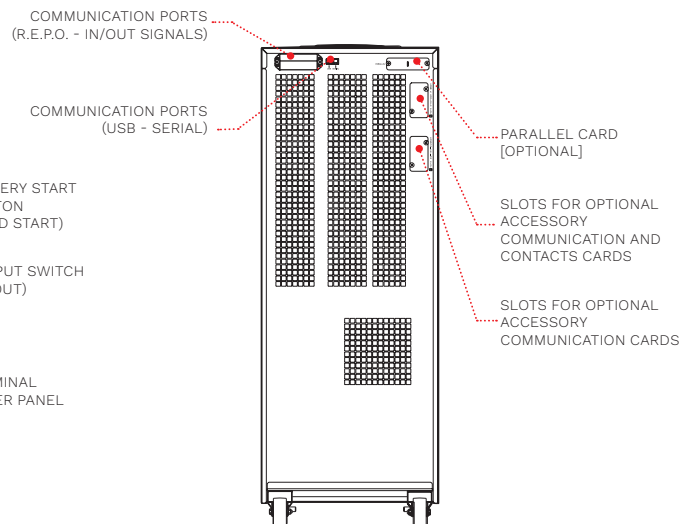

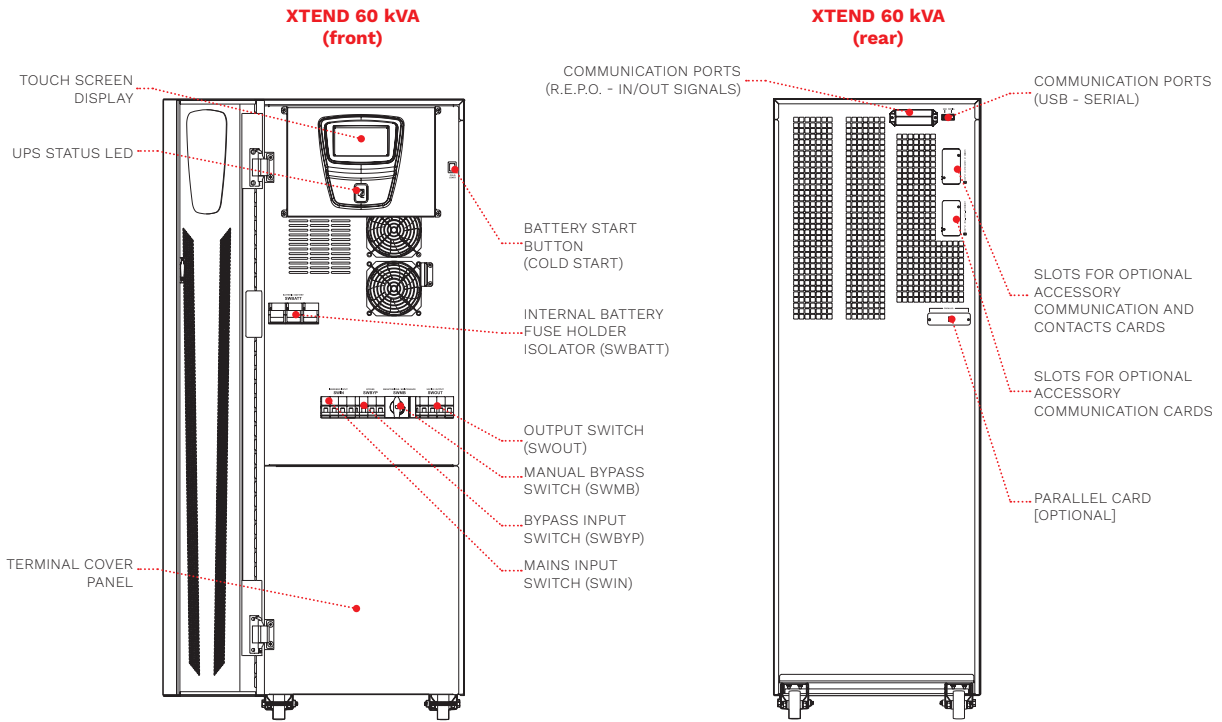
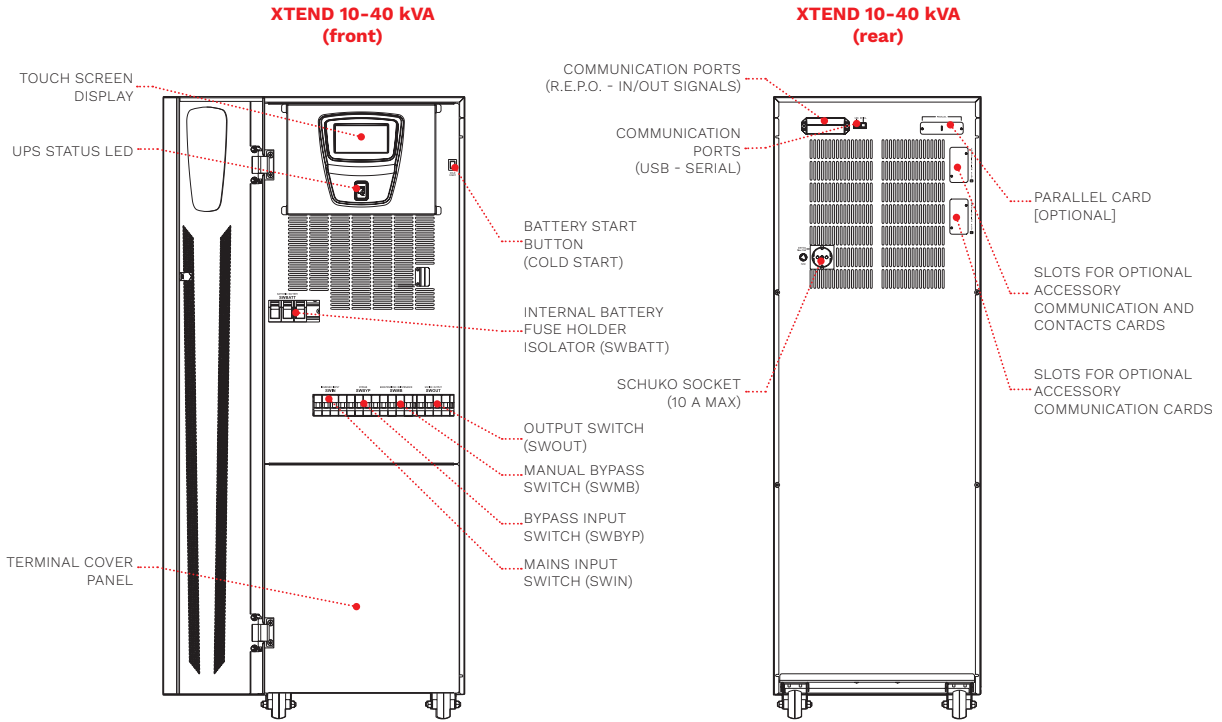

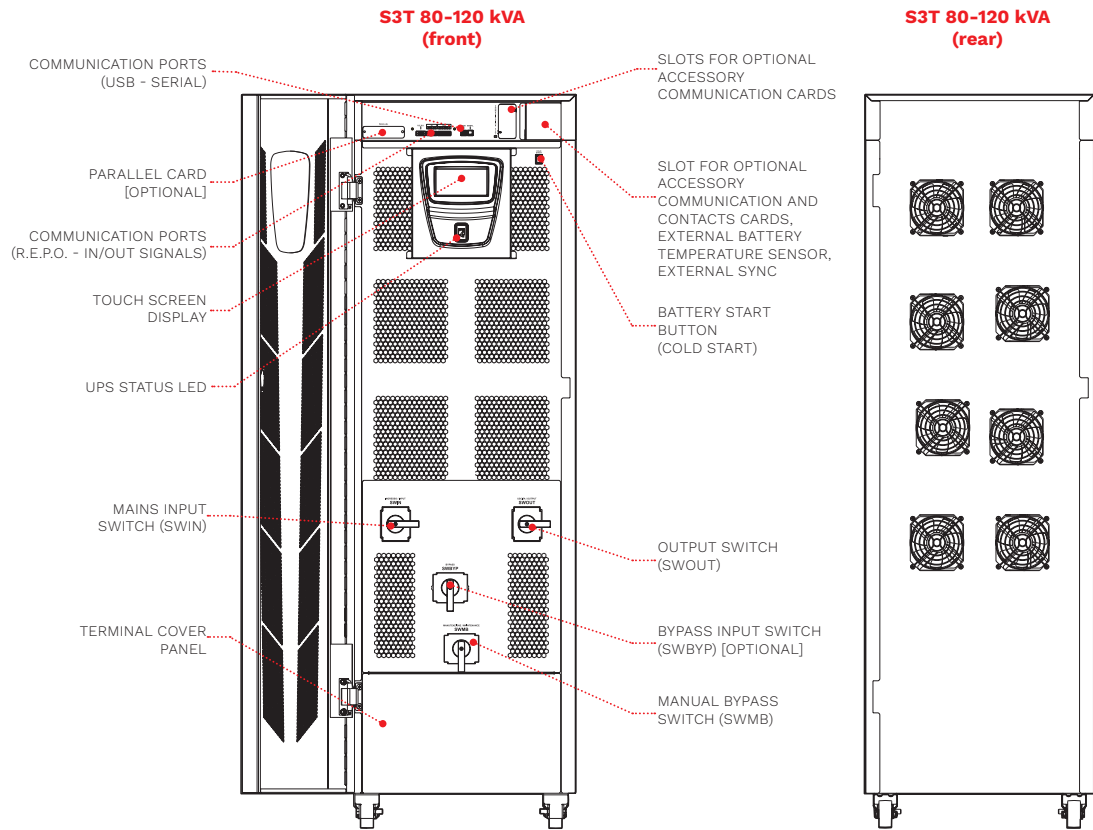

## BATTERY CABINET

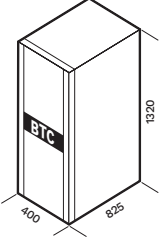
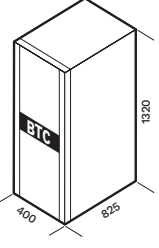
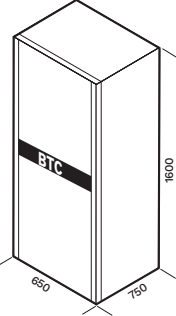
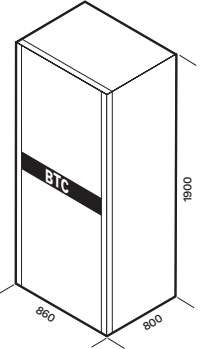
| MODELS          | BTC 1320 480V BB T4 3F<br>BTC 1320 480V BB T2 3F<br>BTC 1320 480V AB T5 3F        | BTC 1320 480V BB T5 3F<br>BTC 1320 480V AB T5 3F                                  | BTC 1600 480V BB S5 3T<br>BTC 1600 480V AB S5 3T   | BTC 1900 480V BB V6 3T<br>BTC 1900 480V BB V7 3T<br>BTC 1900 480V BB V8 3T<br>BTC 1900 480V BB V9 3T<br>BTC 1900 480V AB V9 3T  |
|-----------------|---|---|--|---|
| UPS MODELS      | S3M 10-20 kVA/kW <sup>2</sup><br>S3T 10-40 kVA/kW <sup>2</sup>                    | S3M 10-20 kVA/kW <sup>2</sup><br>S3T 10-60 kVA/kW <sup>2</sup>                    | S3M 10-20 kVA/kW <sup>2</sup><br>S3T 10-80 kVA/kW <sup>2</sup>   | S3M 15-20 kVA/KW <sup>2</sup><br>S3T 15-120 kVA/KW <sup>2</sup>   |
| Dimensions [mm] |  |  | <br><i>Conditions apply on S3T 80 kVA/kW UPS model</i> | <br><i>BTC 1900 480V BB V6 3T and BTC 1900 480V BB V7 3T: Conditions apply on S3T 120 kVA/kW UPS model</i> |

<sup>2</sup> According with battery cabinet fuse associated.

## OPTIONS

### SOFTWARE

PowerShield<sup>3</sup>  
PowerNetGuard

### ACCESSORIES

NETMAN 208  
MULTICOM 302  
MULTICOM 352  
MULTICOM 384  
MULTICOM 411  
MULTICOM 421  
MULTI I/O  
MULTIPANEL  
MBB 100 A 2P  
MBB 125 A 4P  
MBB 400 A 4P

### PRODUCT ACCESSORIES

Battery temperature sensor  
ER battery charger  
Parallel Kit  
MULTICOM 392  
UPS with internal isolation transformers (XTEND version)  
IP rating IP21/IP31 (XTEND and S3T 80-120 versions)  
Dual Input Kit (ACT and S3T 80-120 versions)  
Front door air filter (XTD and S3T 80-120 versions)  
Fan failure alarm for 10-40 kVA (XTD version)  
Seismic kit (XTD and S3T 80-120 versions)  
ENERGYMANAGER

| MODELS                                   | S3M<br>CPT-ACT-XTD<br>10 <sup>BAT</sup>  | S3M<br>CPT-ACT-XTD<br>15 <sup>BAT</sup> | S3M<br>CPT-ACT-XTD<br>20 <sup>BAT</sup> | S3T<br>CPT-ACT-XTD<br>10 <sup>BAT</sup>                   | S3T<br>CPT-ACT-XTD<br>15 <sup>BAT</sup> | S3T<br>CPT-ACT-XTD<br>20 <sup>BAT</sup> |
|--|--|---|---|---|---|---|
| <b>INPUT</b>                             |  |   |   |   |   |   |
| Rated voltage [V]                        | 380 / 400 / 415 three-phase + N<br>220 / 230 / 240 single-phase + N  |   |   | 380 / 400 / 415 three-phase + N                           |   |   |
| Rated frequency [Hz]                     | 50 / 60  |   |   |   |   |   |
| Voltage tolerance [V]                    | 230 / 400 ±20% @ full load <sup>1</sup>  |   |   | 400 ±20% @ full load <sup>1</sup>                         |   |   |
| Frequency tolerance [Hz]                 | 40 - 72  |   |   |   |   |   |
| Power factor @ full load                 | 0.99   |   |   |   |   |   |
| Current distortion                       | THDI ≤3%   |   |   |   |   |   |
| <b>BYPASS</b>                            |  |   |   |   |   |   |
| Rated voltage [V]                        | 220 / 230 / 240 single-phase + N   |   |   | 380 / 400 / 415 three-phase + N                           |   |   |
| Number of phases                         | 1 + N  |   |   | 3 + N   |   |   |
| Voltage tolerance (ph-N) [V]             | from 180 (adjustable 180-200) to 264 (adjustable 250-264) referring to neutral   |   |   |   |   |   |
| Rated frequency [Hz]                     | 50 or 60 (selectable)  |   |   |   |   |   |
| Frequency tolerance                      | ±5% (selectable)   |   |   |   |   |   |
| Bypass overload                          | 110% infinite, 125% for 60 min, 150% for 10 min  |   |   |   |   |   |
| <b>OUTPUT</b>                            |  |   |   |   |   |   |
| Nominal power [kVA]                      | 10   | 15                                      | 20                                      | 10  | 15                                      | 20                                      |
| Active power [kW]                        | 10   | 15                                      | 20                                      | 10  | 15                                      | 20                                      |
| Power factor                             | 1 up to 40 °C  |   |   |   |   |   |
| Number of phases                         | 1 + N  |   |   | 3 + N   |   |   |
| Rated voltage [V]                        | 220 <sup>1</sup> / 230 / 240 single-phase + N (selectable)   |   |   | 380 <sup>1</sup> / 400 / 415 three-phase + N (selectable) |   |   |
| Rated frequency [Hz]                     | 50 or 60   |   |   |   |   |   |
| Frequency stability on battery operation | 0.01%  |   |   |   |   |   |
| Voltage stability                        | ±1%  |   |   |   |   |   |
| Dynamic stability                        | EN 62040-3 class performance 1 non-linear load   |   |   |   |   |   |
| Voltage distortion                       | <1% with resistive linear load / ≤1.5% with non-linear load  |   |   |   |   |   |
| <b>BATTERIES</b>                         |  |   |   |   |   |   |
| Type                                     | VRLA AGM/GEL/NiCd/Li-ion/SuperCaps   |   |   |   |   |   |
| Recharging method                        | One level, Two level, Cyclic recharge (selectable)   |   |   |   |   |   |
| <b>OVERALL SPECIFICATIONS</b>            |  |   |   |   |   |   |
| Weight without batteries [kg]            |  |   |   |   |   |   |
| CPT - ACT - XTD (10-60)                  | 48-72-103  | 50-74-105                               | 52-76-107                               | 48-72-103   | 50-74-105                               | 52-76-107                               |
| Weight [kg] S3T (80-120)                 | N.A.   |   |   |   |   |   |
| Dimensions CPT (10-20) (WxDxH) [mm]      | Compact: 280x840x700   |   |   |   |   |   |
| Dimensions ACT (10-60) (WxDxH) [mm]      | Active: 380x850x1025   |   |   |   |   |   |
| Dimensions XTD (10-60) (WxDxH) [mm]      | Xtend: 440x840x1320  |   |   |   |   |   |
| Dimensions S3T 80-120 (WxDxH) [mm]       | N.A.   |   |   |   |   |   |
| Communications                           | UPS status led bar - Graphic touch screen display - 2 slots for communications interface<br>USB - RS232 - Contact interface with 5x opto insulated Input and 4x Output relays  |   |   |   |   |   |
| Ambient temperature for the UPS          | 0 °C - +40 °C  |   |   |   |   |   |
| Recommended temperature for battery life | +20 °C - +25 °C  |   |   |   |   |   |
| Range of relative humidity               | 5-95% non-condensing   |   |   |   |   |   |
| Colour                                   | RAL 7016   |   |   |   |   |   |
| Noise level at 1 m [dBA ±2] SMART ACTIVE | <40  |   |   |   |   |   |
| IP rating                                | IP20   |   |   |   |   |   |
| SMART ACTIVE efficiency                  | up to 99%  |   |   |   |   |   |
| Standards                                | European directives: LV 2014/35/EU low voltage Directive EMC 2014/30/EU electromagnetic compatibility<br>Directive Standards: Safety IEC EN 62040-1; EMC IEC EN 62040-2; RoHS compliant<br>Classification in accordance with IEC EN 62040-3 (Voltage Frequency Independent) VFI - SS - 111 |   |   |   |   |   |
| Moving the UPS                           | Castors / pallet jack  |   |   |   |   |   |

<sup>1</sup> For wider tolerance conditions apply.

<sup>BAT</sup> Also available with internal batteries.

| MODELS                                   | S3T<br>ACT-XTD 30 <sup>BAT</sup>   | S3T<br>ACT-XTD 40 <sup>BAT</sup> | S3T<br>ACT-XTD 60 <sup>BAT</sup> | S3T 80       | S3T 100 | S3T 120 |
|--|--|----------------------------------|----------------------------------|--------------|---------|---------|
| <b>INPUT</b>                             |  |                                  |                                  |              |         |         |
| Rated voltage [V]                        | 380 / 400 / 415 three-phase + N  |                                  |                                  |              |         |         |
| Rated frequency [Hz]                     | 50 / 60  |                                  |                                  |              |         |         |
| Voltage tolerance [V]                    | 400 ±20% @ full load <sup>1</sup>  |                                  |                                  |              |         |         |
| Frequency tolerance [Hz]                 | 40 - 72  |                                  |                                  |              |         |         |
| Power factor @ full load                 | 0.99   |                                  |                                  |              |         |         |
| Current distortion                       | THDI ≤3%   |                                  |                                  |              |         |         |
| <b>BYPASS</b>                            |  |                                  |                                  |              |         |         |
| Rated voltage [V]                        | 380 / 400 / 415 three-phase + N  |                                  |                                  |              |         |         |
| Number of phases                         | 3 + N  |                                  |                                  |              |         |         |
| Voltage tolerance (ph-N) [V]             | from 180 (adjustable 180-200) to 264 (adjustable 250-264) referring to neutral   |                                  |                                  |              |         |         |
| Rated frequency [Hz]                     | 50 or 60 (selectable)  |                                  |                                  |              |         |         |
| Frequency tolerance                      | ±5% (selectable)   |                                  |                                  |              |         |         |
| Bypass overload                          | 110% infinite, 125% for 60 min, 150% for 10 min  |                                  |                                  |              |         |         |
| <b>OUTPUT</b>                            |  |                                  |                                  |              |         |         |
| Nominal power [kVA]                      | 30   | 40                               | 60                               | 80           | 100     | 120     |
| Active power [kW]                        | 30   | 40                               | 60                               | 80           | 100     | 120     |
| Power factor                             | 1 up to 40 °C  |                                  |                                  |              |         |         |
| Number of phases                         | 3 + N  |                                  |                                  |              |         |         |
| Rated voltage [V]                        | 380 <sup>1</sup> / 400 / 415 three-phase + N (selectable)  |                                  |                                  |              |         |         |
| Rated frequency [Hz]                     | 50 or 60   |                                  |                                  |              |         |         |
| Frequency stability on battery operation | 0.01%  |                                  |                                  |              |         |         |
| Voltage stability                        | ±1%  |                                  |                                  |              |         |         |
| Dynamic stability                        | EN 62040-3 class performance 1 non-linear load   |                                  |                                  |              |         |         |
| Voltage distortion                       | <1% with resistive linear load / ≤1.5% with non-linear load  |                                  |                                  |              |         |         |
| <b>BATTERIES</b>                         |  |                                  |                                  |              |         |         |
| Type                                     | VRLA AGM/GEL/NiCd/Li-ion/SuperCaps   |                                  |                                  |              |         |         |
| Recharging method                        | One level, Two level, Cyclic recharge (selectable)   |                                  |                                  |              |         |         |
| <b>OVERALL SPECIFICATIONS</b>            |  |                                  |                                  |              |         |         |
| Weight without batteries [kg]            |  |                                  |                                  |              |         |         |
| CPT - ACT - XTD (10-60)                  | N.A.-78-112  | N.A.-82-116                      | N.A.-87-130                      |              | N.A.    |         |
| Weight [kg] S3T (80-120)                 | N.A.   |                                  |                                  | 172          | 180     | 198     |
| Dimensions CPT (10-20) (WxDxH) [mm]      | N.A.   |                                  |                                  |              |         |         |
| Dimensions ACT (10-60) (WxDxH) [mm]      | Active: 380x850x1025   |                                  |                                  | N.A.         |         |         |
| Dimensions XTD (10-60) (WxDxH) [mm]      | Xtend: 440x840x1320  |                                  |                                  | N.A.         |         |         |
| Dimensions S3T 80-120 (WxDxH) [mm]       | N.A.   |                                  |                                  | 500x830x1600 |         |         |
| Communications                           | UPS status led bar - Graphic touch screen display - 2 slots for communications interface<br>USB - RS232 - Contact interface with 5x opto insulated Input and 4x Output relays  |                                  |                                  |              |         |         |
| Ambient temperature for the UPS          | 0 °C - +40 °C  |                                  |                                  |              |         |         |
| Recommended temperature for battery life | +20 °C - +25 °C  |                                  |                                  |              |         |         |
| Range of relative humidity               | 5-95% non-condensing   |                                  |                                  |              |         |         |
| Colour                                   | RAL 7016   |                                  |                                  |              |         |         |
| Noise level at 1 m [dBA ±2] SMART ACTIVE | <40  |                                  | <50                              |              | <55     |         |
| IP rating                                | IP20   |                                  |                                  |              |         |         |
| SMART ACTIVE efficiency                  | up to 99%  |                                  |                                  |              |         |         |
| Standards                                | European directives: LV 2014/35/EU low voltage Directive EMC 2014/30/EU electromagnetic compatibility<br>Directive Standards: Safety IEC EN 62040-1; EMC IEC EN 62040-2; RoHS compliant<br>Classification in accordance with IEC EN 62040-3 (Voltage Frequency Independent) VFI - SS - 111 |                                  |                                  |              |         |         |
| Moving the UPS                           | Castors / pallet jack  |                                  |                                  |              |         |         |

<sup>1</sup> For wider tolerance conditions apply.

<sup>BAT</sup> Also available with internal batteries.

Note: S3T ACT 60 model is without internal batteries.







# Multi Sentry



DATACENTER



E-MEDICAL



EMERGENCY



INDUSTRY



TRANSPORT

**3:3** 160-200 kVA/kW



ONLINE



Tower



Energy Share



Service 1st start



SmartGrid ready



Supercaps UPS



USB plug



## HIGHLIGHTS

- **Range 160-200 kVA**
- **High efficiency up to 96.2%**
- **Zero impact**
- **Flexibility of use**
- **Advanced communications**

The Multi Sentry series is ideal for protecting Data Centers and telecommunications systems, IT networks and critical systems in general, where the risks connected with poor energy supply can compromise the continuity of activities and services. The Multi Sentry series is available in 160-200 kVA models with three-phase input and output and ON LINE double conversion technology in accordance with VFI-SS-111 classification (as set out in standard IEC EN 62040-3). Multi Sentry is designed and built using state-of-the-art technology and components. It has a fully controlled IGBT rectifier to minimise the impact on the grid. It is controlled by a DSP (Digital Signal Processor) microprocessor, to provide maximum protection to the powered loads

with no impact on downstream systems and optimised energy savings.

### ZERO IMPACT SOURCE

Multi Sentry solves installation problems in systems where the power supply has limited power available, where the UPS is supported by a generator or where there are compatibility problems with loads that generate harmonic currents; Multi Sentry has a zero impact on its power source, whether this is the mains power supply or a generator:

- Input current distortion up to <2.5%;
- Input power factor 0.99;
- Power walk-in function that ensures progressive rectifier start up;
- Start up delay function, to restart the rectifiers when mains power is restored



if there are several UPS in the system. In addition, Multi Sentry plays a filtering and power factor correction role in the power network upstream of the UPS, as it eliminates harmonic components and reactive power generated by the power utilities.

**HIGH EFFICIENCY**

State-of-the-art three-level NPC inverters are used across the power range (160-200 kVA) to achieve an operating efficiency of 96.2%. This technology halves (50%) the energy dissipated in a year by traditional UPS, with an efficiency level of 92%. Its exceptional performance makes it possible to recover the capital investment cost in less than three years of operation.

**BATTERY CARE SYSTEM**

Proper battery care is critical to ensuring correct UPS operation in emergency conditions. The Riello UPS battery care system consists of a series of features and capabilities to optimise battery management and obtain the best performance and operating life possible. Battery recharging: Multi Sentry is suitable for use with hermetically sealed lead-acid (VRLA), AGM and GEL batteries and Open Vent and Nickel Cadmium batteries. Depending on the battery type, different charging methods are available:

- One-level voltage recharge, typically used for widely available VRLA AGM batteries;
- Two-level voltage recharge according to IU specification;
- Charge blocking system to reduce electrolyte consumption and lengthen the life of VRLA batteries.

Recharge voltage compensation based on temperature in order to prevent excessive battery charges or overheating.

Battery tests to diagnose in advance any reduction in performance or problems with the batteries.

Deep discharge protection: during extended low-load discharges, the end-of-discharge voltage is increased - as recommended by battery manufacturers - to prevent damage or reduced battery performance.

Ripple current: recharge ripple current (residual AC component) is one of the main causes of reduced reliability and battery life.

Using a high frequency battery charger, Multi Sentry reduces this value to negligible levels, prolonging battery life and maintaining high performance over a long period of time. Wide voltage range: the rectifier is designed to operate within

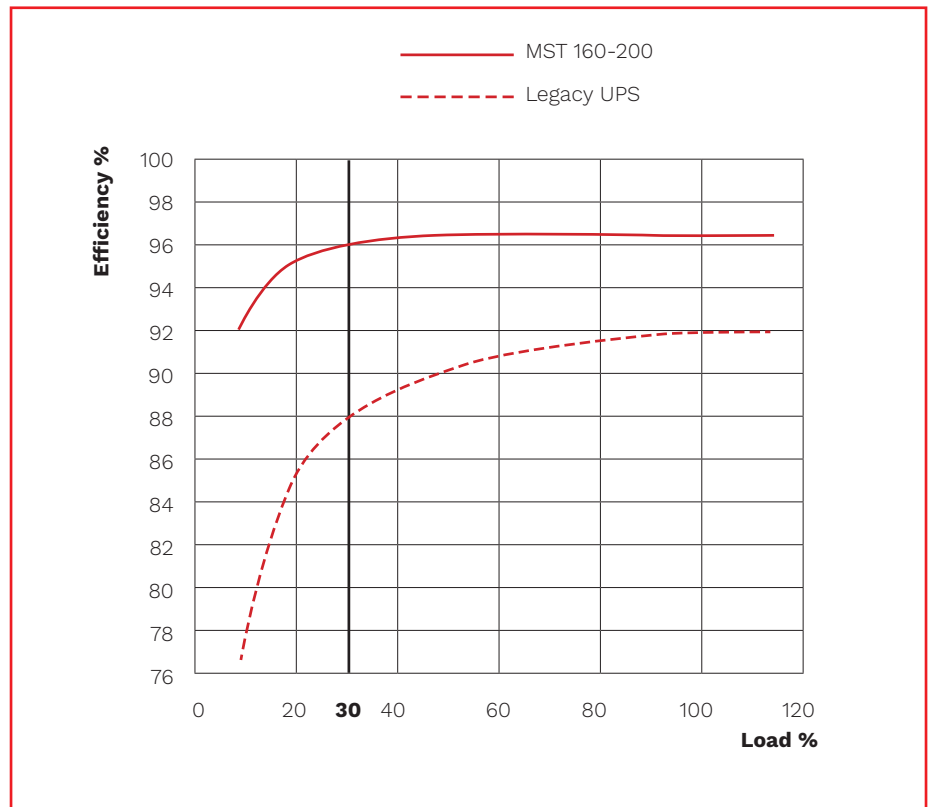

a wide input voltage range (up to -40% at half load), reducing the need for battery discharge and thus helping to extend battery life.

**MAXIMUM RELIABILITY AND AVAILABILITY**

Distributed parallel configuration of up to 8 units per redundant (N+1) or power parallel system. The UPS continue to operate in parallel even if the connection cable is interrupted (Closed Loop).

**LOW RUNNING COSTS**

A combination of advanced technology high performance components allows Multi Sentry to provide exceptional performance and efficiency:

- The type of input stage (IGBT rectifier) ensures an input power factor close to 1 with low current distortion, avoiding the need for bulky and expensive filters;
- Unity output power factor for MST 160-200 make it suitable to any Data Center application ensuring full power availability no matter what the utilities power factor range (typically from 0.9 lagging to 0.9 leading);



- More active power than a traditional UPS, guaranteeing a greater margin when sizing UPS for potential future load increases;
- Smart ventilation principle on MST 160-200 manages the number of operating fans and their speed according to room temperature and load level. This preserves the life span of the fans and at the same time we reduce noise level and overall power consumption for unnecessary UPS ventilation.

### FLEXIBILITY

With its flexible configuration, performance, accessories and options, Multi Sentry is suitable for use in a wide range of applications:

- Suitable for powering capacitive loads, such as blade servers, without any reduction in active power from 0.9 lead to 0.9 lag;
- ON LINE, ECO, SMART ACTIVE and STANDBY OFF operating Modes - compatible with centralised power systems (CPSS) applications;
- Frequency Converter Mode;
- Configurable EnergyShare sockets (as standard) to preserve runtime for the most critical loads or to be activated only when mains power fails;
- Cold Start to switch on the UPS even when there is no mains power present;
- Optional temperature sensor for external battery cabinets, to assist recharge voltage compensation;
- High power battery chargers to optimise charge time in the event of long runtimes;
- Optional dual input mains power supply;
- Isolation transformers for modifying the neutral earthing (separate power sources), or for galvanic isolation between the input and output;
- Different sized battery cabinets and capacities, for extended runtimes;
- MST 160-200 could be equipped with a side mounted top entry cabinet to arrange UPS cabling from the top.

### ADVANCED COMMUNICATIONS

Multi Sentry is equipped with a backlit graphic display (240x128 pixels) providing

UPS information, measurements, operating states and alarms in different languages. It can also display waveforms and voltage/current forms.

The default screen displays UPS status, graphically indicating the status of the various assemblies (rectifier, batteries, inverter, bypass).

- Advanced multi-platform communications for all operating systems and network environments: PowerShield<sup>3</sup> monitoring and shutdown software included for Windows operating systems 11, 10, 8, Hyper-V, Server 2022, 2019, 2016 and previous versions, Windows Server Virtualization Hyper-V, macOS, Linux, Citrix XenServer and other Unix operating systems;
- Compatible with VMware infrastructures to perform graceful shutdown of hosts and clusters; to perform Vmotion and prioritised shutdown of VM thanks to NetMan 208 Network card;
- Compatible with Nutanix and Syneto infrastructures to perform graceful shutdown of hosts; to perform prioritised shutdown of VM thanks to NetMan 208 Network card;
- Compatible with RielloConnect (remote monitoring service);
- RS232 port and USB ports;
- 3 slots for the installation of optional communications accessories such as network adapters, potential free contacts, etc.;
- R.E.P.O. Remote Emergency Power Off for switching off the UPS via a remote emergency button;
- Input for the connection of the auxiliary contact of an external manual bypass;
- Input for synchronisation from an external source;
- Graphic display panel for remote connection.

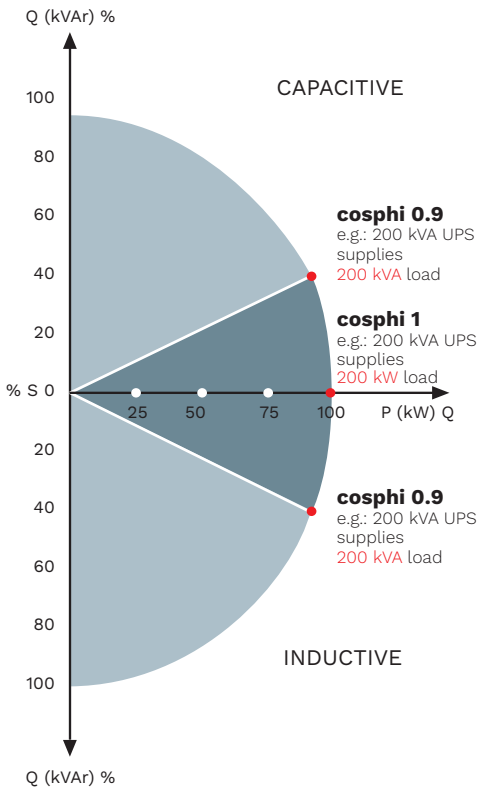

Multi Sentry MST 160-200.



Multi Sentry MST 160-200 with top cable entry.

## OPTIONS

### SOFTWARE

PowerShield<sup>3</sup>  
PowerNetGuard

### ACCESSORIES

NETMAN 208  
MULTICOM 302  
MULTICOM 352  
MULTICOM 372  
MULTICOM 384

MULTICOM 411  
MULTICOM 421  
MULTI I/O  
MULTIPANEL  
MBB 400 A 4P

### PRODUCT ACCESSORIES

Battery temperature sensor  
Parallel Kit  
Powerful battery charger

Programmable relay board  
MULTICOM 392  
IP rating IP30/IP31  
Top cable entry  
Eyebolts kit

## BATTERY CABINET

### MODELS

**BTC 1900 480V BB V6 3T**  
**BTC 1900 480V BB V7 3T**  
**BTC 1900 480V BB V8 3T**  
**BTC 1900 480V BB V9 3T**  
**BTC 1900 480V AB V9 3T**

UPS MODELS

up to 200 kVA<sup>1</sup>

860x800x1900

Dimensions WxDxH [mm]

*BTC 1900 480V BB V6 3T*  
*BTC 1900 480V BB V7 3T*  
*Not available for MST 160-200*  
*(when connected individually)*

<sup>1</sup>According with battery cabinet fuse associated.

## DETAILS

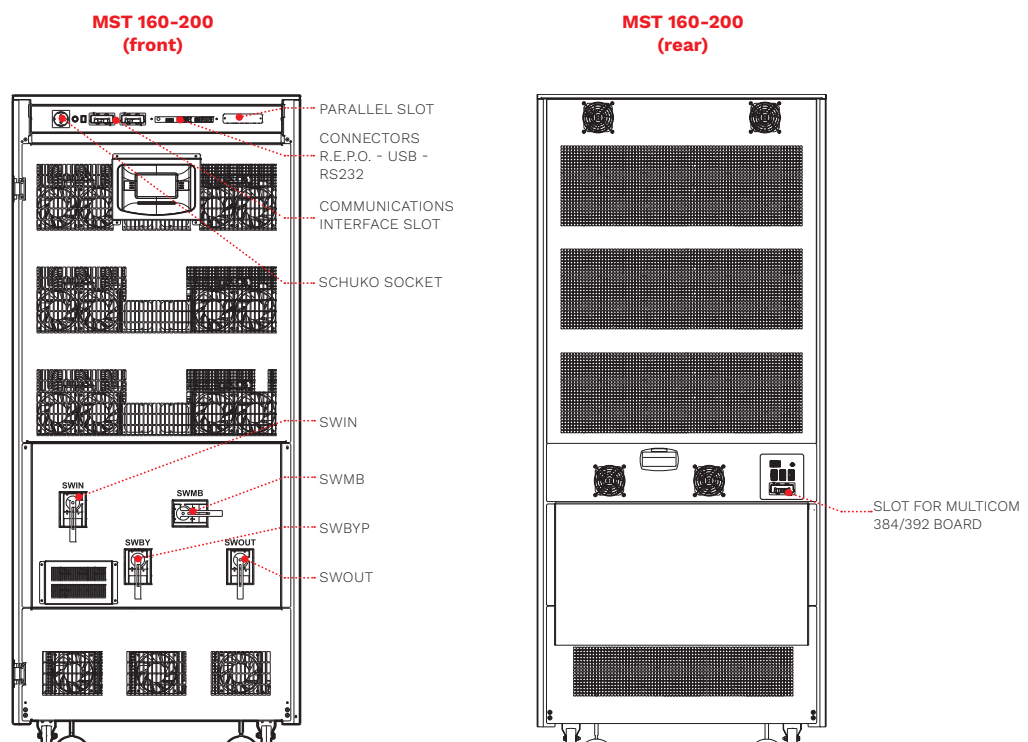

| MODELS  | MST 160  | MST 200    |
|---|--|------------|
| <b>INPUT</b>  |  |            |
| Rated voltage [V]                                   | 380 / 400 / 415 three-phase + N  |            |
| Rated frequency [Hz]                                | 50 / 60  |            |
| Voltage tolerance [V]                               | 400 ±20% @ full load <sup>1</sup>  |            |
| Frequency tolerance [Hz]                            | 40 - 72  |            |
| Power factor @ full load                            | 0.99   |            |
| Current distortion                                  | THDI ≤3%   | THDI ≤2.5% |
| <b>BYPASS</b>                                       |  |            |
| Rated voltage [V]                                   | 380 / 400 / 415 three-phase + N  |            |
| Number of phases                                    | 3 + N  |            |
| Voltage tolerance (ph-N) [V]                        | 180 / 264 (selectable)   |            |
| Rated frequency [Hz]                                | 50 or 60 (selectable)  |            |
| Frequency tolerance                                 | ±5% (selectable)   |            |
| Bypass overload                                     | 125% for 60 min, 150% for 10 min   |            |
| <b>OUTPUT</b>                                       |  |            |
| Nominal power [kVA]                                 | 160  | 200        |
| Active power [kW]                                   | 160  | 200        |
| Power factor  | 1  |            |
| Number of phases                                    | 3 + N  |            |
| Rated voltage [V]                                   | 380 / 400 / 415 three-phase + N (selectable)   |            |
| Static variation                                    | ±1%  |            |
| Dynamic variation                                   | ±3%  |            |
| Crest factor [I <sub>peak</sub> /I <sub>rms</sub> ] | 3:1  |            |
| Voltage distortion                                  | ≤1% with resistive linear load / ≤3% with non-linear load  |            |
| Frequency [Hz]                                      | 50 / 60  |            |
| Frequency stability during battery operation        | 0.01%  |            |
| <b>BATTERIES</b>                                    |  |            |
| Type  | VRLA AGM/GEL/NiCd/Li-ion/Supercaps   |            |
| Recharge time                                       | 6 h  |            |
| <b>OVERALL SPECIFICATIONS</b>                       |  |            |
| Weight without batteries [kg]                       | 450  | 460        |
| Dimensions (WxDxH) [mm]                             | 840x1035x1900  |            |
| Communications                                      | 3 slots for communications interface / USB / RS232   |            |
| Ambient temperature for the UPS                     | 0 °C - +40 °C  |            |
| Recommended temperature for battery life            | +20 °C - +25 °C  |            |
| Range of relative humidity                          | 5-95% non-condensing   |            |
| Colour  | RAL 7016   |            |
| Noise level at 1 m [dBA±2] (SMART ACTIVE )          | <50  |            |
| IP rating   | IP20   |            |
| SMART ACTIVE efficiency                             | up to 99%  |            |
| Standards   | European directives: LV 2014/35/EU low voltage Directive EMC 2014/30/EU electromagnetic compatibility Directive Standards: Safety IEC EN 62040-1; EMC IEC EN 62040-2; RoHS compliant Classification in accordance with IEC EN 62040-3 (Voltage Frequency Independent) VFI - SS - 111 |            |
| Moving the UPS                                      | castors  |            |

<sup>1</sup> For wider tolerance conditions apply.





# NextEnergy



DATACENTER



E-MEDICAL



EMERGENCY



INDUSTRY



TRANSPORT

**3:3** 250-800 kVA/kW



ONLINE



Lithium compatible



Tower



Service 1st start



SmartGrid ready



Supercaps UPS



USB plug



## HIGHLIGHTS

- **Efficiency up to 97% in double conversion**
- **kW = kVA (pf 1) up to 40 °C**
- **Transformer-free UPS**
- **Full front access, back-to-back installation**
- **ACTIVE ECO Mode (active filter)**
- **Colour LCD Touch Screen**
- **Peak shaving**

**The Riello UPS NextEnergy is the latest UPS series designed for mission critical applications as Data Centers, communication networks, commercial and industrial installations.**

The three-phase UPS offers transformer-free double conversion technology VFI SS 111, with integrated IGBT three-level design. NextEnergy is designed to offer unsurpassed performance and meets the power requirements of tomorrow. NextEnergy is fully scalable to evolve with growing business demands. It offers the highest level of power availability as well as reduced TCO, minimum energy consumption and CO<sub>2</sub> emissions. Its unity power factor and easy system upgrading make it the ideal solution for the business continuity of any IT application. Thanks to

its fault tolerant architecture, concurrent maintainability and hot scalability, NextEnergy guarantees continuous operation and premium protection for your customers' business.

### **ZERO IMPACT SOURCE AND PEAK DEMAND MANAGEMENT**

NextEnergy is designed with the latest technology to prevent disturbances on the mains and is able to "clean" the power from e.g. harmonics generated by non-linear loads. The input AC/DC converter is based on the IGBT rectifier design using the latest 3-level technology. The key features are:

- Input current distortion <3%;
- Input power factor 0.99;
- Power walk-in function that ensures





progressive rectifier start up;

- start up delay function, to restart the rectifiers when mains power is restored.

**PEAK SHAVING FUNCTION**

Thanks to the possibility to set the maximum input power (kW or kVA), NextEnergy can be installed into AC supply systems with limited power availability such as a diesel generator or contractually reduced power sources and then supply the additional power required using the batteries (Peak Shaving function). NextEnergy offers 3 peak shaving operation modes:

- **Static:** the NXE input power is programmed at commissioning time;
- **User Remote control:** the user decides when reduce the input power of the UPS via commands;
- **Dynamic:** the peak shaving works automatically as per the site conditions.

**OUTSTANDING PERFORMANCE**

- The latest technology of NextEnergy and the careful selection of high-quality components help to achieve first-class performance such as unity power factor (kVA = kW) and the capability to supply capacitive loads, which are very common in most Data Centers, without any power derating up to 40 °C;

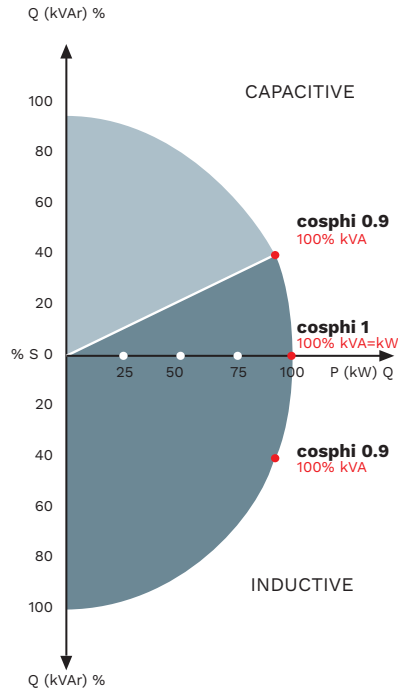

- Outstanding system efficiency up to 97% in ON LINE Mode, increasing to 98.5% in ACTIVE ECO Mode and 99% in ECO Mode;
- Specific attention has been given to the ventilation system to ensure the best operational level and long lifetime. This is possible thanks to the automatic

fan speed control which constantly adjusts to the specific load level, the fan failure alarm and the fan redundancy architecture;

- NextEnergy is capable to work at very high ambient temperature, over to 40 °C. The UPS is designed with consistent safety margins granting operation up to 55 °C (condition apply).

**SMART BATTERY MANAGEMENT (SBM)**

The battery system is the energy reserve in every UPS installation and consequently a fundamental asset in every power continuity plan to ensures the correct operation in case of mains failure. This asset must be carefully managed. NextEnergy includes all the latest features supervise, to prolong the battery life and keep the battery working efficiently, as well as advising users about any potential problem.

In addition, NextEnergy allows flexibility on the number of battery cells to choose the most cost-effective solution for the required backup time. The battery charging and discharging is assured by the STEP-UP/STEP-DOWN converter which means that when the batteries are charged and the mains is available, the battery is no longer connected to the supply. This means the ripple current is practically zero which leads to a significant improvement in battery life.

**FLEXIBLE BATTERY STORAGE**

NextEnergy offers complete freedom to choose the best energy storage device for each type of installation or application. The variety of the charging methods in conjunction with the flexibility offered by the power electronics and the decades of field experience allow to use NextEnergy in conjunction with all the most common type of battery technologies available in the market like VRLA, AGM, GEL, NiCd but also with other type of energy accumulators as Li-ion Battery solutions. For short back-up time from some seconds up to a couple of minutes NextEnergy is released to work also with SuperCapacitors, a very reliable technology for such applications.

**CAPACITY AND INSTALLATION FLEXIBILITY**

NextEnergy is designed to guarantee maximum cost savings (TCO) and flexibility of installation to adapt to every need and situation.

- The UPS ventilation is from the front of the cabinet to the top so no additional rear clearance is required, allowing vast

range of layouts configurations, whether it be a straight row, back to wall or back-to-back, the system easily adapts to available floor space;

- The small footprint of the cabinet and complete front access for all maintenance activities, ensures maximum space for installation and service;
- NextEnergy includes top and bottom cable entry (on NXE 250, NXE 500 and NXE 600 top on option);
- Operation without Neutral: NextEnergy can work with (4 wire) or without (3 wire) the neutral line connection (see below picture).



4-wire (L1-L2-L3-N) installation

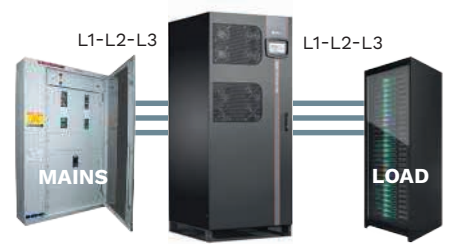

3-wire (L1-L2-L3) installation

This is an important feature to reduce the TCO of the distribution system, where the neutral line cable is not distributed - savings investment - and the neutral is created by an isolation transformer close to the load. This is a typical infrastructure solution adopted by modern Data Center or for installations where the neutral is not used at all, allowing not only reduced cost for the distribution arrangements but also effortless replacement of legacy equipments.

**MAXIMUM RELIABILITY AND AVAILABILITY**

The NextEnergy architecture and features deliver significant cost savings thanks to an easy adapting to new or existing installations without impacting power infrastructure. This is possible through scalability, granting minimised initial investment (CAPEX), adding power cores

## PEAK SHAVING FUNCTION

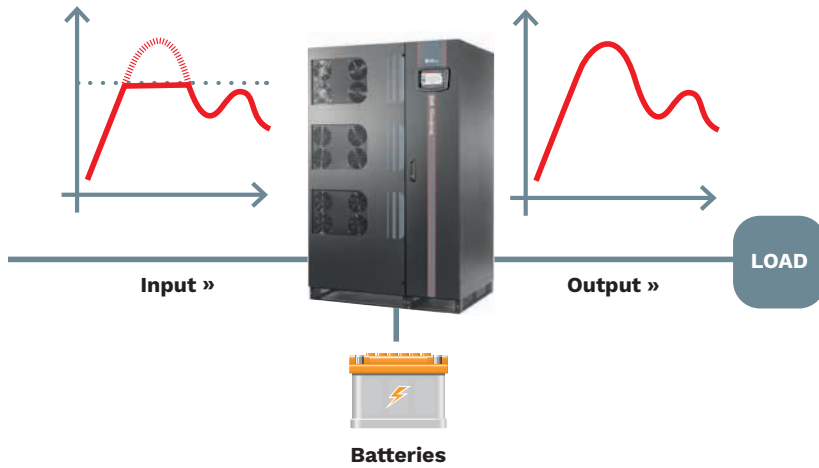

## FLEXIBILITY OF POSITIONING

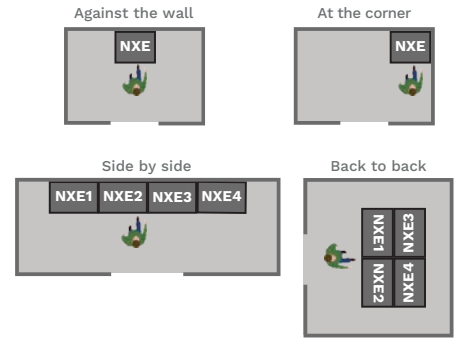

## EFFICIENCY CONTROL MODE (ECM)

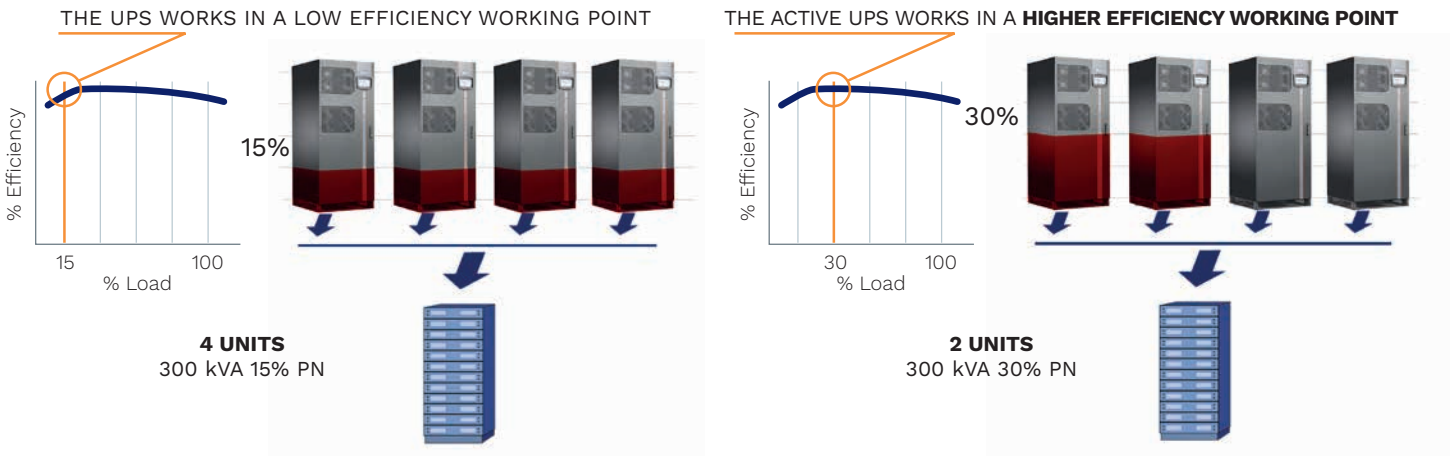

## OPERATION MODES

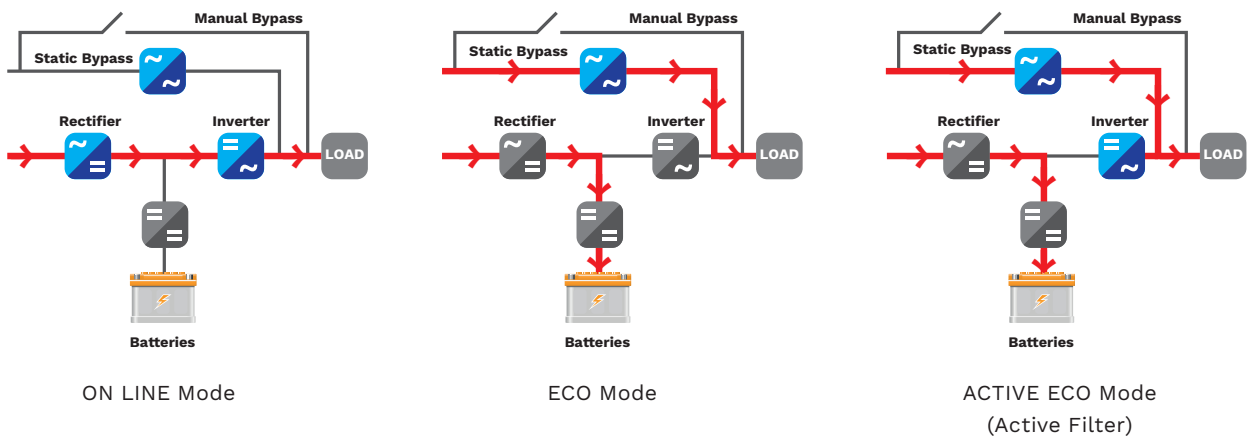

as business demands grow:

• **Parallel configuration up to 8 units**

NextEnergy UPS can be connected in parallel with up to 8 units to increase the capacity or add redundancy (N+1). Parallel configuration with common or separated battery is possible.

• **EFFICIENCY CONTROL Mode (ECM)**

Considering that a typical UPS load can vary from 20% to 80%, the ECM function optimises the operating efficiency of a parallel UPS configuration according to the power absorbed by the load: in case of low load, it sets some UPS in “freeze” mode, ensuring redundancy and a working point of the “live” UPS in the higher efficiency working point, during all load conditions (see below picture).

• **Hot System Expansion (HSE)** allows the

addition of further UPS into an existing system, without the need to switch off the operational units or switch to bypass.

**OPERATION MODES**

The UPS can operate in many Operation Modes, in order to grant always the maximum level of protection and maximum level of efficiency, based on mains quality and load type.

**ON LINE MODE**

It provides the highest level of power conditioning and protects the load from all electrical network disturbance in terms of voltage and frequency. The overall AC/AC efficiency is up to 97%.

**ECO MODE**

The load is normally powered from the bypass line while the rectifier keeps the battery charged. When the mains exceeds the limits the load is automatically transferred in ON LINE Mode in approx. 2 ms The efficiency is more than 99%.

**ACTIVE ECO MODE**

In this mode the NXE works as Active Filter: the bypass line is the main source and supplies the active power while the inverter only provides the reactive part of the load. This ensures that the UPS input power factor remains close to unity, regardless of the load power factor. In addition, the inverter operation reduces significantly the harmonic content (THDi) applied to the mains supply. In case of mains failure the transfer time on Inverter is approximately 0 (classified VFD SS 11). Power factor correction plays an active role in reducing the installation’s TCO: it means reduction of Joule losses and voltage drop, for an optimum sizing of electrical equipment such as power

transformers, cables, busbars, switch and protection devices. The electric distribution is more efficient and stable. Also the current distortion (harmonics) generated by non-linear loads such as inverters, computers, drives and so on causes several problems in an electric system. It is important to reduce it. ACTIVE ECO Mode combines high level of availability with important CAPEX and OPEX reduction. The efficiency is more than 98.5%



**Higher availability vs ECO mode**

**Highest level of efficiency for an excellent cost savings**

**No need for expensive PFC**  
(POWER FACTOR CORRECTION SYSTEMS)

**Avoid upstream problems related to high THDi**

**SMART ACTIVE MODE**

NextEnergy automatically defines whether to operate in ON LINE and/or ECO Mode, this is selected by monitoring the performances of the bypass supply, if this remains stable for a defined period the system stays in ECO Mode otherwise in ON LINE Mode. In SMART ACTIVE operating mode, the NextEnergy is able to combine the superior availability of a double conversion (ON LINE) operating mode with the excellent energy cost savings of a high efficiency mode (ECO Mode) for a reduced total cost of ownership.

**SMART CAPACITY TEST (SCT)**

Thanks to the Smart Capacity Test (SCT) functionality (Load Test mode) the system can be tested onsite during the commissioning, before it is connected to the real load, without using costly temporary loads, cabling and breakers and without wasting energy from the power network. In this condition the UPS output supplies energy to the input in re-circulating mode. In this mode NextEnergy is low consuming, just the energy due the internal losses.

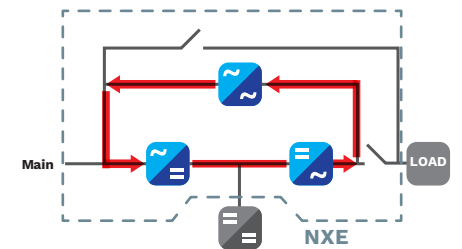

*No need to use costly temporary loads, cabling and breakers. No waste of energy.*

**COLOUR LCD TOUCH SCREEN**

Users can benefit from an advanced operation and supervision systems developed specifically for IT personnel, facilities managers and service engineers to ensure that the UPS setup, control and monitoring is easy. NextEnergy is equipped with an LCD touch screen 7” graphic display (800x480 pixels) providing in a user-friendly graphical interface the UPS information: line mimic diagram showing system status, dashboard style indicators for all the system values and conditions, voltage and current waveforms, operating states and alarms. The panel is used for configuration and setting the parameters of the UPS with high security access thanks to 3 separate password levels for users and service engineers.

The main features are:

- High security access with separate password levels for users, technician and service engineers;
- User-friendly graphical interface;
- Single-line mimic diagram showing system status;
- Contemporary dashboard-style indicators for major system values and conditions;
- Automatic charting display for logged power and environmental data.



### ADVANCED COMMUNICATION AND SUPERVISION

NextEnergy offers wide communication and supervision tools and interface granting an easy integration into any building management system (BMS) and Data Center infrastructure (DCIM).

- PowerShield<sup>3</sup> monitoring and shutdown software for Windows operating systems 11, 10, 8, Server 2022, 2019, 2016 and previous versions, Windows Server Virtualization Hyper-V, macOS, Linux, Citrix XenServer and other Unix operating systems;
- RielloConnect for remote monitoring service;
- 2 slots suitable for the installation of the communication accessories such as network adapters and BMS interface;
- Ethernet and USB ports;
- Relay cards with customised alarms and commands.

More and more applications require the use of lithium batteries that are always paired with Battery Monitoring Systems: for this reason, NextEnergy series offers an advanced interfacing system to easily dialogue with this kind of systems.

# NextEnergy

# DETAILS

**NXE 250**  
(open front)

**NXE 300**  
(open front)

**NXE 400**  
(open front)

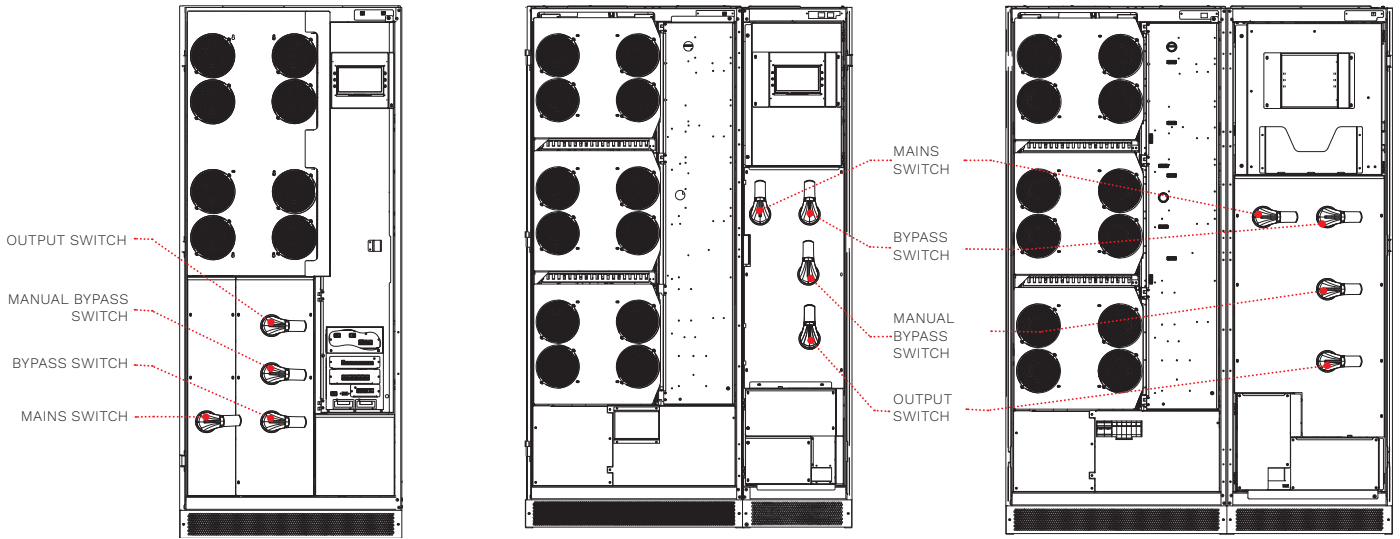

**NXE 500**  
(open front)

**NXE 600**  
(open front)

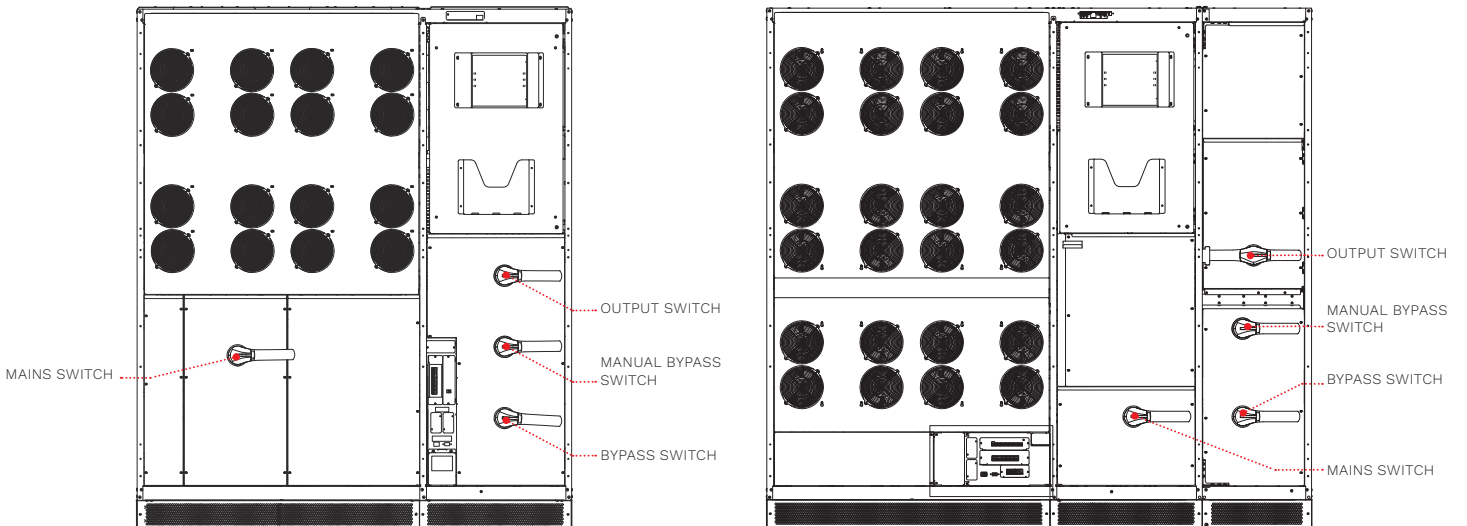

## DETAILS

**NXE 800**  
(open front)

**NXE 800 2SW**  
(open front)

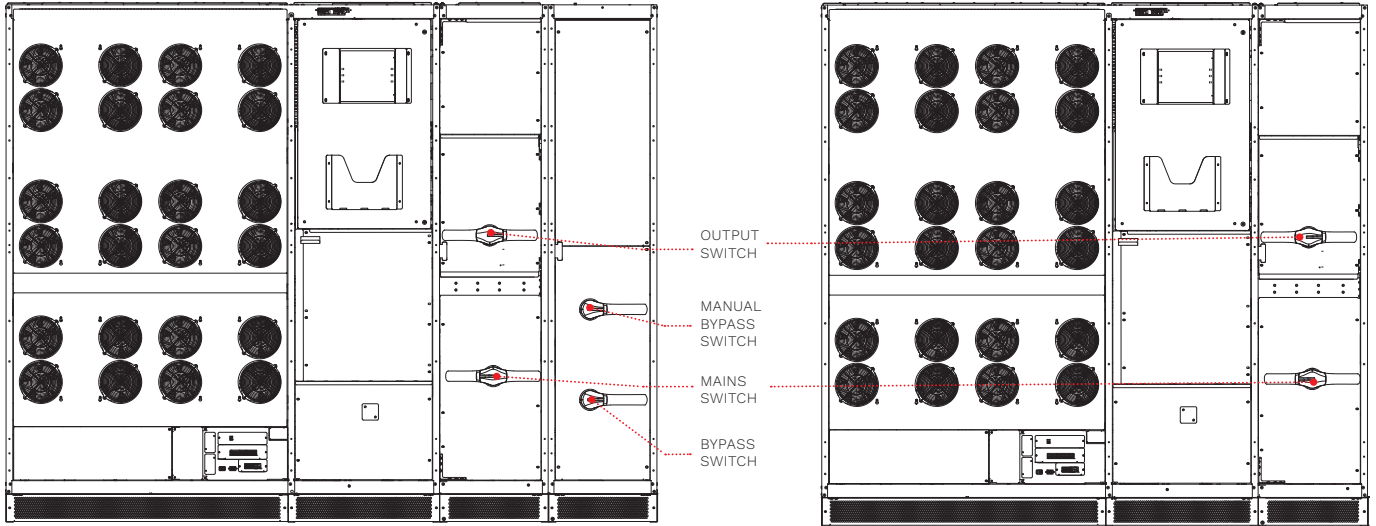

## DIMENSION

**NXE 250**

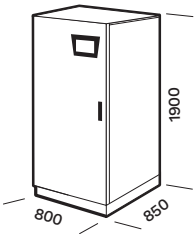

**NXE 300**

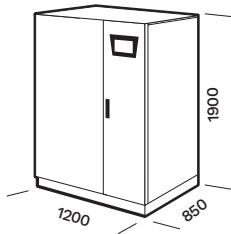

**NXE 400**

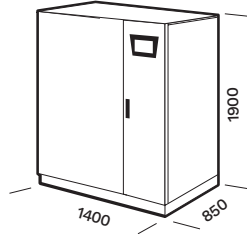

**NXE 500**

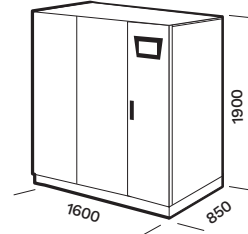

**NXE 600**  
**NXE 800 2SW**

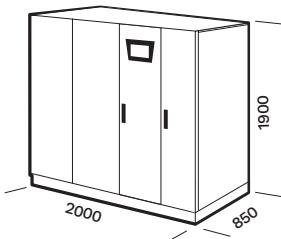

**NXE 800**

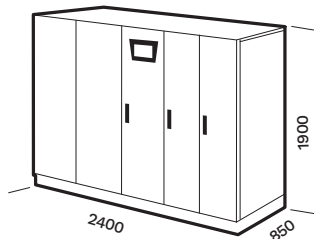

## OPTIONS

|                          |                                      |                |
|--------------------------|--------------------------------------|----------------|
| <b>SOFTWARE</b>          | MULTI I/O                            | Cold start     |
| PowerShield <sup>3</sup> | MULTI PANEL                          | Air filter kit |
| PowerNetGuard            |                                      | ENERGYMANAGER  |
| <b>ACCESSORIES</b>       | <b>PRODUCT ACCESSORIES</b>           |                |
| NETMAN 208               | Battery temperature sensor           |                |
| MULTICOM 302             | Isolation transformer                |                |
| MULTICOM 352             | Parallel kit                         |                |
| MULTICOM 411             | Synchronisation device (UGS)         |                |
| MULTICOM 421             | Hot connection device (PSJ)          |                |
|                          | IP21/IP31 versions, other on request |                |

## BATTERY CABINET

|               |   |
|---------------|---|
| <b>MODELS</b> | <b>BTC 1900 480V BB V6 3T</b><br><b>BTC 1900 480V BB V7 3T</b><br><b>BTC 1900 480V BB V8 3T</b><br><b>BTC 1900 480V BB V9 3T</b><br><b>BTC 1900 480V AB V9 3T</b> |
| UPS MODELS    | NXE 250-300-400-500-600-800   |

Dimensions [mm]

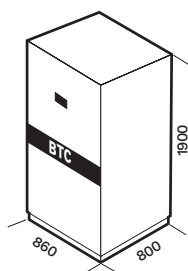

## THREE-PHASE ISOLATION TRANSFORMERS

| <b>MODELS</b>   | <b>TBX ISO 250 T Dzn0</b> | <b>TBX ISO 300 T Dzn0</b><br><b>TBX ISO 600 T Dzn0</b> |
|-----------------|---------------------------|--|
| UPS MODELS      | NXE 250                   | NXE 300-400-500-600                                    |
| Dimensions [mm] |                           |  |

Note: TBX ISO 800 T Dzn0 for NXE 800 available on request.

| MODELS  | NXE 250   | NXE 300   | NXE 400        |
|---|---|---|----------------|
| <b>INPUT</b>                                  |   |   |                |
| Rated voltage [V]                             | 380 / 400 / 415 three-phase   |   |                |
| Voltage tolerance [V]                         | 400 ±20% @ full load <sup>1</sup>   |   |                |
| Frequency tolerance [Hz]                      | 40 - 70   |   |                |
| Power factor                                  | 0.99  |   |                |
| THDI  | <3%   |   |                |
| Soft Start                                    | 0 - 100% in 120 s (selectable)  |   |                |
| Standard equipment provided                   | Backfeed protection, separate bypass line   |   |                |
| <b>BATTERIES</b>                              |   |   |                |
| Type  | VRLA AGM / GEL, NiCd, Supercaps, Li-ion   |   |                |
| Ripple current                                | Zero  |   |                |
| Recharge voltage compensation                 | -0.11% x V x °C   |   |                |
| <b>OUTPUT</b>                                 |   |   |                |
| Nominal Power [kVA]                           | 250   | 300   | 400            |
| Active Power [kW]                             | 250   | 300   | 400            |
| Number of phases                              | 3 + N   |   |                |
| Rated voltage [V]                             | 380 / 400 / 415 three-phase + N (selectable)  |   |                |
| Static Stability                              | ±1%   |   |                |
| Dynamic Stability                             | ±5% in 10 ms  |   |                |
| Voltage distortion                            | <1% with linear load/<3% with non-linear load   |   |                |
| Frequency stability on battery                | ± 0.05%   |   |                |
| Frequency [Hz]                                | 50 or 60 (selectable)   |   |                |
| Overload                                      | 110% for 60 min; 125% for 2 min;<br>150% for 20 s   | 110% for 60 min; 125% for 10 min;<br>150% for 1 min |                |
| <b>BYPASS</b>                                 |   |   |                |
| Rated voltage [V]                             | 380 / 400 / 415 three-phase + N   |   |                |
| Rated Frequency [Hz]                          | 50 or 60 (selectable)   |   |                |
| Frequency tolerance                           | ±2% (selectable from ±1% to ±5%)  |   |                |
| <b>OVERALL SPECIFICATIONS</b>                 |   |   |                |
| Weight [kg]                                   | 634   | 880   | 1100           |
| Dimension (WxDxH) [mm]                        | 800x850x1900  | 1200x850x1900                                       | 1400x850x1900  |
| Input cable                                   | Bottom  | Top and bottom                                      | Top and bottom |
| Remote signals                                | Volt-free contact (configurable)  |   |                |
| Remote controls                               | EPO, bypass battery charge block (configurable)   |   |                |
| Communications                                | USB + Dry contacts + 2 slots for communications interface   |   |                |
| Ambient temperature for the UPS               | 0 °C - +40 °C   |   |                |
| Recommended temperature for battery life      | +20 °C - +25 °C   |   |                |
| Range of relative humidity                    | 5-95% non-condensing  |   |                |
| Colour  | RAL 7016  |   |                |
| IP rating                                     | IP20 (other on request)   |   |                |
| Efficiency (AC-AC) ON LINE Mode               | up to 97%   |   |                |
| Standards                                     | European directives: LV 2014/35/EU low voltage Directive EMC 2014/30/EU electromagnetic compatibility Directive Standards: Safety IEC EN 62040-1; EMC IEC EN 62040-2; RoHS compliant Classification in accordance with IEC 62040-3 (Voltage frequency Independent) VFI - SS - 111 |   |                |
| Classification in accordance with IEC 62040-3 | (Voltage Frequency Independent) VFI - SS - 111  |   |                |
| Moving the UPS                                | Pallet jack   |   |                |

<sup>1</sup> For wider tolerance conditions apply.





| MODELS  | NXE 500   | NXE 600       | NXE 800 2SW  | NXE 800        |
|---|---|---------------|--|----------------|
| <b>INPUT</b>                                  |   |               |  |                |
| Rated voltage [V]                             | 380 / 400 / 415 three-phase   |               |  |                |
| Voltage tolerance [V]                         | 400 ±20% @ full load <sup>1</sup>   |               |  |                |
| Frequency tolerance [Hz]                      | 40 - 70   |               |  |                |
| Power factor                                  | 0.99  |               |  |                |
| THDI  | <3%   |               |  |                |
| Soft Start                                    | 0 - 100% in 120 s (selectable)  |               |  |                |
| Standard equipment provided                   | Backfeed protection, separate bypass line   |               |  |                |
| <b>BATTERIES</b>                              |   |               |  |                |
| Type  | VRLA AGM / GEL, NiCd, Supercaps, Li-ion   |               |  |                |
| Ripple current                                | Zero  |               |  |                |
| Recharge voltage compensation                 | -0.11% x V x °C   |               |  |                |
| <b>OUTPUT</b>                                 |   |               |  |                |
| Nominal Power [kVA]                           | 500   | 600           | 800  | 800            |
| Active Power [kW]                             | 500   | 600           | 800  | 800            |
| Number of phases                              | 3 + N   |               |  |                |
| Rated voltage [V]                             | 380 / 400 / 415 three-phase + N (selectable)  |               |  |                |
| Static Stability                              | ±1%   |               |  |                |
| Dynamic Stability                             | ±5% in 10 ms  |               |  |                |
| Voltage distortion                            | <1% with linear load/<3% with non-linear load   |               |  |                |
| Frequency stability on battery                | ± 0.05%   |               |  |                |
| Frequency [Hz]                                | 50 or 60 (selectable)   |               |  |                |
| Overload                                      | 110% for 60 min;<br>125% for 2 min;<br>150% for 20 s  |               | 110% for 60 min;<br>125% for 10 min;<br>150% for 1 min |                |
| <b>BYPASS</b>                                 |   |               |  |                |
| Rated voltage [V]                             | 380 / 400 / 415 three-phase + N   |               |  |                |
| Rated Frequency [Hz]                          | 50 or 60 (selectable)   |               |  |                |
| Frequency tolerance                           | ±2% (selectable from ±1% to ±5%)  |               |  |                |
| <b>OVERALL SPECIFICATIONS</b>                 |   |               |  |                |
| Weight [kg]                                   | 1300  | 1600          | 1800   | 1985           |
| Dimension (WxDxH) [mm]                        | 1600x850x1900   | 2000x850x1900 | 2000x850x1900  | 2400x850x1900  |
| Input cable                                   | Bottom  | Bottom        | Bottom   | Top and bottom |
| Remote signals                                | Volt-free contact (configurable)  |               |  |                |
| Remote controls                               | EPO, bypass battery charge block (configurable)   |               |  |                |
| Communications                                | USB + Dry contacts + 2 slots for communications interface   |               |  |                |
| Ambient temperature for the UPS               | 0 °C - +40 °C   |               |  |                |
| Recommended temperature for battery life      | +20 °C - +25 °C   |               |  |                |
| Range of relative humidity                    | 5-95% non-condensing  |               |  |                |
| Colour  | RAL 7016  |               |  |                |
| IP rating                                     | IP20 (other on request)   |               |  |                |
| Efficiency (AC-AC) – ON LINE Mode             | up to 97%   |               |  |                |
| Standards                                     | European directives: LV 2014/35/EU low voltage Directive EMC 2014/30/EU electromagnetic compatibility Directive Standards: Safety IEC EN 62040-1; EMC IEC EN 62040-2; RoHS compliant Classification in accordance with IEC 62040-3 (Voltage frequency Independent) VFI - SS - 111 |               |  |                |
| Classification in accordance with IEC 62040-3 | (Voltage Frequency Independent) VFI - SS - 111  |               |  |                |
| Moving the UPS                                | Pallet jack   |               |  |                |

<sup>1</sup> For wider tolerance conditions apply.

## NXE EMBEDDED PROTOCOLS

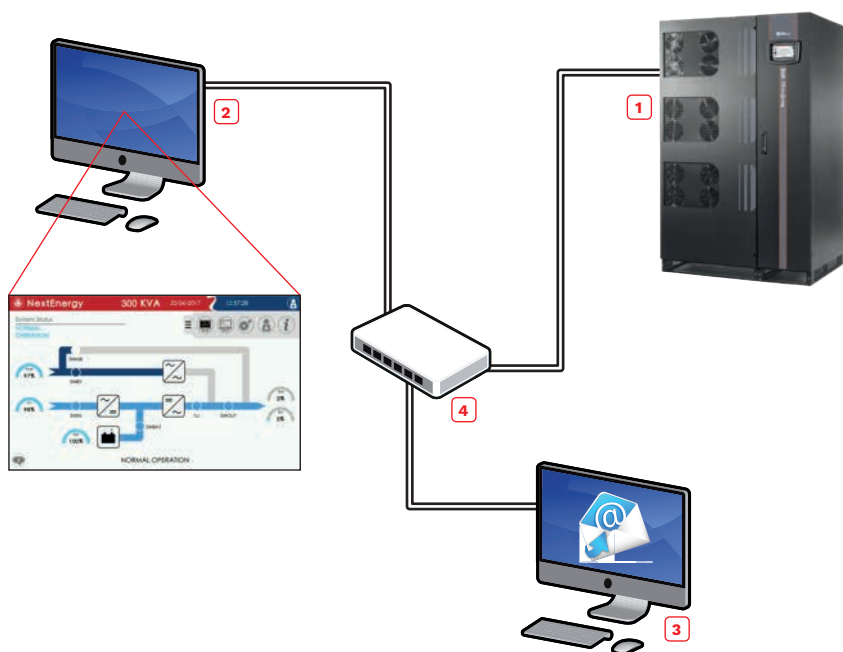

- 1 NextEnergy UPS
- 2 PowerShield<sup>2</sup>
- 3 Mail Server
- 4 Ethernet Switch
- == Ethernet

## NXE PROTOCOLS ADDING NETMAN 208 CARD

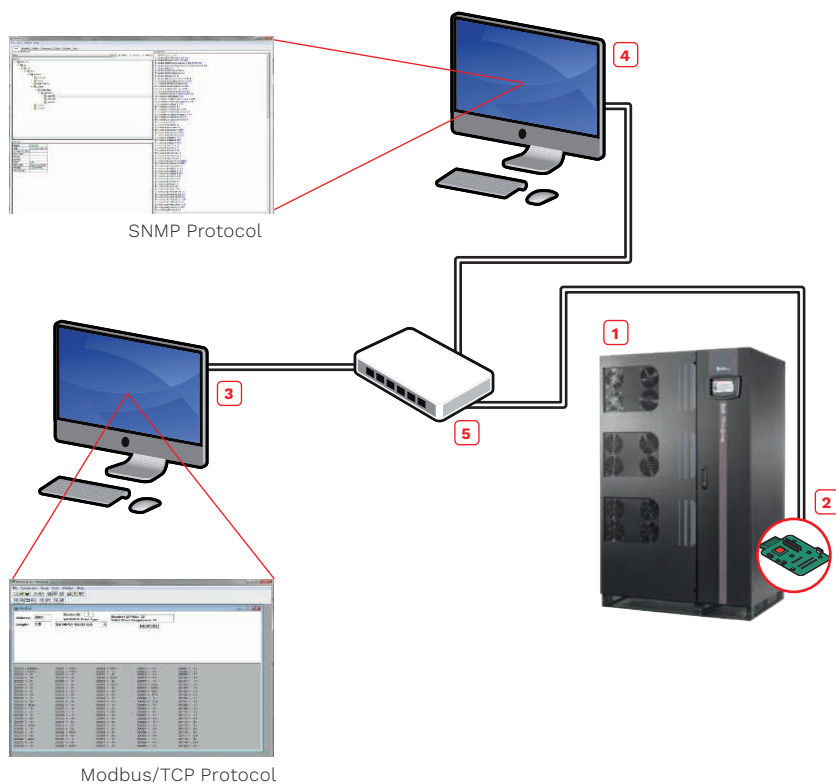

- 1 NextEnergy UPS
- 2 NetMan 208 board
- 3 Modbus/TCP Manager
- 4 SNMP Manager
- 5 Ethernet Switch
- == Ethernet





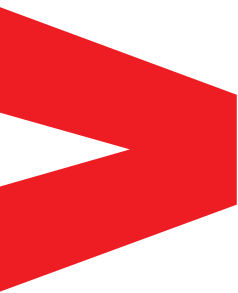

# Master MPS



DATACENTER



E-MEDICAL



EMERGENCY



INDUSTRY



TRANSPORT



ONLINE



Tower



Lithium compatible



Service 1st start



SmartGrid ready



Supercaps UPS

**3:1** 10-100 kVA  
**3:3** 10-200 kVA



## HIGHLIGHTS

- **EFFICIENCY CONTROL Mode (ECM)**
- **Robust and reliable**
- **Galvanic isolation**
- **High overload capacity**
- **Hot System Expansion (HSE)**

### TOTAL PROTECTION

The Master MPS series UPS provides maximum protection and power quality for mission critical loads, including data centers, industrial processes, telecommunications, security and electro-medical systems.

Master MPS is an ON LINE double conversion UPS classified as VFI-SS-111 (as set out by the IEC EN 62040-3 standard) with a transformer-based isolated inverter. The Master MPS range includes three-phase input and single-phase output versions from 10 to 100 kVA and three-phase input and output versions from 10 to 200 kVA. All versions are provided with a 6-pulse thyristor-based rectifier, with or without optional harmonic filters. A 12-pulse thyristor-based rectifier is

available on request for the 60 and 80 kVA three-phase output versions with or without optional harmonic filters.

### EASY SOURCE

Master MPS makes supplying the UPS from generator sets and MT/BT transformers simpler and more efficient, reducing power loss in the system and coils, correcting the power factor and eliminating current harmonics created by the loads supplied by the UPS.

In addition to this, the progressive rectifier start up (power walk-in) and the option to reduce battery charging currents, allow for a reduction in the input current uptake. This means less demand on the source, which is particularly useful when the source is a generator set.



## FLEXIBILITY

Master MPS is suitable for a wide range of applications including IT and the most demanding industrial environments. The UPS is suitable for powering capacitive and inductive loads. With a broad range of accessories and options, complex configurations and system architectures can be achieved to guarantee maximum power availability, as well as providing the option to add new UPS without interruption to existing installation.

## BATTERY CARE SYSTEM: MAXIMUM BATTERY CARE

Normally the batteries are kept charged by the rectifier; when mains power fails, the UPS uses this energy source to power the critical load. Proper battery care is therefore critical to ensure the correct UPS operation under emergency conditions. The Riello UPS battery care system consists of a series of functions designed to optimise battery management and achieve the best possible performance and operating life. Master MPS is also compatible with various battery technologies: open vented lead acid, VRLA AGM, Gel, NiCd, Supercaps and Lithium-ion.

## SPECIFIC SOLUTIONS

The UPS can be adapted to meet the most specific requirements. Contact our TEC team to discuss any specific solutions and options not listed in this catalogue.

## ADVANCED COMMUNICATIONS

- Compatible with RielloConnect platform for remote monitoring;
- Advanced multi-platform communications for all operating systems and network environments: PowerShield<sup>3</sup> monitoring and shutdown software included for Windows operating systems 11, 10, 8, Hyper-V, Server 2022, 2019, 2016 and previous versions, Windows Server Virtualization Hyper-V, macOS, Linux, Citrix XenServer and other Unix operating systems;
- Double RS232 serial;
- 2 slots for the installation of optional communications accessories such as network adapters, potential free contacts, etc.;
- R.E.P.O. Remote Emergency Power Off for switching off the UPS via a remote emergency button;
- Input for the connection of the auxiliary contact of an external manual bypass;
- Input for synchronisation from an external source;
- Remote graphic display panel.

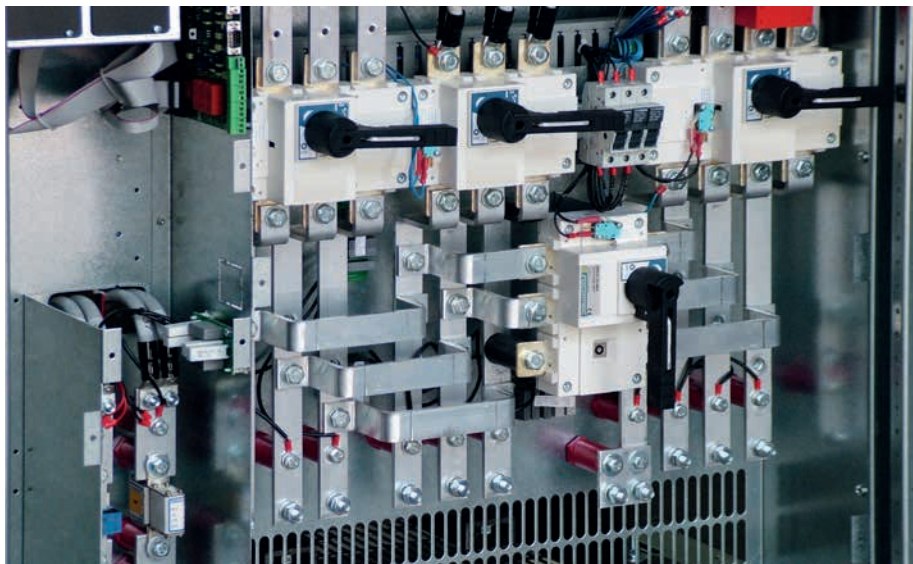

Detail of connection area.

## MAXIMUM RELIABILITY AND AVAILABILITY

- Installation of up to 8 units in redundant or power parallel configuration;
- Hot System Expansion (HSE): allows the addition of a further UPS into an existing system without the need to switch off the existing UPS or switch to bypass. This guarantees maximum load protection, even during maintenance and system expansion;
- Maximum levels of availability, even in the event of an interruption to the parallel bus cable: the system is "FAULT TOLERANT". It is not affected by connection cable faults and continues powering the load without disruption, signalling an alarm condition;
- EFFICIENCY CONTROL Mode (ECM): It optimises the operating efficiency of parallel systems, according to the power required by the load. N+1 redundancy is guaranteed, with every UPS working in parallel at the best load level possible to achieve higher overall efficiency.

## OPTIONS

### • UPS Group Synchroniser (UGS)

Allows two non-parallel UPS systems to remain synchronised even during mains power failure. The UGS also allows the synchronization with any independent power source, generator set and third party UPS.

### • Parallel Systems Joiner (PSJ)

Allows two groups of UPS to be connected in parallel whilst operating, in the event of maintenance (with no interruption to the output), using a power coupling switch. Should one of the UPS in one of the parallel groups fail, it is automatically excluded. The PSJ connects the remaining UPS, to the other parallel group via an external bypass, in order to continue to guarantee load redundancy.

## DIMENSIONS

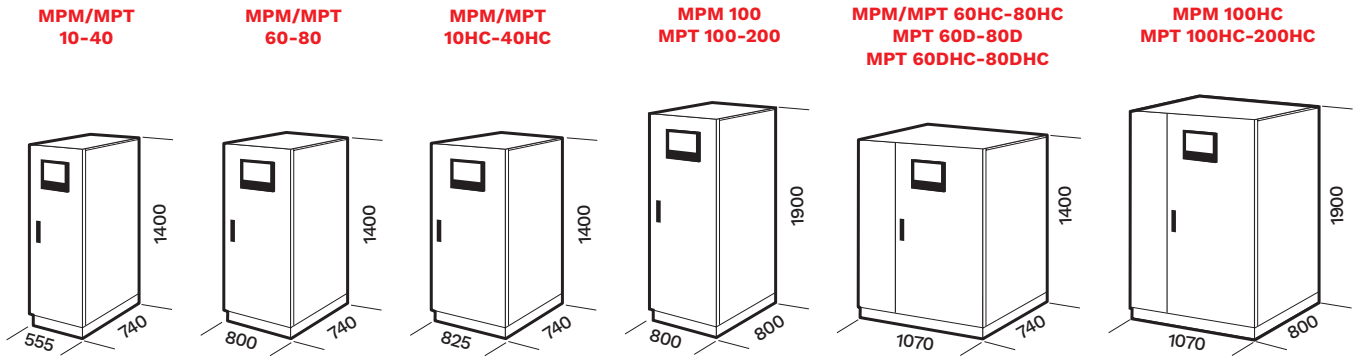

D= Twelve-pulse rectifier version  
 HC= Version with 5<sup>th</sup> or 11<sup>th</sup> harmonic filter.

## DUAL BUS CONFIGURATION

Solution to ensure redundancy through synchronization of two power buses and improving STS operation.

+ Downstream fault discrimination

## DYNAMIC BUS CONFIGURATION

Solution to ensure redundancy of the power supply even during maintenance.

+ High availability and redundancy

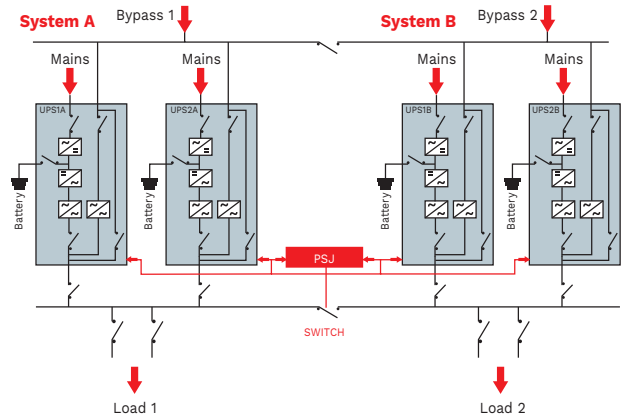
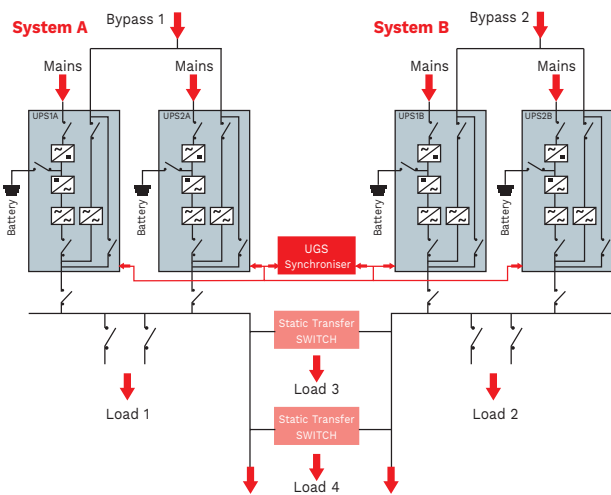

MPT 200 with open doors.

## DETAILS

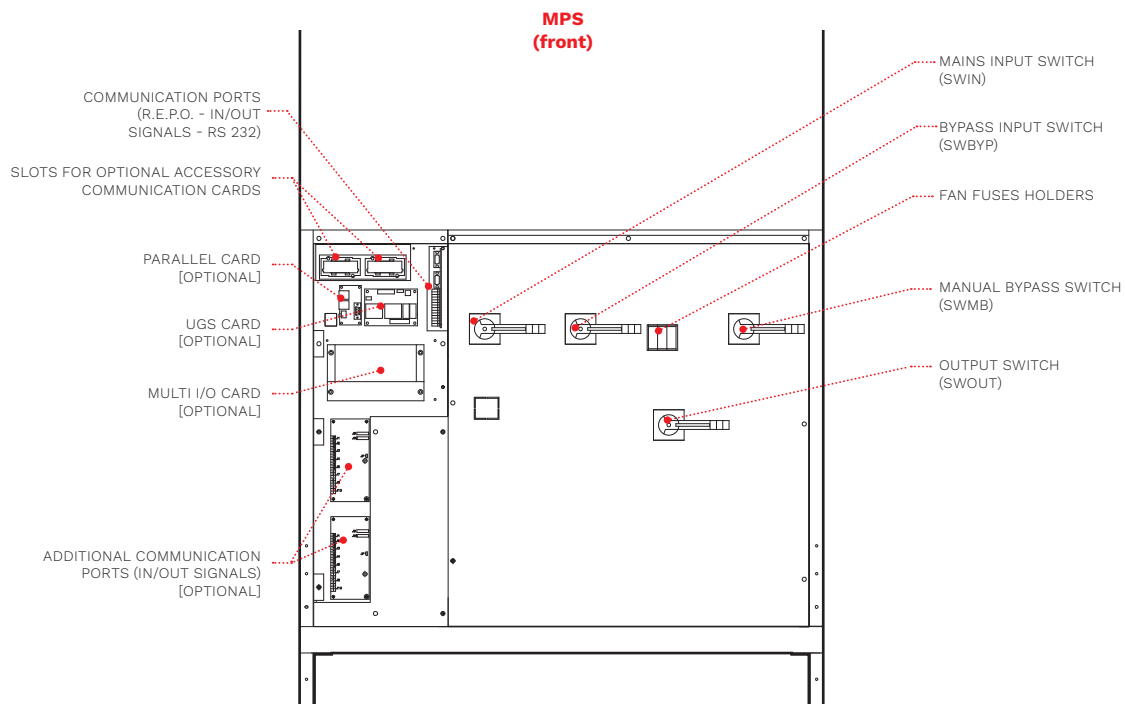

## OPTIONS

| SOFTWARE   |                                      |
|--|--------------------------------------|
| PowerShield <sup>3</sup>                                 |                                      |
| PowerNetGuard  |                                      |
| ACCESSORIES  |                                      |
| NETMAN 208   |                                      |
| MULTICOM 302   |                                      |
| MULTICOM 352   |                                      |
| MULTICOM 411   |                                      |
| MULTICOM 421   |                                      |
| PRODUCT ACCESSORIES                                      |                                      |
| MULTI I/O  | Synchronisation device (UGS)         |
| MULTIPANEL   | Hot connection device (PSJ)          |
| MBB 100 A 2P   | Cold Start                           |
| MBB 125 A 4P   | Parallel Kit                         |
| MBB 400 A 4P   | Battery temperature sensor           |
|  | Top Cable Entry cabinet              |
|  | IP rating IP21, IP31/IP42 on request |
|  | ENERGYMANAGER                        |
|  | Power Absorber (PWA)                 |
| Battery temperature sensor                               |                                      |
| 5 <sup>th</sup> or 11 <sup>th</sup> harmonic filter (HC) |                                      |
| Bypass isolation transformer                             |                                      |

## BATTERY CABINET

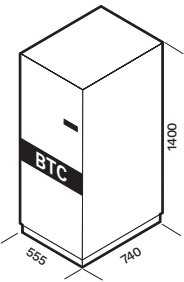
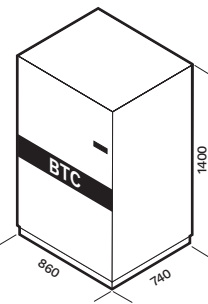
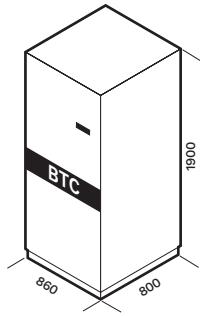
| MODELS          | BTC 1400 384V BB B1 2F<br>BTC 1400 384V AB B1 2F                                  | BTC 1400 384V BB B2 5F<br>BTC 1400 384V BB B3 5F<br>BTC 1400 384V BB B4 5F<br>BTC 1400 384V AB B4 5F | BTC 1900 396V BB L6 3T<br>BTC 1900 396V BB L7 3T<br>BTC 1900 396V BB L8 3T<br>BTC 1900 396V BB L9 3T<br>BTC 1900 396V AB L9 3T |
|-----------------|---|--|--|
| UPS MODELS      | MPT 10-60 / MPM 10-60   | MPT 10-80 / MPM 10-80  | MPT 100-200 / MPM 100  |
| Dimensions [mm] |  |                    |   |

## CABINETS WITH TOP ACCESS FOR CABLES

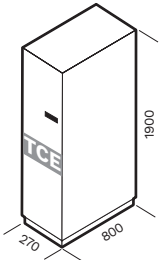
| MODELS          | MPT TCE 100-200   |
|-----------------|---|
| UPS MODELS      | MPT 100-200 / MPM 100   |
| Dimensions [mm] |  |

## SINGLE-PHASE ISOLATION TRANSFORMERS

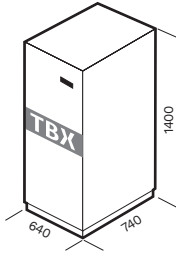
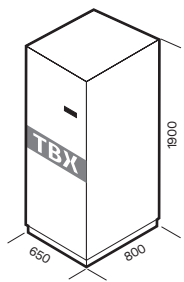
| MODELS          | TBX ISO 10 M<br>TBX ISO 80 M   | TBX ISO 100 M   |
|-----------------|--|---|
| UPS MODELS      | MPM 10-80  | MPM 100   |
| Dimensions [mm] |  |  |

## THREE-PHASE ISOLATION TRANSFORMERS

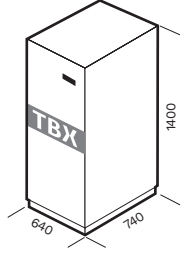
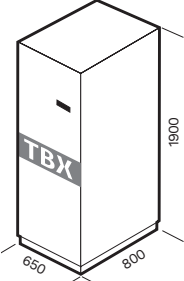
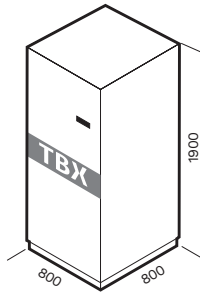
| MODELS          | TBX ISO 10 T Dyn11<br>TBX ISO 80 T Dyn11  | TBX ISO 100 T Dzn0<br>TBX ISO 160 T Dzn0   | TBX ISO 200 T Dzn0  |
|-----------------|---|--|---|
| UPS MODELS      | MPT 10-80 / MPM 10-80   | MPT 100-160 / MPM 100  | MPT 200   |
| Dimensions [mm] |  |  |  |



| MODELS  | MPM 10 <sup>BAT</sup>   | MPM 15 <sup>BAT</sup> | MPM 20 <sup>BAT</sup> | MPM 30 | MPM 40 | MPM 60       | MPM 80 | MPM 100      |  |
|---|---|-----------------------|-----------------------|--------|--------|--------------|--------|--------------|--|
| <b>INPUT</b>  |   |                       |                       |        |        |              |        |              |  |
| Rated voltage [V]                                   | 380 / 400 / 415 three-phase   |                       |                       |        |        |              |        |              |  |
| Voltage tolerance [V]                               | 400 +20% -25% @ full load <sup>1</sup>  |                       |                       |        |        |              |        |              |  |
| Frequency [Hz]                                      | 45 - 65   |                       |                       |        |        |              |        |              |  |
| Soft start  | 0 - 100% in 120 s (selectable)  |                       |                       |        |        |              |        |              |  |
| <b>BYPASS</b>                                       |   |                       |                       |        |        |              |        |              |  |
| Rated voltage [V]                                   | 220 / 230 / 240 single-phase + N  |                       |                       |        |        |              |        |              |  |
| Rated frequency [Hz]                                | 50 or 60 (selectable)   |                       |                       |        |        |              |        |              |  |
| Permitted frequency tolerance                       | ±2% (selectable from ±1% to ±5%)  |                       |                       |        |        |              |        |              |  |
| Standard equipment provided                         | Backfeed protection; separable bypass line  |                       |                       |        |        |              |        |              |  |
| <b>OUTPUT</b>                                       |   |                       |                       |        |        |              |        |              |  |
| Nominal power [kVA]                                 | 10  | 15                    | 20                    | 30     | 40     | 60           | 80     | 100          |  |
| Active power [kW]                                   | 9   | 13.5                  | 18                    | 27     | 36     | 54           | 72     | 90           |  |
| Number of phases                                    | 1 + N   |                       |                       |        |        |              |        |              |  |
| Rated voltage [V]                                   | 220 <sup>1</sup> / 230 / 240 single-phase + N (selectable)  |                       |                       |        |        |              |        |              |  |
| Static stability                                    | ±1%   |                       |                       |        |        |              |        |              |  |
| Dynamic stability                                   | EN 62040-3 class performance 1 non-linear load  |                       |                       |        |        |              |        |              |  |
| Voltage distortion                                  | <1% with linear load / <3% with non-linear load   |                       |                       |        |        |              |        |              |  |
| Crest factor [I <sub>peak</sub> /I <sub>rms</sub> ] | 3:1   |                       |                       |        |        |              |        |              |  |
| Frequency stability on battery                      | 0.05%   |                       |                       |        |        |              |        |              |  |
| Frequency [Hz]                                      | 50 or 60 (selectable)   |                       |                       |        |        |              |        |              |  |
| Overload  | 110% for 60 min; 125% for 10 min; 150% for 1 min  |                       |                       |        |        |              |        |              |  |
| <b>BATTERIES</b>                                    |   |                       |                       |        |        |              |        |              |  |
| Type  | VRLA AGM/GEL/NiCd/Li-ion/SuperCaps  |                       |                       |        |        |              |        |              |  |
| Recharging method                                   | One level, Two level, Cyclic recharge (selectable)  |                       |                       |        |        |              |        |              |  |
| Battery arrangement (parallel systems)              | Separate/Common   |                       |                       |        |        |              |        |              |  |
| <b>OVERALL SPECIFICATIONS</b>                       |   |                       |                       |        |        |              |        |              |  |
| Weight without batteries [kg]                       | 200   | 220                   | 230                   | 255    | 302    | 416          | 616    | 665          |  |
| Dimensions (WxDxH) [mm]                             | 555x740x1400  |                       |                       |        |        | 800x740x1400 |        | 800x800x1900 |  |
| Remote signals                                      | 1x opto insulated Input and 3x relays Outputs   |                       |                       |        |        |              |        |              |  |
| Auxiliary signals                                   | R.E.P.O. - External manual bypass - External output switch  |                       |                       |        |        |              |        |              |  |
| Communications                                      | UPS status LEDs - Graphic display - 2 slots for communications interface - 2x RS232   |                       |                       |        |        |              |        |              |  |
| Ambient temperature for the UPS                     | 0 °C - +40 °C   |                       |                       |        |        |              |        |              |  |
| Recommended temperature for battery life            | +20 °C - +25 °C   |                       |                       |        |        |              |        |              |  |
| Range of relative humidity                          | 5-95% non-condensing  |                       |                       |        |        |              |        |              |  |
| Colour  | RAL 7016  |                       |                       |        |        |              |        |              |  |
| Noise level at 1 m [dBA ±2]<br>ECO Mode             | 60  |                       |                       | 62     |        |              | 65     |              |  |
| IP rating   | IP20  |                       |                       |        |        |              |        |              |  |
| ECO Mode efficiency                                 | up to 98%   |                       |                       |        |        |              |        |              |  |
| Standards   | European directives: LV 2014/35/EU low voltage Directive EMC 2014/30/EU electromagnetic compatibility Directive Standards: Safety IEC EN 62040-1; EMC IEC EN 62040-2; RoHS compliant Classification in accordance with IEC 62040-3 (Voltage frequency Independent) VFI - SS - 111 |                       |                       |        |        |              |        |              |  |
| Moving the UPS                                      | Pallet jack   |                       |                       |        |        |              |        |              |  |

<sup>1</sup> For wider tolerance conditions apply.

<sup>BAT</sup> Also available with internal batteries.

| MODELS  | MPT 10 <sup>BAT</sup>   | MPT 15 <sup>BAT</sup> | MPT 20 <sup>BAT</sup> | MPT 30 | MPT 40 | MPT 60       | MPT 80 |
|---|---|-----------------------|-----------------------|--------|--------|--------------|--------|
| <b>INPUT</b>  |   |                       |                       |        |        |              |        |
| Rated voltage [V]                                   | 380 / 400 / 415 three-phase   |                       |                       |        |        |              |        |
| Voltage tolerance [V]                               | 400 +20% -25% @ full load <sup>1</sup>  |                       |                       |        |        |              |        |
| Frequency [Hz]                                      | 45 - 65   |                       |                       |        |        |              |        |
| Soft start  | 0 - 100% in 120 s (selectable)  |                       |                       |        |        |              |        |
| <b>BYPASS</b>                                       |   |                       |                       |        |        |              |        |
| Rated voltage [V]                                   | 380 / 400 / 415 three-phase + N   |                       |                       |        |        |              |        |
| Rated frequency [Hz]                                | 50 or 60 (selectable)   |                       |                       |        |        |              |        |
| Permitted frequency tolerance                       | ±2% (selectable from ±1% to ±5%)  |                       |                       |        |        |              |        |
| Standard equipment provided                         | Backfeed protection; separable bypass line  |                       |                       |        |        |              |        |
| <b>OUTPUT</b>                                       |   |                       |                       |        |        |              |        |
| Nominal power [kVA]                                 | 10  | 15                    | 20                    | 30     | 40     | 60           | 80     |
| Active power [kW]                                   | 9   | 13.5                  | 18                    | 27     | 36     | 54           | 72     |
| Number of phases                                    | 3 + N   |                       |                       |        |        |              |        |
| Rated voltage [V]                                   | 380 <sup>1</sup> / 400 / 415 three-phase + N (selectable)   |                       |                       |        |        |              |        |
| Static stability                                    | ±1%   |                       |                       |        |        |              |        |
| Dynamic stability                                   | EN 62040-3 class performance 1 non-linear load  |                       |                       |        |        |              |        |
| Voltage distortion                                  | <1% with linear load / <3% with non-linear load   |                       |                       |        |        |              |        |
| Crest factor [I <sub>peak</sub> /I <sub>rms</sub> ] | 3:1   |                       |                       |        |        |              |        |
| Frequency stability on battery                      | 0.05%   |                       |                       |        |        |              |        |
| Frequency [Hz]                                      | 50 or 60 (selectable)   |                       |                       |        |        |              |        |
| Overload  | 110% for 60 min; 125% for 10 min; 150% for 1 min  |                       |                       |        |        |              |        |
| <b>BATTERIES</b>                                    |   |                       |                       |        |        |              |        |
| Type  | VRLA AGM/GEL/NiCd/Li-ion/SuperCaps  |                       |                       |        |        |              |        |
| Recharging method                                   | One level, Two level, Cyclic recharge (selectable)  |                       |                       |        |        |              |        |
| Battery arrangement (parallel systems)              | Separate/Common   |                       |                       |        |        |              |        |
| <b>OVERALL SPECIFICATIONS</b>                       |   |                       |                       |        |        |              |        |
| Weight without batteries [kg]                       | 228   | 241                   | 256                   | 315    | 335    | 460          | 520    |
| Dimensions (WxDxH) [mm]                             | 555x740x1400  |                       |                       |        |        | 800x740x1400 |        |
| Remote signals                                      | 1x opto insulated Input and 3x relays Outputs   |                       |                       |        |        |              |        |
| Auxiliary signals                                   | R.E.P.O. - External manual bypass - External output switch  |                       |                       |        |        |              |        |
| Communications                                      | UPS status LEDs - Graphic display - 2 slots for communications interface - 2x RS232   |                       |                       |        |        |              |        |
| Ambient temperature for the UPS                     | 0 °C - +40 °C   |                       |                       |        |        |              |        |
| Recommended temperature for battery life            | +20 °C - +25 °C   |                       |                       |        |        |              |        |
| Range of relative humidity                          | 5-95% non-condensing  |                       |                       |        |        |              |        |
| Colour  | RAL 7016  |                       |                       |        |        |              |        |
| Noise level at 1 m [dBA ±2]<br>ECO Mode             | 60  |                       |                       | 62     |        |              |        |
| IP rating   | IP20  |                       |                       |        |        |              |        |
| ECO Mode efficiency                                 | up to 98%   |                       |                       |        |        |              |        |
| Standards   | European directives: LV 2014/35/EU low voltage Directive EMC 2014/30/EU electromagnetic compatibility Directive Standards: Safety IEC EN 62040-1; EMC IEC EN 62040-2; RoHS compliant Classification in accordance with IEC 62040-3 (Voltage frequency Independent) VFI - SS - 111 |                       |                       |        |        |              |        |
| Moving the UPS                                      | Pallet jack   |                       |                       |        |        |              |        |

<sup>1</sup> For wider tolerance conditions apply.

<sup>BAT</sup> Also available with internal batteries.



| MODELS  | MPT 100   | MPT 120 | MPT 160 | MPT 200 |
|---|---|---------|---------|---------|
| <b>INPUT</b>  |   |         |         |         |
| Rated voltage [V]                                   | 380 / 400 / 415 three-phase   |         |         |         |
| Voltage tolerance [V]                               | 400 +20% -25% @ full load <sup>1</sup>  |         |         |         |
| Frequency [Hz]                                      | 45 - 65   |         |         |         |
| Soft start  | 0 - 100% in 120 s (selectable)  |         |         |         |
| <b>BYPASS</b>                                       |   |         |         |         |
| Rated voltage [V]                                   | 380 / 400 / 415 three-phase + N   |         |         |         |
| Rated frequency [Hz]                                | 50 or 60 (selectable)   |         |         |         |
| Permitted frequency tolerance                       | ±2% (selectable from ±1% to ±5%)  |         |         |         |
| Standard equipment provided                         | Backfeed protection; separable bypass line  |         |         |         |
| <b>OUTPUT</b>                                       |   |         |         |         |
| Nominal power [kVA]                                 | 100   | 120     | 160     | 200     |
| Active power [kW]                                   | 90  | 108     | 144     | 180     |
| Number of phases                                    | 3 + N   |         |         |         |
| Rated voltage [V]                                   | 380 <sup>1</sup> / 400 / 415 three-phase + N (selectable)   |         |         |         |
| Static stability                                    | ±1%   |         |         |         |
| Dynamic stability                                   | EN 62040-3 class performance 1 non-linear load  |         |         |         |
| Voltage distortion                                  | <1% with linear load / <3% with non-linear load   |         |         |         |
| Crest factor [I <sub>peak</sub> /I <sub>rms</sub> ] | 3:1   |         |         |         |
| Frequency stability on battery                      | 0.05%   |         |         |         |
| Frequency [Hz]                                      | 50 or 60 (selectable)   |         |         |         |
| Overload  | 110% for 60 min; 125% for 10 min; 150% for 1 min  |         |         |         |
| <b>BATTERIES</b>                                    |   |         |         |         |
| Type  | VRLA AGM/GEL/NiCd/Li-ion/SuperCaps  |         |         |         |
| Recharging method                                   | One level, Two level, Cyclic recharge (selectable)  |         |         |         |
| Battery arrangement (parallel systems)              | Separate/Common   |         |         |         |
| <b>OVERALL SPECIFICATIONS</b>                       |   |         |         |         |
| Weight [kg]   | 620   | 640     | 700     | 800     |
| Dimensions (WxDxH) [mm]                             | 800x800x1900  |         |         |         |
| Remote signals                                      | 1x opto insulated Input and 3x relays Outputs   |         |         |         |
| Auxiliary signals                                   | R.E.P.O. - External manual bypass - External output switch  |         |         |         |
| Communications                                      | UPS status LEDs - Graphic display - 2 slots for communications interface - 2x RS232   |         |         |         |
| Ambient temperature for the UPS                     | 0 °C - +40 °C   |         |         |         |
| Recommended temperature for battery life            | +20 °C - +25 °C   |         |         |         |
| Range of relative humidity                          | 5-95% non-condensing  |         |         |         |
| Colour  | RAL 7016  |         |         |         |
| Noise level at 1 m [dBA ±2] ECO Mode                | 65  |         | 68      |         |
| IP rating   | IP20  |         |         |         |
| ECO Mode efficiency                                 | up to 98%   |         |         |         |
| Standards   | European directives: LV 2014/35/EU low voltage Directive EMC 2014/30/EU electromagnetic compatibility Directive Standards: Safety IEC EN 62040-1; EMC IEC EN 62040-2; RoHS compliant Classification in accordance with IEC 62040-3 (Voltage frequency Independent) VFI - SS - 111 |         |         |         |
| Moving the UPS                                      | Pallet jack   |         |         |         |

<sup>1</sup> For wider tolerance conditions apply.

# Master HP & Master HE



DATACENTER



E-MEDICAL



EMERGENCY



INDUSTRY



TRANSPORT

**3:3** Master HP 100-600 kVA  
Master HE 100-800 kVA



ONLINE



Tower



Lithium  
compatible



Service  
1st start



SmartGrid  
ready



Supercaps  
UPS

## HIGHLIGHTS

- **Best in class efficiency**
- **Output power factor 1 (HE models)**
- **IGBT rectifier**
- **Galvanic isolation**
- **High overload capacity**
- **Hot System Expansion (HSE)**

The Master HP and Master HE series represent the optimum Riello UPS solution for installations requiring high efficiency, a low impact on the mains and maximum power availability. Their ON LINE technology (classified as VFI-SS-111) combined with the transformer-based design and IGBT rectifier provide not only maximum protection and power quality to the most critical applications such as data centers or industrial loads, but also minimises the impact on the mains supply and reduces the risk of oversizing generator sets.

### MASTER HE - HIGH EFFICIENCY

Available from 100 to 800 kVA, the Master HE series shares the same consolidated and reliable double conversion technology

as the Master HP. The use of IGBTs for both the rectifier and inverter stages reduces any switching losses, ensuring nominal power with no downgrading up to 40 °C.

The DSP (Digital Signal Processor) control allows the use of more complex and high performance algorithms that guarantee better static and dynamic performance. Moreover, the firmware and main components of the Master HE are specifically designed to ensure the best in class efficiency of 95.5% in ON LINE Mode and unity output power factor (kW=kVA), which means 11% higher active power than a comparable UPS with 0.9 output power factor.



## MAXIMISED COST SAVINGS

Master HP/HE supports the SMART ACTIVE Mode, meaning they are capable of selecting the best operating mode between ON LINE or ECO depending on the quality of the mains, maximising UPS efficiency.

Master HP/HE also guarantees high efficiency at partial loads and in case of parallel installations, the units can work in EFFICIENCY CONTROL Mode (ECM) to increase efficiency whilst still ensuring the required redundancy: depending on the real-time load, it sets surplus UPS units to "idle", allowing the live units to run at the most efficient working point. ECM implements also a smart logic to ensure the units and components age at a similar rate.

## POWER CONTINUITY

For years, Riello UPS has developed and supplied solutions for dealing with the different requirements and problems that inevitably arise in critical applications. Riello UPS offers flexible, high-availability solutions that are able to adapt to different system structures and critical levels. Riello UPS creates UPS systems that can tolerate a number of components or subsystem failures, while continuing to operate normally, providing power without interruption.

This is achieved by careful design, installing redundant elements, eliminating common failure points, scheduling maintenance activities and controlling and supervising the system operating parameters and environment. The TEC service team is ready to provide guidance and advice on projects.

## ZERO IMPACT SOURCE

The Master HP/HE series features the added advantages of the Zero Impact Source formula offered by an IGBT-based rectifier assembly. This eliminates problems connected with installation in networks with limited power capacity, where the UPS is supplied by a generator set, or anywhere there are compatibility problems with loads generate current harmonics. Master HP/HE series UPS have zero impact on the power supply source, whether it is a mains grid or generator set:

- input current distortion <3%;
- input power factor 0.99;
- power walk-in function that ensures progressive rectifier start up;
- start up delay function, to restart the rectifiers when mains power is restored if there are several UPS in the system.

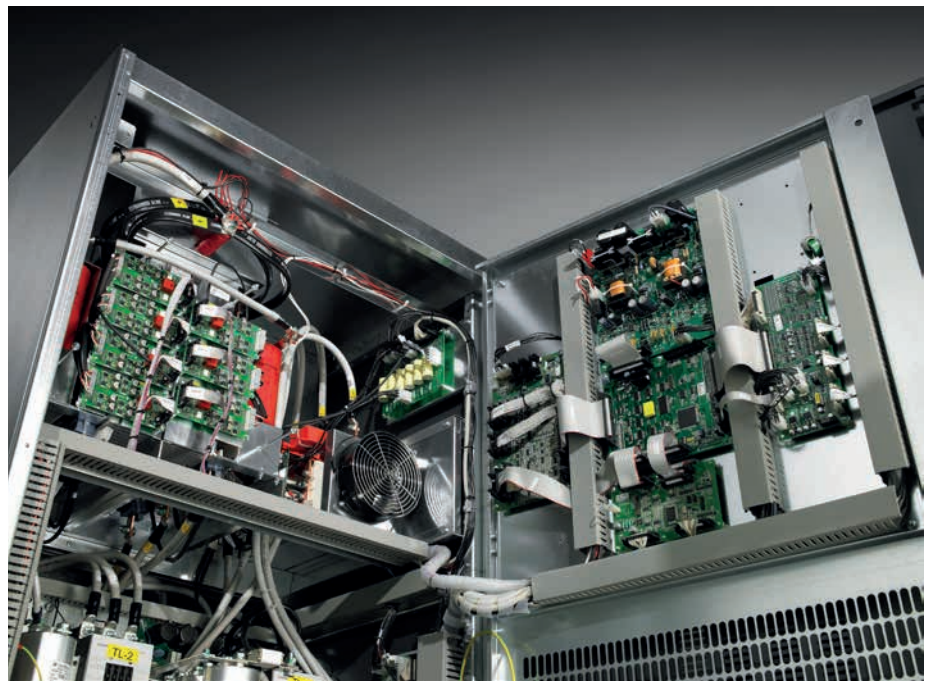

## BATTERY CARE SYSTEM

The Master HP/HE series of UPS include a range of features designed to prolong battery life and reduce their usage such as different recharging methods, deep discharge protection, current limitation and voltage compensation according to the battery room temperature. Thanks to the STEP-UP/STEP-DOWN converter that recharges and discharges the battery, ripple current is extremely reduced; this arrangement enhances the battery reliability since it is no longer connected to UPS DC bus.

## COMPLETE GALVANIC SEPARATION

Master HP/HE UPS features an output isolation transformer (delta zig/zag type) on the inverter as part of the inverter circuit inside the UPS cabinet, providing galvanic isolation between the load and the battery with improved versatility in system configuration, allowing:

- Complete UPS output galvanic isolation for critical infrastructures from the battery DC power source;
- Two truly separated supply inputs (main and bypass), which can be taken from two different power sources (with different neutrals); this is particularly well suited to parallel systems in order to ensure selectivity between the two sources, thus improving the reliability of the entire installation;
- No neutral input connection is required at the UPS rectifier input stage; this method is particularly favourable in order to prevent the transmission of common

neutral disturbances via the neutral conductor;

- No effects to the UPS output performance or reduced impact of the inverter power components whilst supplying specific loads; in addition the inverter transformer minimises the impact of third harmonic disturbances.
- High inverter short circuit current to clear faults which occur between phase and neutral on load side (up to three times nominal current).
- Output transformer housed within the cabinet which allows for a significant reduction in the footprint and provides space saving.

## MAIN FEATURES

- High efficiency up to 99.4% (STANDBY ON Mode);
- Compact size: e.g. only 0.85 m<sup>2</sup> for the Master HP/HE 250 kVA;
- Reduced weight for transformer-based UPS;
- Double load protection, both electronic and galvanic, towards the battery.

The entire Master HP/HE range is suitable for use in a wide range of applications. Thanks to the flexibility of configuration, available options and accessories, it is suitable for supplying any type of load, e.g. capacitive loads such as blade servers, rather than motor drivers or any other critical vertical application.

## SMART GRID READY

Being Smart Grid Ready, Master HP/HE allows for the implementation of energy

storage solutions and at the same time ensures extremely high levels of efficiency. It is also able to independently select the most efficient operating method based on the status of the grid. Master HP/HE UP can electronically interface with the ENERGYMANAGER using the smart grid communication network.

#### **MAXIMUM RELIABILITY AND AVAILABILITY**

- Distributed parallel configuration of up to 8 units per redundant (N+1) or power parallel system;
- Centralised parallel system up to 7 units with centralised bypass system (MSB);
- Dual bus configuration: allows two or more non-parallel UPS devices to remain synchronised even during mains power failure by adding the UGS device. The UGS also enables a Riello UPS to be synchronised with another power source that is independent and of a different power rating;
- Dynamic Dual bus configuration: allows two groups of UPS with the PSJ device to be connected in parallel whilst operating, in the event of maintenance (with no interruption to the output), using a power coupling switch. Should one of the UPS in one of the parallel groups fail, it is automatically excluded. The PSJ connects the remaining UPS, to the other parallel group via an external bypass, in order to continue to guarantee load redundancy. Allows two groups of UPS to be connected in parallel whilst operating, in the event of maintenance (with no interruption to the output), using a power coupling switch. Should one of the UPS in one of the parallel groups fail, it is automatically excluded. The PSJ connects the remaining UPS, to the other parallel group via an external bypass, in order to continue to guarantee load redundancy;
- Hot System Expansion (HSE): allows the addition of a further UPS into an existing system, without the need to switch off the existing UPS or switch to bypass. This guarantees maximum load protection, even during maintenance and system expansion;
- Maximum levels of availability, even in the event of an interruption to the parallel bus cable: the system is "FAULT TOLERANT". It is not affected by connection cable faults and continues powering the load without disruption, signalling an alarm condition;
- EFFICIENCY CONTROL Mode (ECM): it optimises the operating efficiency of parallel systems, according to the power

required by the load. N+1 redundancy is guaranteed, with every UPS working in parallel at the best load level possible to achieve higher overall efficiency.

#### **CENTRALISED BYPASS CABINET**

The Riello UPS centralised bypass (named MSB) is available in five power ratings: 800, 1200, 1600, 2000 and 3000 kVA.

Intermediate solutions within this range can be made, as well as solutions greater than 3000 kVA based on the requirements of the customer or application. The MSB centralised bypass can be integrated with the Master HP/HE range; in fact it can be associated with up to 7 UPS modules in the range, obviously without static bypass and associated bypass line (named MHT/MHE NBP). Based on requirements thus ensuring complete flexibility aimed at satisfying all power and power supply requirements.

Riello UPS provides the same flexibility as

the Master HP for the battery bus, so that the UPS units can operate with both shared and separate batteries.

The 800 kVA MSB is supplied with a comprehensive cabinet including bypass line input switch (SWBY), system output switch (SWOUT) and manual bypass (SWMB). The 1200 and 1600 kVA models are supplied as standard without any switches but can be equipped with the same, suitably proportioned, switches provided for the 800 kVA model (SWBY, SWOUT, SWMB).

The more powerful models are supplied with no switches; the bulky sizes of disconnection devices at these power levels are such as to favour tailor-made engineering solutions as an additional part of the system attestation and distribution cabinets where the centralised bypass and MHT/MHE NBP modules are fitted.



Master Static Bypass MSB

## PARALLEL CONFIGURATION OF UP TO 8 UPS UNITS WITH DISTRIBUTED BYPASS

Parallel architecture to ensure redundancy of the power source.

**+ Flexibility and modularity and no single point of failure.**

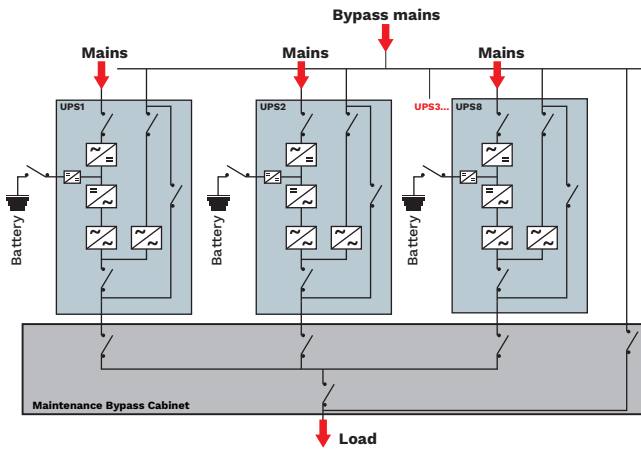

## PARALLEL CONFIGURATION OF UP TO 7 UNITS WITH CENTRALISED BYPASS

Parallel architecture to ensure redundancy of the power source, with independent bypass management.

**+ Selectivity of downstream faults in bypass operation**

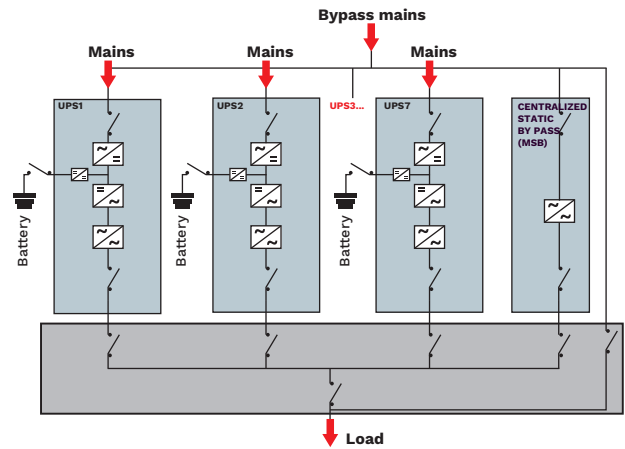

## DUAL BUS CONFIGURATION

Solution to ensure redundancy through synchronization of two power buses and improving STS operation.

**+ Downstream fault discrimination**

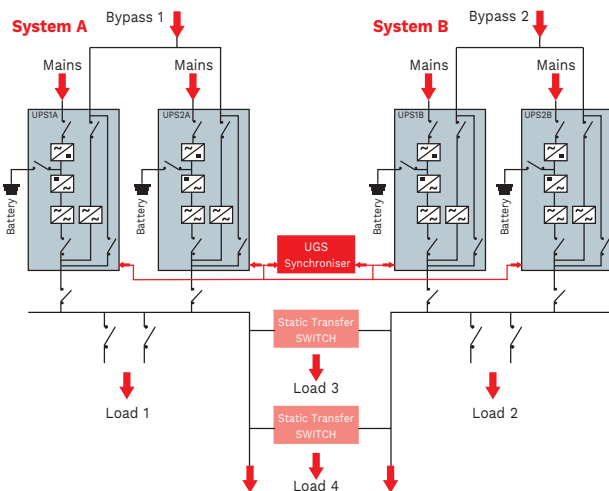

## DYNAMIC DUAL BUS CONFIGURATION

Solution to ensure redundancy of the power supply even during maintenance.

**+ High availability and redundancy**

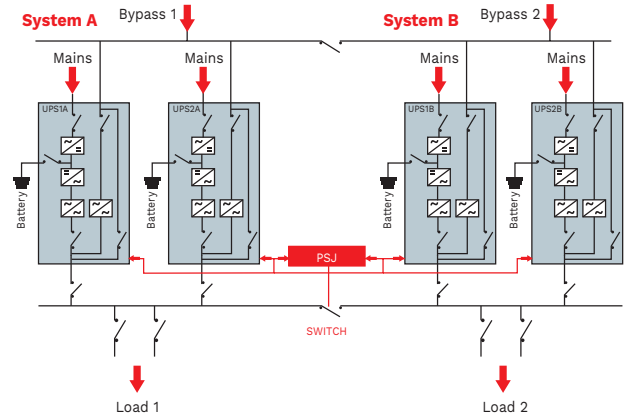

## OPTIONS

### SOFTWARE

PowerShield<sup>3</sup>  
PowerNetGuard

### ACCESSORIES

NETMAN 208  
MULTICOM 302  
MULTICOM 352  
MULTICOM 411  
MULTICOM 421  
MULTI I/O  
MULTIPANEL  
MBB 400 A 4P

### PRODUCT ACCESSORIES

Bypass isolation transformer  
Parallel kit  
Synchronisation device (UGS)  
Hot connection device (PSJ)  
Top Cable Entry cabinet  
IP rating IP21, IP31/IP42 on request  
Battery temperature sensor  
Cold start  
ENERGYMANAGER  
DC filter  
Power Absorber (PWA)

## DIMENSIONS

**MHT / MHE 100**  
**MHT / MHE 120**

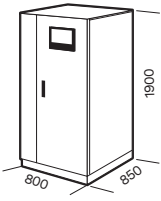

**MHT / MHE 160**  
**MHT / MHE 200**  
**MHT / MHE 250**

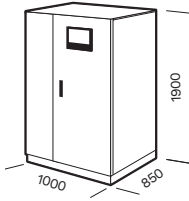

**MHT / MHE 300**  
**MHT / MHE 400**

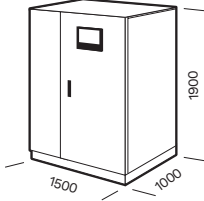

**MHT / MHE 500**  
**MHT / MHE 600**

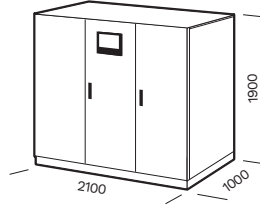

**MHE 800**

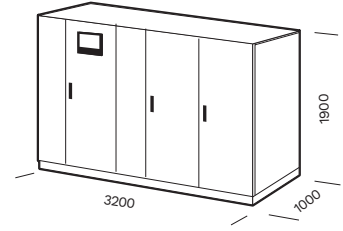

**MSB 800**

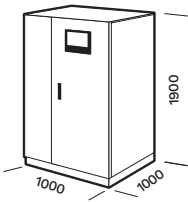

**MSB 1200**

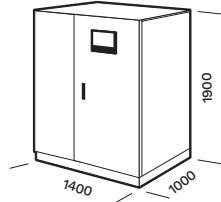

**MSB 1600 / MSB 2000**

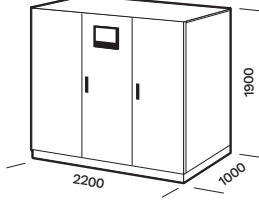

**MSB 3000**

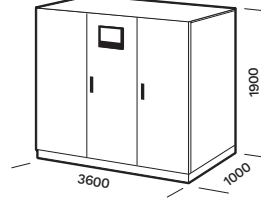

## BATTERY CABINET

| MODELS     | <b>BTC 1900 480V BB V6 3T</b><br><b>BTC 1900 480V BB V7 3T</b><br><b>BTC 1900 480V BB V8 3T</b><br><b>BTC 1900 480V BB V9 3T</b><br><b>BTC 1900 480V AB V9 3T</b> |
|------------|---|
| UPS MODELS | MHT 100-600 / MHE 100-800   |

Dimensions [mm]

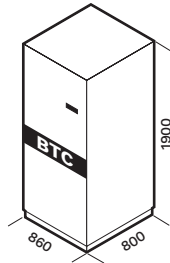

## CABINETS WITH TOP ACCESS FOR CABLES

| MODELS     | MHT TCE 100÷250            | MHT TCE 300÷800             |
|------------|----------------------------|-----------------------------|
| UPS MODELS | MHT 100-250<br>MHE 100-250 | MHT 300-600<br>MHE 300-800* |

Dimensions [mm]

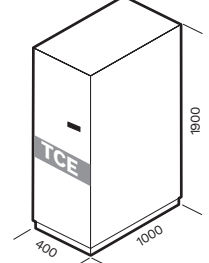
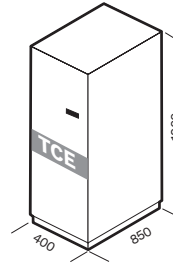

\*2 pieces needed for MHE 800

## THREE-PHASE ISOLATION TRANSFORMERS

| MODELS     | <b>TBX ISO 100 T Dzn0</b><br><b>TBX ISO 160 T Dzn0</b> | <b>TBX ISO 200 T Dzn0</b><br><b>TBX ISO 250 T Dzn0</b> | <b>TBX ISO 300 T Dzn0</b><br><b>TBX ISO 600 T Dzn0</b> |
|------------|--|--|--|
| UPS MODELS | MHT 100-160 / MHE 100-160                              | MHT 200-250 / MHE 200-250                              | MHT 300-600 / MHE 300-600                              |

Dimensions [mm]

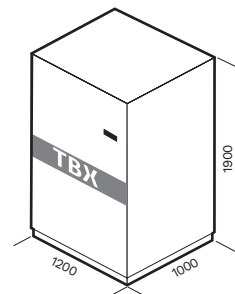
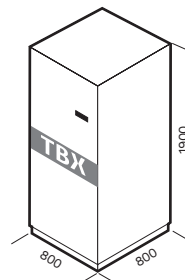
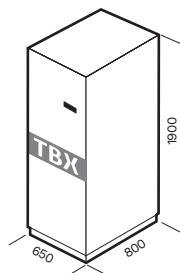

Note: TBX ISO 800 T Dzn0 for MHE 800 available on request.



| MODELS  | MHT 100   | MHT 120 | MHT 160       | MHT 200 | MHT 250 | MHT 300        | MHT 400 | MHT 500        | MHT 600 |  |
|---|---|---------|---------------|---------|---------|----------------|---------|----------------|---------|--|
| <b>INPUT</b>  |   |         |               |         |         |                |         |                |         |  |
| Rated voltage [V]                                   | 380 / 400 / 415 three-phase   |         |               |         |         |                |         |                |         |  |
| Voltage tolerance [V]                               | 400 ±20% @ full load <sup>1</sup>   |         |               |         |         |                |         |                |         |  |
| Frequency [Hz]                                      | 45 - 65   |         |               |         |         |                |         |                |         |  |
| Power factor  | >0.99   |         |               |         |         |                |         |                |         |  |
| Harmonic current distortion [THDi]                  | <3%   |         |               |         |         |                |         |                |         |  |
| Soft start  | 0 - 100% in 120 s (selectable)  |         |               |         |         |                |         |                |         |  |
| <b>BYPASS</b>                                       |   |         |               |         |         |                |         |                |         |  |
| Rated voltage [V]                                   | 380 / 400 / 415 three-phase + N   |         |               |         |         |                |         |                |         |  |
| Rated Frequency [Hz]                                | 50 or 60 (selectable)   |         |               |         |         |                |         |                |         |  |
| Frequency tolerance                                 | ±2% (selectable from ±1% to ±5%)  |         |               |         |         |                |         |                |         |  |
| Standard equipment provided                         | Backfeed protection; separable bypass line  |         |               |         |         |                |         |                |         |  |
| <b>OUTPUT</b>                                       |   |         |               |         |         |                |         |                |         |  |
| Nominal power [kVA]                                 | 100   | 120     | 160           | 200     | 250     | 300            | 400     | 500            | 600     |  |
| Active power [kW]                                   | 90  | 108     | 144           | 180     | 225     | 270            | 360     | 450            | 540     |  |
| Number of phases                                    | 3 + N   |         |               |         |         |                |         |                |         |  |
| Rated voltage [V]                                   | 380 <sup>1</sup> / 400 / 415 three-phase + N (selectable)   |         |               |         |         |                |         |                |         |  |
| Static stability                                    | ±1%   |         |               |         |         |                |         |                |         |  |
| Dynamic stability                                   | EN 62040-3 class performance 1 non-linear load  |         |               |         |         |                |         |                |         |  |
| Voltage distortion                                  | <1% with linear load / <3% with non-linear load   |         |               |         |         |                |         |                |         |  |
| Crest factor [I <sub>peak</sub> /I <sub>rms</sub> ] | 3:1   |         |               |         |         |                |         |                |         |  |
| Frequency stability on battery                      | 0.05%   |         |               |         |         |                |         |                |         |  |
| Frequency [Hz]                                      | 50 or 60 (selectable)   |         |               |         |         |                |         |                |         |  |
| Overload  | 110% for 60 min; 125% for 10 min; 150% for 1 min  |         |               |         |         |                |         |                |         |  |
| <b>BATTERIES</b>                                    |   |         |               |         |         |                |         |                |         |  |
| Type  | VRLA AGM/GEL/NiCd/Li-ion/SuperCaps  |         |               |         |         |                |         |                |         |  |
| Recharging method                                   | One level, Two level, Cyclic recharge (selectable)  |         |               |         |         |                |         |                |         |  |
| Battery arrangement (parallel systems)              | Separate/Common   |         |               |         |         |                |         |                |         |  |
| <b>OVERALL SPECIFICATIONS</b>                       |   |         |               |         |         |                |         |                |         |  |
| Weight [kg]   | 700   | 755     | 830           | 956     | 1060    | 1500           | 1720    | 2525           | 2700    |  |
| Dimensions (WxDxH) [mm]                             | 800x850x1900  |         | 1000x850x1900 |         |         | 1500x1000x1900 |         | 2100x1000x1900 |         |  |
| Remote signals                                      | 1x opto insulated Input and 3x relays Outputs   |         |               |         |         |                |         |                |         |  |
| Auxiliary signals                                   | R.E.P.O. - External manual bypass - External output switch  |         |               |         |         |                |         |                |         |  |
| Communications                                      | UPS status LEDs - Graphic display - 2 slots for communications interface - 2x RS232   |         |               |         |         |                |         |                |         |  |
| Ambient temperature for the UPS                     | 0 °C - +40 °C   |         |               |         |         |                |         |                |         |  |
| Recommended temperature for battery life            | +20 °C - +25 °C   |         |               |         |         |                |         |                |         |  |
| Range of relative humidity                          | 5-95% non-condensing  |         |               |         |         |                |         |                |         |  |
| Colour  | RAL 7016  |         |               |         |         |                |         |                |         |  |
| Noise level at 1 m [dBA ±2] ECO Mode                | 65  |         | 68            |         |         | 72             |         |                |         |  |
| IP rating   | IP20  |         |               |         |         |                |         |                |         |  |
| ECO Mode efficiency                                 | up to 98%   |         |               |         |         |                |         |                |         |  |
| Standards   | European directives: LV 2014/35/EU low voltage Directive EMC 2014/30/EU electromagnetic compatibility Directive Standards: Safety IEC EN 62040-1; EMC IEC EN 62040-2; RoHS compliant Classification in accordance with IEC 62040-3 (Voltage frequency Independent) VFI - SS - 111 |         |               |         |         |                |         |                |         |  |
| Moving the UPS                                      | Pallet jack   |         |               |         |         |                |         |                |         |  |

<sup>1</sup> For wider tolerance conditions apply.

| MODELS  | MHE 100   | MHE 120 | MHE 160       | MHE 200 | MHE 250 | MHE 300        | MHE 400 | MHE 500        | MHE 600 | MHE 800        |
|---|---|---------|---------------|---------|---------|----------------|---------|----------------|---------|----------------|
| <b>INPUT</b>  |   |         |               |         |         |                |         |                |         |                |
| Rated voltage [V]                                   | 380 / 400 / 415 three-phase   |         |               |         |         |                |         |                |         |                |
| Voltage tolerance [V]                               | 400 ±20% @ full load <sup>1</sup>   |         |               |         |         |                |         |                |         |                |
| Frequency [Hz]                                      | 45 - 65   |         |               |         |         |                |         |                |         |                |
| Power factor  | >0.99   |         |               |         |         |                |         |                |         |                |
| Harmonic current distortion [THDi]                  | <3%   |         |               |         |         |                |         |                |         |                |
| Soft start  | 0 - 100% in 120 s (selectable)  |         |               |         |         |                |         |                |         |                |
| <b>BYPASS</b>                                       |   |         |               |         |         |                |         |                |         |                |
| Rated voltage [V]                                   | 380 / 400 / 415 three-phase + N   |         |               |         |         |                |         |                |         |                |
| Frequency [Hz]                                      | 50 or 60 selectable   |         |               |         |         |                |         |                |         |                |
| Frequency tolerance                                 | ±2% (selectable from ±1% to ±5%)  |         |               |         |         |                |         |                |         |                |
| Standard equipment                                  | Backfeed protection; separable bypass line  |         |               |         |         |                |         |                |         |                |
| <b>OUTPUT</b>                                       |   |         |               |         |         |                |         |                |         |                |
| Nominal power [kVA]                                 | 100   | 120     | 160           | 200     | 250     | 300            | 400     | 500            | 600     | 800            |
| Active power [kW]                                   | 100   | 120     | 160           | 200     | 250     | 300            | 400     | 500            | 600     | 800            |
| Number of phases                                    | 3 + N   |         |               |         |         |                |         |                |         |                |
| Rated voltage [V]                                   | 380 <sup>1</sup> / 400 / 415 three-phase + N (selectable)   |         |               |         |         |                |         |                |         |                |
| Static stability                                    | ±1%   |         |               |         |         |                |         |                |         |                |
| Dynamic stability                                   | EN 62040-3 class performance 1 non-linear load  |         |               |         |         |                |         |                |         |                |
| Voltage distortion                                  | <1% with linear load / <3% with non-linear load   |         |               |         |         |                |         |                |         |                |
| Crest factor [I <sub>peak</sub> /I <sub>rms</sub> ] | 3:1   |         |               |         |         |                |         |                |         |                |
| Frequency stability on battery                      | 0.05%   |         |               |         |         |                |         |                |         |                |
| Frequency [Hz]                                      | 50 or 60 (selectable)   |         |               |         |         |                |         |                |         |                |
| Overload  | 110% for 60 min; 125% for 10 min; 150% for 1 min  |         |               |         |         |                |         |                |         |                |
| <b>BATTERIES</b>                                    |   |         |               |         |         |                |         |                |         |                |
| Type  | VRLA AGM/GEL/NiCd/Li-ion/SuperCaps  |         |               |         |         |                |         |                |         |                |
| Recharging method                                   | One level, Two level, Cyclic recharge (selectable)  |         |               |         |         |                |         |                |         |                |
| Battery arrangement (parallel systems)              | Separate/Common   |         |               |         |         |                |         |                |         |                |
| <b>OVERALL SPECIFICATIONS</b>                       |   |         |               |         |         |                |         |                |         |                |
| Weight [kg]   | 850   | 850     | 1010          | 1065    | 1300    | 1520           | 1670    | 2500           | 2830    | 3950           |
| Dimensions (WxDxH) [mm]                             | 800x850x1900  |         | 1000x850x1900 |         |         | 1500x1000x1900 |         | 2100x1000x1900 |         | 3200x1000x1900 |
| Remote signals                                      | 1x opto insulated Input and 3x relays Outputs   |         |               |         |         |                |         |                |         |                |
| Auxiliary signals                                   | R.E.P.O. - External manual bypass - External output switch  |         |               |         |         |                |         |                |         |                |
| Communication                                       | UPS status LEDs - Graphic display - 2 slots for communications interface - 2x RS232   |         |               |         |         |                |         |                |         |                |
| Ambient temperature for the UPS                     | 0 °C - +40 °C   |         |               |         |         |                |         |                |         |                |
| Recommended temperature for battery life            | +20 °C - +25 °C   |         |               |         |         |                |         |                |         |                |
| Range of relative humidity                          | 5-95% non-condensing  |         |               |         |         |                |         |                |         |                |
| Colour  | RAL 7016  |         |               |         |         |                |         |                |         |                |
| Noise level at 1 m [dBA ±2] ECO Mode                | 65  | 68      |               |         |         | 72             |         |                |         |                |
| IP rating   | IP20  |         |               |         |         |                |         |                |         |                |
| ECO Mode efficiency                                 | up to 99%   |         |               |         |         |                |         |                |         |                |
| Standards   | European directives: LV 2014/35/EU low voltage Directive EMC 2014/30/EU electromagnetic compatibility Directive Standards: Safety IEC EN 62040-1; EMC IEC EN 62040-2; RoHS compliant Classification in accordance with IEC 62040-3 (Voltage frequency Independent) VFI - SS - 111 |         |               |         |         |                |         |                |         |                |
| Moving the UPS                                      | Pallet jack   |         |               |         |         |                |         |                |         |                |

<sup>1</sup> For wider tolerance conditions apply.



| MODELS  | MSB 800  | MSB 1200       | MSB 1600       | MSB 2000       | MSB 3000       |
|---|--|----------------|----------------|----------------|----------------|
| <b>OPERATING SPECIFICATIONS</b>                 |  |                |                |                |                |
| Nominal power [kVA]                             | 800  | 1200           | 1600           | 2000           | 3000           |
| Rated voltage [V]                               | 380 / 400 / 415 three-phase + N  |                |                |                |                |
| Voltage tolerance                               | ±15% (selectable from ± 10% to ±25%)   |                |                |                |                |
| Frequency [Hz]                                  | 50 / 60  |                |                |                |                |
| Frequency tolerance                             | ±2% (selectable from ±1% to ±6%)   |                |                |                |                |
| Standard equipment provided                     | Backfeed protection  |                |                |                |                |
| Permitted overload <sup>1</sup>                 | 110% for 60 min; 125% for 10 min; 150% for 1 min   |                |                |                |                |
| <b>OVERALL SPECIFICATIONS</b>                   |  |                |                |                |                |
| Weight [kg]                                     | -  | 800            | 1100           | 1200           | 2000           |
| Weight SW <sup>2</sup> version [kg]             | 570  | 1000           | 1610           | -              | -              |
| Dimensions (WxDxH) [mm]                         | -  | 1400x1000x1900 | 2200x1000x1900 | 2200x1000x1900 | 3600x1000x1900 |
| Dimensions SW <sup>2</sup> version (WxDxH) [mm] | 1000x1000x1900   | 1800x1000x1900 | 3000x1000x1900 | -              | -              |
| Remote signals                                  | 1x opto insulated Input and 3x relays Outputs  |                |                |                |                |
| Auxiliary signals                               | R.E.P.O. - External manual bypass - External MSB output switch - External system output switch   |                |                |                |                |
| Communications                                  | MSB status LEDs - Graphic display - 2 slots for communications interface - 2x RS232  |                |                |                |                |
| Ambient temperature for the MSB                 | 0 °C - +40 °C  |                |                |                |                |
| Recommended temperature for battery life        | +20 °C - +25 °C  |                |                |                |                |
| Range of relative humidity                      | 5-95% non-condensing   |                |                |                |                |
| Colour  | RAL 7016   |                |                |                |                |
| Noise level at 1 m [dBA ±2]                     | <65  |                |                |                |                |
| IP rating                                       | IP20   |                |                |                |                |
| Standards                                       | European directives: LV 2014/35/EU low voltage Directive EMC 2014/30/EU electromagnetic compatibility Directive Standards: Safety IEC EN 62040-1; EMC IEC EN 62040-2; RoHS compliant |                |                |                |                |
| Moving the UPS                                  | Pallet jack  |                |                |                |                |

<sup>1</sup> Conditions apply.

<sup>2</sup> SW version includes input, output and manual bypass switches.



INDUSTRY



TRANSPORT

# Master Industrial



ONLINE



Tower

Service  
1st start**3:1** 30-80 kVA  
220 VDC BUS

## HIGHLIGHTS

- **220 VDC bus voltage**
- **Galvanic isolation of input and output**
- **High short circuit current**
- **Redundant ventilation**

### INDUSTRIAL APPLICATION PROTECTION

Master Industrial series UPS provide maximum protection and power quality for any type of load, especially industrial applications, such as manufacturing and petrochemical processes, electrical distribution and power plants.

Master Industrial is an ON LINE double conversion UPS (class VFI SS 111 in accordance with IEC EN 62040-3) with input and output isolation transformers.

### INDUSTRIAL ENVIRONMENT

Master Industrial is suitable for the most demanding installation environments where there are vibrations, mechanical stresses, dust and in general where the operating conditions are unfavourable to products created for the standard UPS market.

### HIGH ICC

The high short circuit current (ICC = 3xIn)

makes it suitable for loads that require high current peaks during switch-on or during normal operation.

### DC VOLTAGE 220 V

The input and inverter transformers guarantee the isolation of the batteries, which are sized for a voltage of 220 Vdc (from 108 to 114 elements), the standard industrial value.

### REDUNDANT VENTILATION

Redundant ventilation at 100% load is standard, ensuring operation with a normal load with half of the fans operating; in addition, each fan is monitored and an alarm signal is provided in the event of failure. The Easy Source input features, the Battery Care System and the flexibility and communications capabilities are the same as those of the conventional Master MPS range.



## OPTIONS

### SOFTWARE & ACCESSORIES

See Master MPS

### PRODUCT ACCESSORIES

Battery temperature sensor  
Isolation transformer  
Synchronisation device (UGS)

Hot connection device (PSJ)

Parallel kit

Empty battery cabinets or for extended runtimes

Top Cable Entry cabinet

IP rating IP21, IP31/IP42 on request

## DIMENSIONS

MIM 30  
MIM 40

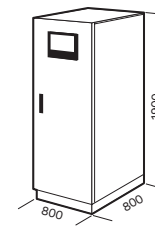

MIM 60  
MIM 80

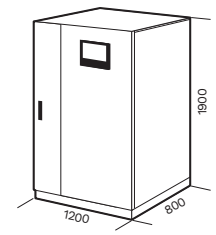

| MODELS  | MIM 30  | MIM 40 | MIM 60        | MIM 80 |
|---|---|--------|---------------|--------|
| <b>INPUT</b>  |   |        |               |        |
| Rated voltage [V]                                   | 380 / 400 / 415 three-phase   |        |               |        |
| Voltage tolerance [V]                               | 400 ±20% @ full load <sup>1</sup>   |        |               |        |
| Frequency [Hz]                                      | 45 - 65   |        |               |        |
| Power factor  | >0.93   |        |               |        |
| Current distortion                                  | <6%   |        |               |        |
| Soft start  | 0 - 100% in 120 s (selectable)  |        |               |        |
| Permitted frequency tolerance                       | ±2% (selectable from ±1% to ±5%)  |        |               |        |
| Standard equip. provided                            | Backfeed protection; separable bypass line; battery isolation   |        |               |        |
| <b>BYPASS</b>                                       |   |        |               |        |
| Rated voltage [V]                                   | 220 / 230 / 240 single-phase + N  |        |               |        |
| Rated frequency [Hz]                                | 50 or 60 (selectable)   |        |               |        |
| Permitted frequency tolerance                       | ±2% (selectable from ±1% to ±5%)  |        |               |        |
| Standard equipment provided                         | Backfeed protection; separable bypass line  |        |               |        |
| <b>OUTPUT</b>                                       |   |        |               |        |
| Nominal power [kVA]                                 | 30  | 40     | 60            | 80     |
| Active power [kW]                                   | 24  | 32     | 48            | 64     |
| Rated voltage [V]                                   | 230 single-phase  |        |               |        |
| Static stability                                    | ±1%   |        |               |        |
| Dynamic stability                                   | EN 62040-3 class performance 1 non-linear load  |        |               |        |
| Voltage distortion                                  | <1% with linear load / <3% with non-linear load   |        |               |        |
| Frequency [Hz]                                      | 50 or 60 (selectable)   |        |               |        |
| Crest factor [I <sub>peak</sub> /I <sub>rms</sub> ] | 3:1   |        |               |        |
| Overload  | 110% for 60 min; 125% for 10 min; 150% for 1 min  |        |               |        |
| Short circuit current                               | 3x I <sub>n</sub>   |        |               |        |
| <b>BATTERIES</b>                                    |   |        |               |        |
| Type  | VRLA AGM / GEL; NiCd  |        |               |        |
| Number of cells                                     | 108/114   |        |               |        |
| Maximum charging voltage [V]                        | 274   |        |               |        |
| <b>OVERALL SPECIFICATIONS</b>                       |   |        |               |        |
| Weight [kg]   | 615   | 630    | 825           | 1030   |
| Dimensions (WxDxH) [mm]                             | 800x800x1900  |        | 1200x800x1900 |        |
| Remote signals                                      | 1x opto insulated Input and 3x relays Outputs   |        |               |        |
| Auxiliary signals                                   | R.E.P.O. - External manual bypass - External output switch  |        |               |        |
| Communications                                      | UPS status LEDs - Graphic display - 2 slots for communications interface - 2x RS232   |        |               |        |
| Ambient temp. for the UPS                           | 0 °C - +40 °C   |        |               |        |
| Recommended temp. for battery life                  | +20 °C - +25 °C   |        |               |        |
| Range of relative humidity                          | 5-95% non-condensing  |        |               |        |
| Colour  | RAL 7035  |        |               |        |
| Noise level at 1 m [dBA ±2] ECO Mode                | 64 - 68   |        |               |        |
| Ventilation   | Redundant fans (front-top)  |        |               |        |
| IP rating   | IP20  |        |               |        |
| ECO Mode efficiency                                 | up to 98%   |        |               |        |
| Standards   | European directives: LV 2014/35/EU low voltage Directive EMC 2014/30/EU electromagnetic compatibility Directive Standards: Safety IEC EN 62040-1; EMC IEC EN 62040-2; RoHS compliant Classification in accordance with IEC 62040-3 (Voltage frequency Independent) VFI - SS - 111 |        |               |        |
| Moving the UPS                                      | Pallet jack   |        |               |        |

<sup>1</sup> For wider tolerance conditions apply

# Master FC400

**3:3** 30-125 kVA



ONLINE



Tower



Service  
1st start

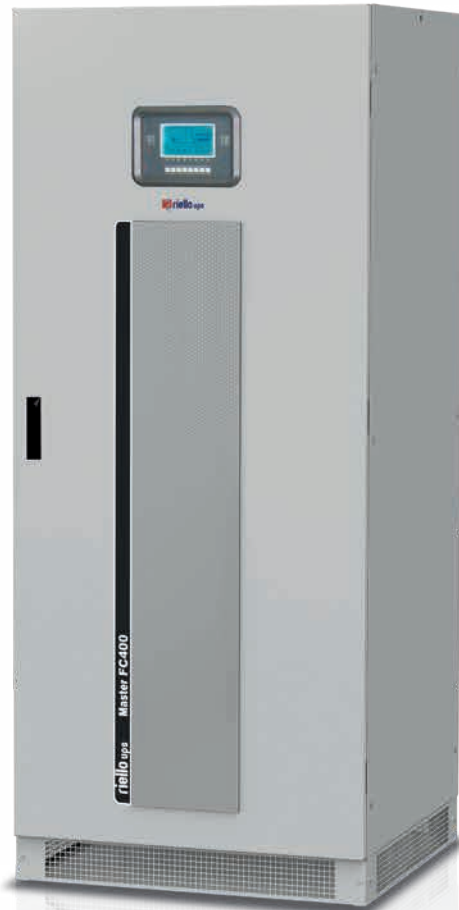

## HIGHLIGHTS

- **Frequency Converter: 50/60 Hz to 400 Hz**
- **Output voltage: 208 V - 3 ph+N**
- **Galvanic isolation**
- **For naval, military and airport applications**
- **Battery backup on request**

Master FC400 series static Frequency Converters are available from 30 to 125 kVA, with 50 or 60 Hz input and 400 Hz output. The result of extensive experience acquired in the UPS industry, the Master FC400 series is distinguished by the use of technologically advanced components and for excellent reliability, ease of maintenance and ease of operation. The Master FC400 series uses double conversion technology (VFI SS 111 voltage and frequency independent compliant with IEC EN 62040-3), with an integrated output transformer to ensure the galvanic isolation of the load from mains disturbances under all conditions. The output voltage is 208 V three-phase (adjustable 200-215 V). Thanks to high frequency IGBT technology and

digital control, Master FC400 Frequency Converters are ideal for airport, military and marine applications.

### MINIMUM IMPACT ON MAINS - EASY SOURCE

The Master FC400 has been designed to minimise the impact on the mains or on the generator located upstream, thanks to the low harmonic content at the input and the progressive start of the rectifier. These features make the Master FC400 Frequency Converters especially compatible with generators.

### EASY INSTALLATION AND MAINTENANCE

The Master FC400 requires a small space for installation (only 0.64 m<sup>2</sup> for a 125 kVA model). The main assemblies of the UPS

can be easily accessed for maintenance, via the removable front panel. Fans located in the top of the UPS cabinet, eliminate the need for side or rear access and allow the UPS to be placed against a wall.

- Powering airplanes in airports
- Radar and flight-control systems
- Naval applications
- Military applications
- Power for test benches.

### APPLICATIONS

Master FC400 provides additional protection for a wide range of applications, including:

### BATTERY BACK-UP

MFC is also available as UPS with battery back-up on request.

## OPTIONS

### SOFTWARE & ACCESSORIES

See Master MPS

### PRODUCT ACCESSORIES

Isolation transformer  
 IP rating IP21, IP31/IP42 on request  
 Parallel kit  
 12 pulse rectifier version (D)  
 5th or 11th harmonic filter (HC)  
 Top Cable Entry cabinet

## DIMENSIONS

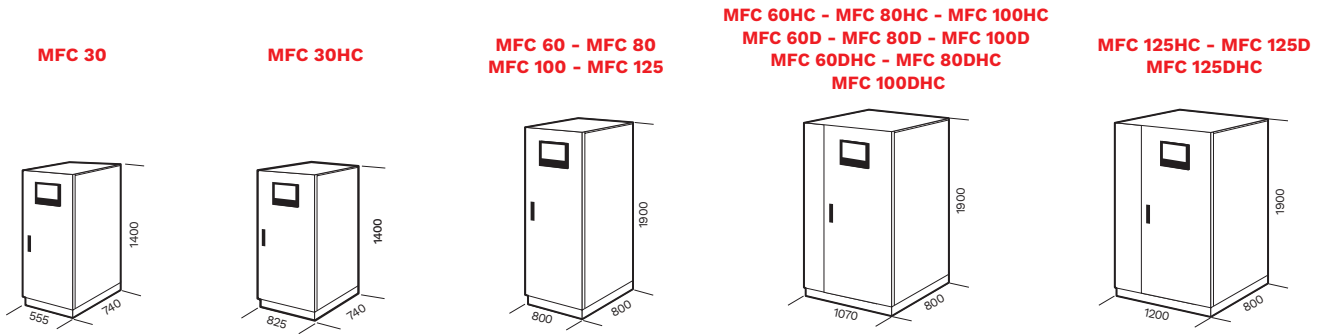

| MODELS  | MFC 30  | MFC 60       | MFC 80 | MFC 100 | MFC 125 |
|---|---|--------------|--------|---------|---------|
| <b>INPUT</b>  |   |              |        |         |         |
| Rated voltage [V]                                   | 380 / 400 / 415 three-phase   |              |        |         |         |
| Voltage tolerance [V]                               | 400 ±20% @ full load <sup>1</sup>   |              |        |         |         |
| Frequency [Hz]                                      | 45 - 65   |              |        |         |         |
| Current distortion                                  | <5% (HC Version)  |              |        |         |         |
| Soft start  | 0 - 100% in 120 s (selectable)  |              |        |         |         |
| <b>OUTPUT</b>                                       |   |              |        |         |         |
| Nominal power [kVA]                                 | 30  | 60           | 80     | 100     | 125     |
| Active power [kW]                                   | 24  | 48           | 64     | 80      | 100     |
| Number of phases                                    | 3 + N   |              |        |         |         |
| Rated voltage [V]                                   | 208 <sup>1</sup> three-phase + N  |              |        |         |         |
| Static stability                                    | ±1%   |              |        |         |         |
| Dynamic stability                                   | ±5%   |              |        |         |         |
| Voltage distortion                                  | <3% with linear load / <4% with non-linear load   |              |        |         |         |
| Frequency [Hz]                                      | 400   |              |        |         |         |
| Crest factor [I <sub>peak</sub> /I <sub>rms</sub> ] | 3:1   |              |        |         |         |
| Overload  | 110% for 60 min; 125% for 10 min; 150% for 1 min  |              |        |         |         |
| <b>OVERALL SPECIFICATIONS</b>                       |   |              |        |         |         |
| Weight [kg]   | 265   | 450          | 535    | 540     | 560     |
| Dimensions (WxDxH) [mm]                             | 555x740x1400  | 800x800x1900 |        |         |         |
| Remote signals                                      | 1x opto insulated Input and 3x relays Outputs   |              |        |         |         |
| Auxiliary signals                                   | R.E.P.O. - External output switch   |              |        |         |         |
| Communications                                      | Status LEDs - Graphic display - 2 slots for communications interface - 2x RS232   |              |        |         |         |
| Ambient temperature for the UPS                     | 0 °C - +40 °C (50 °C @ 75% load)  |              |        |         |         |
| Recommended temp. for battery life                  | +20 °C - +25 °C   |              |        |         |         |
| Range of relative humidity                          | 5-95% non-condensing  |              |        |         |         |
| Colour  | RAL 7035  |              |        |         |         |
| Noise level at 1 m [dBA ±2] ECO Mode                | 62 - 68   |              |        |         |         |
| IP rating   | IP20  |              |        |         |         |
| Standards   | European directives: LV 2014/35/EU low voltage Directive EMC 2014/30/EU electromagnetic compatibility Directive Standards: Safety IEC EN 62040-1; EMC IEC EN 62040-2; RoHS compliant Classification in accordance with IEC 62040-3 (Voltage frequency Independent) VFI - SS - 111 |              |        |         |         |
| Moving the UPS                                      | Pallet jack   |              |        |         |         |

<sup>1</sup> For wider tolerance conditions apply.

# Multi Power



ONLINE



Modular



Hot swap  
battery



Lithium  
compatible



SmartGrid  
ready



USB  
plug



**3:3** 15-240 kW  
+ redundancy  
25-400 kW  
+ redundancy  
42-1008 kW  
+ redundancy

## HIGHLIGHTS

- **Utmost availability**
- **Ultimate scalability**
- **Unmatched power density**
- **Efficiency >96.6%**
- **Multiple controls**
- **Highly flexible**
- **Advanced comms**

The Riello UPS Multi Power (MPW and MPX) is the ultimate modular UPS for Data Centers and other CRITICAL LOADS.

The Multi Power is designed to protect any critical high-density computer and IT environment, whilst achieving maximum availability. The Multi Power grows along with the demands of the business without over-sizing the UPS - optimizing both the initial investment and the Total Cost of Ownership. As soon as demand increases, the Riello UPS Multi Power modular solution can expand its power capability, maintaining the highest levels of power protection, availability, redundancy and investment savings.

Digital technology has an increasingly strong influence on day-to-day activities in almost all sectors and applications

such as healthcare, power generation, social networking, telecommunications, commerce and education.

Subsequently, any activities and equipment related to data storage, processing and transfer should be supplied from the most reliable power source. Multi Power ensures that a scalable, secure, high quality power supply is available for a variety of critical load applications. The new MPW and MPX Power Modules feature the very latest in UPS technology. With its three-level Neutral Point Clamped (NPC) inverter and Power Factor Corrected (PFC) input control, the Multi Power ensures the highest level of performance in terms of overall efficiency, input power factor and harmonic impact on the supply source.





## ADVANCED TECHNOLOGY

To ensure the highest levels of power availability, only the most reliable, cutting edge power components and innovative control technologies have been used in the development of the MPW and MPX power modules and other major aspects of the system. The major power components and assemblies within the Multi Power have been specifically designed and tailor made in conjunction with the respective component manufacturers. This design work ensures that the Multi Power achieves the highest levels of power and performance. In order to optimise the overall performance of the finished product, Riello UPS' R&D team made the decision to specifically design certain power components, including the IGBT modules and associated packages. Rather than using standard components that are readily available in the marketplace, the Multi Power hosts one single optimised and reliable power assembly which guarantees the best availability and overall efficiency. The Power Module itself utilises a "wireless power principle" meaning that the power interconnection distances between the cards, power components and connectors are shorter. In this way we reduce any risk related to connection problems between the assemblies and also minimise the overall power losses.

## SCALABILITY

Multi Power provides a comprehensive, easy to integrate power protection solution for Data Centers and any critical IT application matching the evolving demands of a networked environment. The end user can easily increase power, redundancy level and battery autonomy by simply adding additional UPS **Power Modules (PM)** and **Battery Units (BU)**. Three different cabinets are available to build the system: the **Power Cabinets (MPW and MPX type)** and the **Battery Cabinet (BTC)**. The Power Cabinets can accommodate either 15 kW (MPX 15 PM), 25 kW (MPX 25 PM) or 42 kW Power Modules (MPW 42 PM). The available UPS power and redundancy level can expand vertically from:

- 15 to 75 kW in one single Power Cabinet (MPX 130 PWC with MPX 15 PM)
- 25 to 125 kW in one single Power Cabinet (MPX 130 PWC with MPX 25 PM)
- 42 to 294 kW in one single Power Cabinet (MPW 300 PWC with MPW 42 PM).

Up to four complete Power Cabinets can be connected in parallel, increasing the capacity including redundancy respectively from:

- 75 up to 300 kW (with MPX 15 PM)
- 125 up to 500 kW (with MPX 25 PM)
- 294 up to 1176 kW (with MPW 42 PM)

The Battery Cabinet accommodates multiples of 4 Battery Units, with up to 36 units within a single frame with

a maximum of 10 Battery Cabinets connected in parallel.

In addition, the Multi Power is available as optimised solution providing a Multi Power/Battery combination with the **Combo Cabinet (MPW and MPX type)**. This solution can be utilised within extremely compact areas requiring a small footprint with maximum power density. This modular and reliable solution is perfect for any small to medium business applications.

The user might decide to build the Combo solution using three different cabinets:

- MPX 75 CBC cabinet has three slots for PMs and three battery shelves and it can expand vertically from: 15 to 45 kW (with MPX 15 PM) or 25 to 75 kW (with MPX 25 PM);
- MPX 100 CBC cabinet has four slots for PMs and six battery shelves and it can expand vertically from: 15 to 60 kW (with MPX 15 PM) or 25 to 100 kW (with MPX 25 PM);
- MPW 130 CBC cabinet has three slots for PMs and five battery shelves and it can expand vertically from: 42 to 126 kW (with MPW 42 PM).

## OUTSTANDING PERFORMANCES

- The advanced technologies deployed within the Multi Power guarantee full rated power even with unity power factor loads (kVA=kW) without any power downgrading even when operating at temperatures up to 40 °C.



Power Cabinet MPW 300 PWC (1-7x MPW 42 PM) x 4



Power Module 15 kW - MPX 15 PM  
Power Module 25 kW - MPX 25 PM



Power Module 42 kW - MPW 42 PM



Battery Unit Array - 4x BU

- High system efficiency whilst operating in ON LINE double conversion mode greater than 96.5%. Even when loaded at only 20%, the Multi Power still achieves an outstanding performance greater than 95%. This superior performance ensures extremely low losses at any load level whilst maintaining a true modular solution for any changing UPS environment in terms of power demands.
- Low input harmonic pollution, with near unity input power factor and an extremely wide input voltage operating range (+20/-40%), requiring only a minimum upstream power source rating and subsequent reduced investment costs.

### MULTIPLE CONTROLS

The entire Multi Power solution was developed with particular care to ensure operational reliability and prevent any possible failures due to miscommunication between the component parts of the system. The Power Modules are not controlled by one unique microprocessor, but by three - each having different and specific duties. Likewise, the Power Cabinet features two separate microprocessors; one to regulate the overall UPS operations and a separate one to manage communication with the user. In addition, three dedicated communications bus manage and transmit the data. In terms of the monitoring and control of the overall system, all major components are continually temperature monitored within each of the Power Modules. In addition, up to four-temperature sensors are embedded within the Power Cabinet to ensure constant and efficient operation. The Power Module is equipped with three speed controlled fans to ensure there is no energy wasted as the load level applied to the system increases or decreases. At the same time each fan features a so-called third wire (the controller) which immediately warns the microprocessor in the event of a fault; in which case the microprocessor will increase the speed of the remaining operational fans in order to compensate for the cooling deficiency. The Battery Unit also contains dedicated internal protection and a sophisticated control system to monitor the status of each module. This makes it possible to check the voltage/current supplied by each single battery module and therefore identify and warn the user if one of them is defective or beginning to fail. This significantly reduces the risk of a battery pack failure causing a problem to the system by immediately warning the user

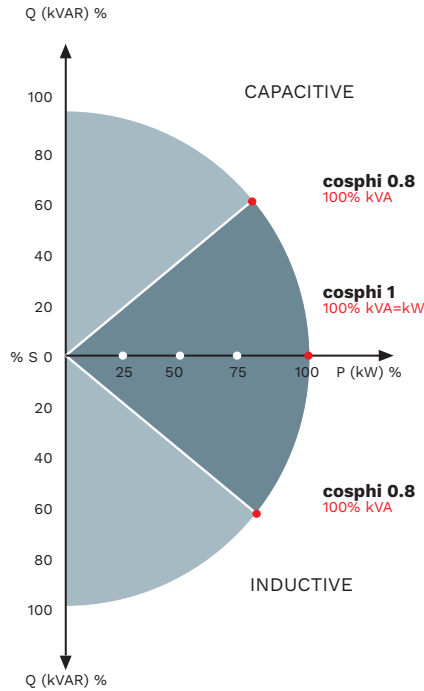

of the impending issue in order for the appropriate preventive actions to be taken before it is too late.

### FLEXIBLE MODULARITY

Multi Power grows both vertically and horizontally from 1 to 20 Power Modules (MPX 15 PM/MPX 25 PM) or 1 to 28 Power Modules (MPW 42 PM) up to 1176 kW (including redundancy) as well as battery units (from 1 cabinet, up to 10), therefore the system is completely scalable in accordance with any business requirements. The Plug & Play modular concept simplifies any power or battery autonomy expansion process, rather than a complete Power Module or Battery unit replacement. The modular hot-swappable principle is further extended to all major elements of the system, resulting in convenient replacement of parts such as fans from within individual Power Modules rather than accessing major components within the cabinet. Furthermore, all Power Modules and critical components are easily accessible from the front of the



*Combo Cabinet MPX 100 CBC  
(1-4 MPX 15 PM or MPX 25 PM)  
+ 1-6 Battery shelves.*

*Combo Cabinet MPW 130 CBC  
(1-3x MPW 42 PM) + 1-5 Battery Shelves  
with front door air filter  
(optional available on all cabinet types).*





Battery Cabinet (MPW 170 BTC) with open and closed door.



Combo Cabinet MPX 75 CBC (1-3 MPX 15 PM or MPX 25 PM) + 1-3 Battery shelves.



Power Cabinet MPX 130 PWC (1-5x MPX 15 PM or MPX 25 PM).

unit as standard. The system is equipped with a Manual Bypass change over switch and Backfeed control with a mechanical interlock contactor inbuilt, eliminating any maintenance-related downtime (inbuilt contactor is optional for MPX 130 PWC, MPX 75 CBC and MPX 100 CBC). Combination systems (Combo Cabinet) and Battery Cabinet are supplied with a battery switch and shunt trip to enable remote battery switch operation (battery switch not available for MPX 75 CBC). All these features ensure easy UPS expansion, operation and maintenance; minimizing downtime, decreasing the Mean Time to Repair (MTTR) and removing any possible risk to power continuity, when carried out by authorised service personnel. Flexibility is measured by the ease of both on site installation and the operations undertaken by the user. Input/Output/battery terminal bars are deployed enabling authorised installers to easily terminate the cables either from the top or the bottom of the system (for MPX 130 PWC and MPX 75 CBC bottom entry only). Mechanical supports and cable glands as well as the terminal bar positioning (in the center of the cabinet) are purposely positioned to reduce the installation time and costs. In addition, in terms of flexibility of the battery installation, whether a conventional or modular type system is implemented these can be arranged in two different configurations: centralised (common battery) or distributed (separate battery

for each Power/Combo Cabinet). This will ensure the highest level of adaptability for any critical installation and/or economical driving factors.

#### TURNKEY SOLUTIONS

User may deploy Multi Power cabinets lining up four Cabinets one to each other and arranging locally for input and output cabling. Riello UPS offers as alternative a 500 kVA turn-key solution which consist in two Power Cabinets (MPW 300 PWC) and a Switching Cabinet to tie up the two. It includes AC input/output terminals for site power distribution connection, related joining flexible bars and communication links between Power Cabinets and Switching Cabinet. Switching Cabinet is also supplied with AC input/output/bypass lines breakers as well as with an integral wrap around maintenance bypass. Bypass line is protected with fuses to grant fault discrimination and load protection in case of short circuit downstream. The breaker set enables to galvanically insulate the single Power Cabinets and to carry out specific maintenance. Switching Cabinet cable entry is arranged so that user may decide either to access from the bottom front, rear side or top. This on hand solution simplify the installation activity and contribute to the overall TCO reduction minimizing, upfront, installation and operating costs.

#### ADVANCED COMMUNICATIONS

Users can benefit from the different communication systems developed specifically for IT personnel, facilities managers and service engineers.

The 7" LCD touch screen, communication slots, relay cards along with the dedicated service ports, all ensure that the UPS setup, control and monitoring is easy. The Multi Power LCD touch screen has embedded the follow protocols:

- UDP to communicate with our shutdown software PowerShield<sup>3</sup>
- HTTP and HTTPS to monitor the UPS status using a standard web browser without any additional software.
- SMTP to send emails related to the UPS status, alarms and a power quality daily and weekly report.

In addition, with the network card NetMan 208, Multi Power can be integrated into any building management system and Data Center infrastructure (DCIM) with the protocols:

- SNMP v1, v2 and v3.
- Modbus/TCP.

Multi Power is compatible with the very latest operating systems including Windows 11, 10, 8, Server 2022, 2019, 2016 and previous versions, Windows Server Virtualization Hyper-V, macOS, Linux, Citrix XenServer and other Unix operating systems.

**MPX 130 PWC**

**MPX Power Cabinet**  
15-75 kW or 25-125 kW  
(front)

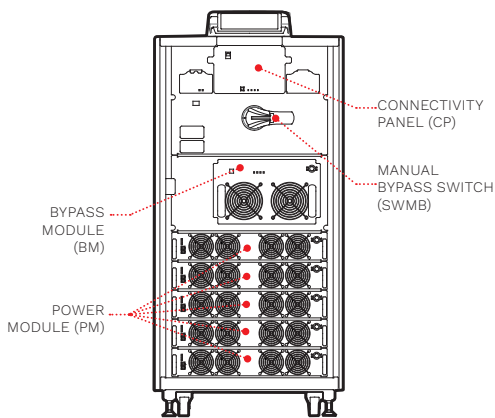

**MPX 130 PWC**

**MPX Power Cabinet**  
15-75 kW or 25-125 kW  
(rear)

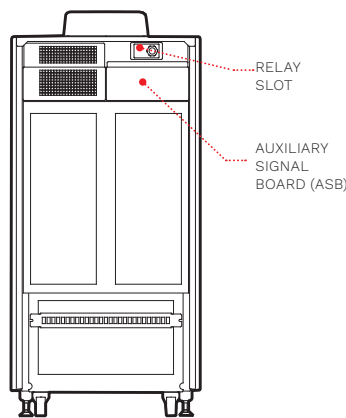

**MPW 170 BTC**

**MPW Battery Cabinet**  
(front)

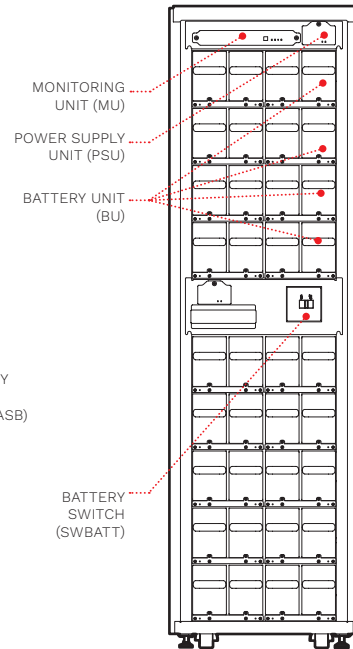

**MPW 300 PWC**

**MPW Power Cabinet**  
42-294 kW  
(front)

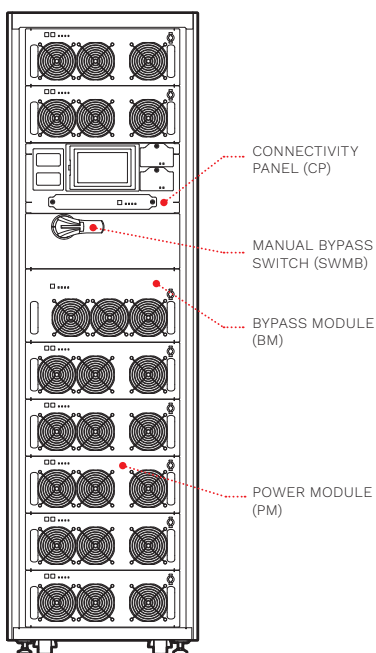

**MPW 300 PWC**

**MPW Power Cabinet**  
42-294 kW  
(rear)

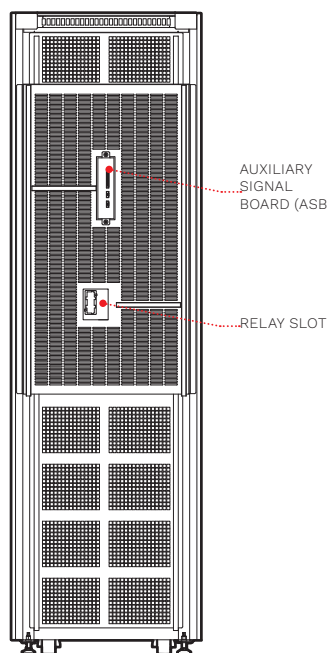

**MPW 170 BTC**

**MPW Battery Cabinet**  
(front)

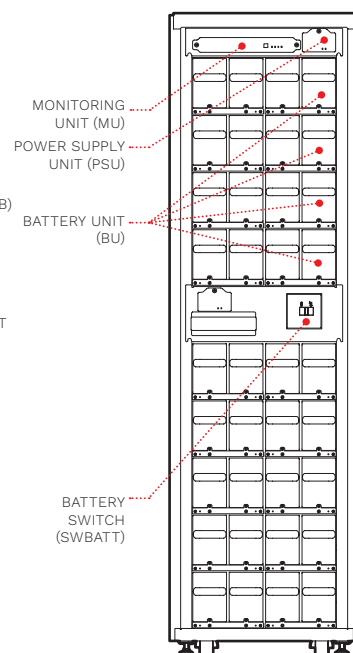

**MPW 130 CBC**  
**MPW Combo Cabinet**  
**42-126 kW**  
**(front)**

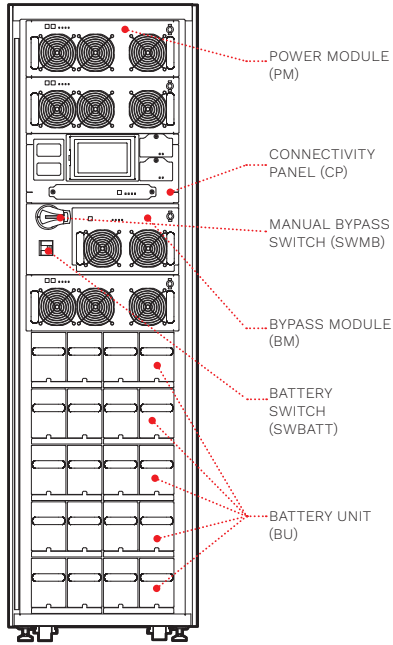

**MPW 130 CBC**  
**MPW Combo Cabinet**  
**42-126 kW**  
**(rear)**

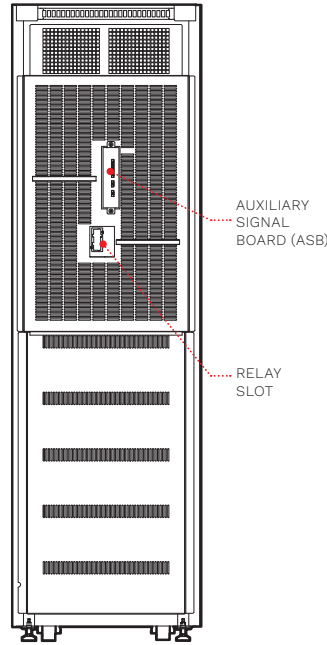

**MPW 170 BTC**  
**MPW Battery Cabinet**  
**(front)**

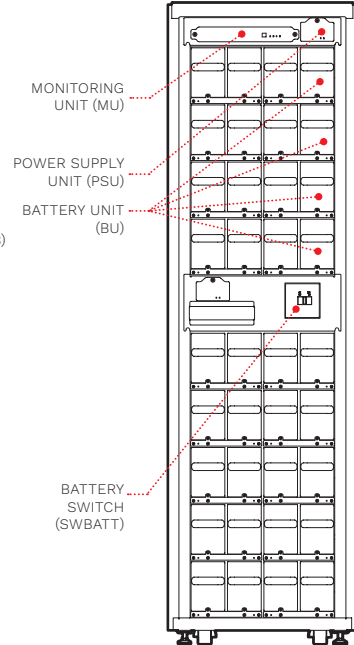

**MPW Switching Cabinet 500**  
**+ 2x MPW 300 PWC**  
**(front without doors)**

**MPW Switching Cabinet 500**  
**+ 2x MPW 300 PWC**  
**(rear without panels)**

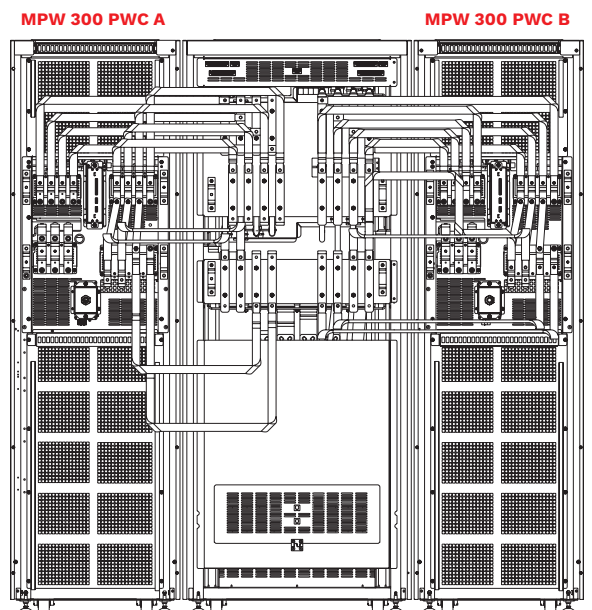
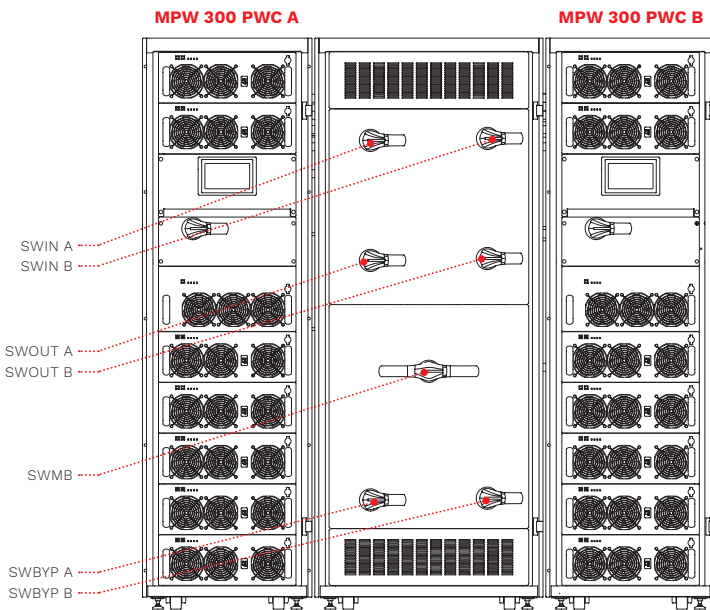

## DETAILS

### Auxiliary Signal Board (ASB)

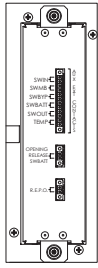

### Connectivity Panel (CP)

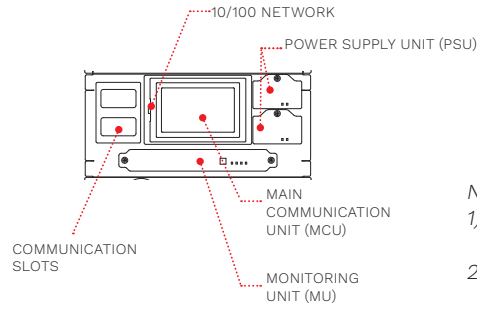

Note:  
 1) On MPX 130 PWC connectivity panel layout is different.  
 2) Second PSU on MPX 130 PWC is optional.

## BATTERY CABINETS

| MODELS          | MPW BATTERY CABINET / MPW 170 BTC<br>(MODULAR BATTERY CABINET) | BTC 2000 480V BB V6 3T / BTC 2000 480V BB V7 3T<br>BTC 2000 480V BB V8 3T / BTC 2000 480V BB V9 3T<br>BTC 2000 480V AB V9 3T<br>(CONVENTIONAL BATTERY CABINET) |
|-----------------|--|--|
| UPS MODELS      | Select the Battery configuration according Multi Power range   |  |
| Dimensions [mm] |  |  |

## OPTIONS

### SOFTWARE

PowerShield<sup>3</sup>  
 PowerNetGuard

### ACCESSORIES

NETMAN 208  
 MULTICOM 302  
 MULTICOM 352  
 MULTICOM 372  
 MULTICOM 384  
 MULTICOM 411  
 MULTICOM 421  
 MULTI I/O  
 MULTIPANEL

### PRODUCT ACCESSORIES

Battery temperature sensor  
 On front door air filter  
 Parallel Kit  
 IP21 Protection Kit  
 Programmable relay board  
 MULTICOM 392  
 Switching Cabinet  
 Cold Start  
 Seismic kit (MPX 130 PWC)  
 ENERGYMANAGER

| <b>MODEL</b>  | <b>Multi Power - from 15 to 294 kW<sup>1</sup></b>  |                                  |   |   |                                    |
|---|---|----------------------------------|---|---|------------------------------------|
| <b>INPUT</b>  |   |                                  |   |   |                                    |
| Rated voltage [V]                                       | 380 / 400 / 415 three-phase + neutral   |                                  |   |   |                                    |
| Rated frequency [Hz]                                    | 50 / 60   |                                  |   |   |                                    |
| Voltage tolerance [V]                                   | 400 ±20% @ full load <sup>2</sup>   |                                  |   |   |                                    |
| Frequency tolerance [Hz]                                | 40 - 72   |                                  |   |   |                                    |
| Power factor  | 0.99  |                                  |   |   |                                    |
| THDI  | <3%   |                                  |   |   |                                    |
| <b>BYPASS</b>   |   |                                  |   |   |                                    |
| Nominal power [kW]                                      | 252 / 126 (According to system power configuration)   |                                  |   |   |                                    |
| Rated voltage [V]                                       | 380 / 400 / 415 three-phase + neutral   |                                  |   |   |                                    |
| Voltage tolerance [V]                                   | from 180 (adjustable 180-200) to 264 (adjustable 250-264) referring to Neutral  |                                  |   |   |                                    |
| Rated frequency [Hz]                                    | 50 or 60  |                                  |   |   |                                    |
| Frequency tolerance                                     | ±5% (selectable)  |                                  |   |   |                                    |
| Overload  | 125% for 10 min; 150% for 1 min   |                                  |   |   |                                    |
| <b>BATTERIES</b>  |   |                                  |   |   |                                    |
|   | <b>Modular Type (MPW 170 BTC)</b>   |                                  | <b>Conventional Type</b>                            |   |                                    |
| Battery arrangement (parallel systems)                  | Separate/common   |                                  |   |   |                                    |
| Layout  | Modular type made up by Battery Unit (named BU)   |                                  | Free Standing Battery cabinet / Shelf               |   |                                    |
| Battery features  | VRLA batteries lined up inside BU; Constant voltage and current measuring at BU level; Battery status monitoring via Multi Power LCD display  |                                  | Conventional battery Blocks VRLA Type               |   |                                    |
| Cabinet layout description                              | 9x Battery shelves  |                                  | 1x (20 + 20) Blocks                                 |   |                                    |
| Dimensions (WxDxH) [mm]                                 | 600x1050x2000   |                                  | 860x800x2000  |   |                                    |
| Weight [kg] (without PM <sup>3</sup> /BU <sup>4</sup> ) | 280   |                                  | 250   |   |                                    |
| <b>OUTPUT</b>   |   |                                  |   |   |                                    |
| Rated voltage [V]                                       | 380 <sup>2</sup> / 400 / 415 three-phase + neutral  |                                  |   |   |                                    |
| Rated frequency [Hz]                                    | 50 or 60  |                                  |   |   |                                    |
| Voltage stability                                       | ±1%   |                                  |   |   |                                    |
| Dynamic stability                                       | EN62040-3 class performance 1 non linear load   |                                  |   |   |                                    |
| <b>OVERALL SPECIFICATIONS</b>                           |   |                                  |   |   |                                    |
|   | <b>MPX 130 PWC Power Cabinet</b>  | <b>MPW 300 PWC Power Cabinet</b> | <b>MPX 75 CBC Combo Cabinet</b>                     | <b>MPX 100 CBC Combo Cabinet</b>                    | <b>MPW 130 CBC Combo Cabinet</b>   |
| Cabinet type  |   |                                  |   |   |                                    |
| Power Module nominal power [kW] (Named PM)              | MPX 15 PM<br>MPX 25 PM  | MPW 42 PM                        | MPX 15 PM<br>MPX 25 PM                              | MPX 15 PM<br>MPX 25 PM                              | MPW 42 PM                          |
| Solution nominal Power [kW]                             | 75 / 125  | 294                              | 45 / 75   | 60 / 100  | 126                                |
| Output power factor [pf]                                | 1   | 1                                | 1   | 1   | 1                                  |
| Parallelable (up to)                                    | 4   | 4                                | 4   | 4   | 4                                  |
| Cabinet layout description                              | 5x MPX 15 PM<br>5x MPX 25 PM  | 7x MPW 42 PM                     | 3x MPX 15 PM<br>3x MPX 25 PM<br>+3x Battery shelves | 4x MPX 15 PM<br>4x MPX 25 PM<br>+6x Battery shelves | 3x MPW 42 PM<br>5x Battery shelves |
| Dimensions [WxDxH] [mm]                                 | 600x1050x1200   | 600x1050x2000                    | 600x1050x1600                                       | 600x1050x2000                                       | 600x1050x2000                      |
| Weight [kg] (without PM <sup>3</sup> /BU <sup>4</sup> ) | 145   | 300                              | 190   | 350   | 340                                |
| System Noise Level at 1 m [dBA±2]                       | <65   | <68                              | <63   | <64   | <64                                |
| ECO Mode Efficiency                                     | up to 99%   |                                  |   |   |                                    |
| Cabinet IP rating                                       | IP20 finger proof (either with cabinet doors open or close)   |                                  |   |   |                                    |
| Cable input   | Rear side either top or bottom  |                                  |   |   |                                    |
| Colour  | RAL 9005  |                                  |   |   |                                    |
| Ambient temp. for the UPS                               | 0 °C - +40 °C   |                                  |   |   |                                    |
| Recommended temperature for battery life                | +20 °C - +25 °C   |                                  |   |   |                                    |
| Range of relative humidity                              | 5-95% non-condensing  |                                  |   |   |                                    |
| Standards   | European directives: LV 2014/35/EU low voltage Directive EMC 2014/30/EU electromagnetic compatibility Directive Standards: Safety IEC EN 62040-1; EMC IEC EN 62040-2 - category C2; RoHS compliant Classification in accordance with IEC 62040-3 (Voltage Frequency Independent) VFI - SS - 111 |                                  |   |   |                                    |
| Moving UPS cabinet types                                | Castors (any cabinet type is shipped without PM and BU)   |                                  |   |   |                                    |

<sup>1</sup> Including Redundancy

<sup>2</sup> For wider tolerance conditions apply.

<sup>3</sup> PM = Power Module (either referring to MPX 15 PM, MPX 25 PM or MPW 42 PM)

<sup>4</sup> BU = Battery Unit

NOTE: All performances quoted in a single row refer to any UPS system configuration from one to seven modules running in parallel unless specified differently.

## MULTI POWER EMBEDDED PROTOCOLS

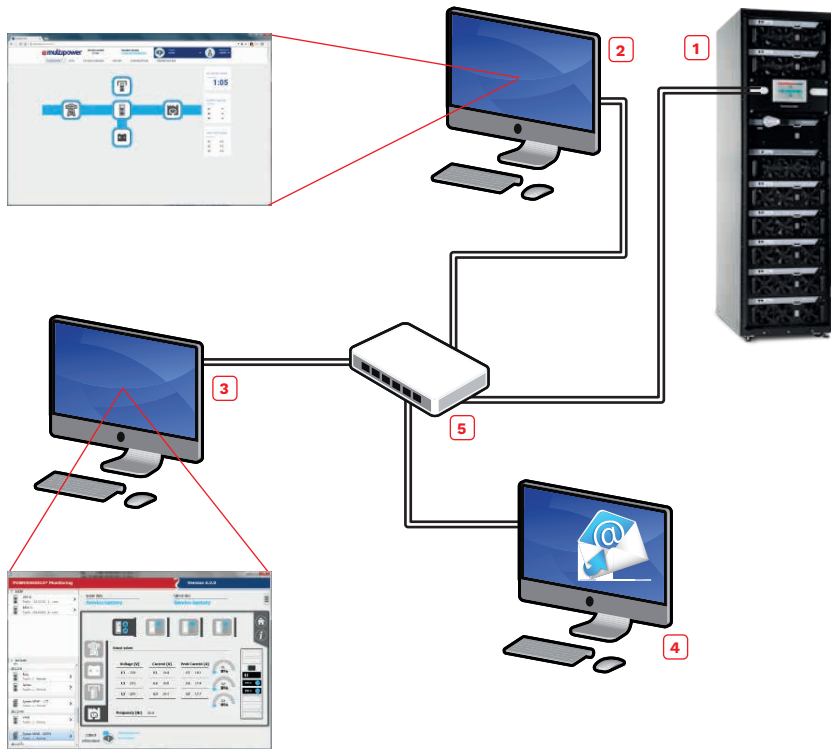

- ..... 1 MPW / MPX
- ..... 2 Web Browser
- ..... 3 PowerShield<sup>3</sup>
- ..... 4 Mail Server
- ..... 5 Ethernet Switch
- ==== Ethernet

## MULTI POWER PROTOCOLS ADDING NETMAN 208 CARD

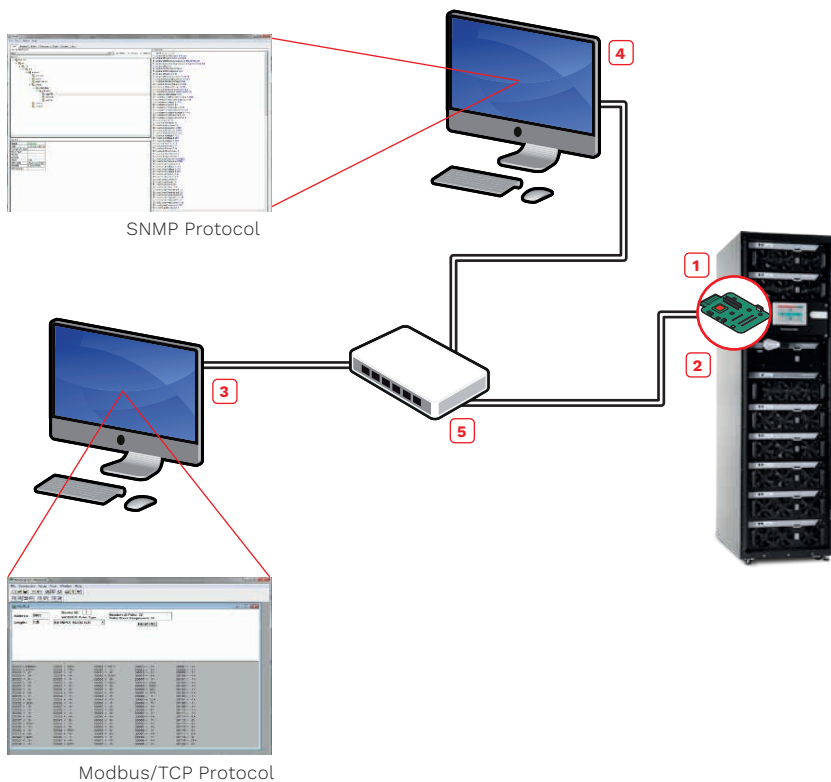

- ..... 1 MPW / MPX
- ..... 2 NetMan 208 board
- ..... 3 Modbus/TCP Manager
- ..... 4 SNMP Manager
- ..... 5 Ethernet Switch
- ==== Ethernet





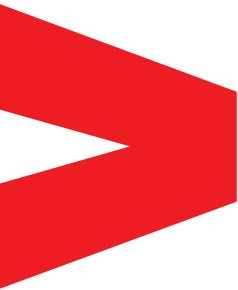

# Multi Power2



DATACENTER



INDUSTRY



TRANSPORT

**3:3** 500-1000-1250-1600 kW



ONLINE



Modular



Lithium compatible



SmartGrid ready



USB plug



## HIGHLIGHTS

- **Ultra-high efficiency**
- **Ultimate availability**
- **Risk-free scalability**
- **Smart Modular Architecture (SMA)**
- **Truly sustainable**

Riello UPS's Multi Power modular range has been efficiently protecting the supply of critical applications around the world for almost a decade. With thousands of power modules deployed across the globe, it is recognised as a high performing and ultra-reliable system.

Treasuring the previous experience and deeply understanding our customers' needs, we conceived a second generation of modular solutions for critical high-density computing environments encompassing small, medium and large data centers, as well as any other critical power application.

Riello Multi Power2 is the evolution of our modular UPS, which aims to offer higher power density, simpler integration to both existing and new installations and last but

not least enhanced operating efficiency and global flexibility to reduce both the upfront investment and the day-to-day operational costs.

It is the result of our efforts to provide a more sustainable, compact and reliable power supply suitable for the most demanding applications, not only in high-density critical IT environments, but wherever energy continuity is a must and has to be ensured without any compromise in terms of performance. Thanks to its modular architecture, the system can be adapted to the load demands to avoid any oversizing and provide the best performance in every working condition.

With a new extremely high-density power module, available in two different models,



our solution reaches up to 1600 kW in a single UPS and up to 6400 kW with 4 systems in parallel.

**EFFICIENT AND SUSTAINABLE**

One of the biggest challenges of our time is sustainability, not only in the Data Center industry but across many other fields, such as healthcare, power generation, telecommunications, trade and education.

This is the reason why we have developed the new best-in-class power module based on the latest silicon carbide technology (SiC), which reduces cooling requirements and allows for more compact, more reliable and more robust solutions.

Our modules reach an efficiency up to 98.1% in ON LINE double conversion, providing the best power supply to critical equipment whilst minimising operating costs and energy losses.

High efficiency is achieved even in case of extremely low loads thanks to EFFICIENCY CONTROL Mode, where our system will automatically activate only the required number of Power Modules, ensuring the highest efficiency and granting, at the same time, the redundancy level requested. Moreover Multi Power2 is able to work in temperatures up to 40 °C (without any derating), minimising the demand and consumption of cooling systems.

Our units deploy such advanced technologies that they offer faster and more reliable communication between all the system parts and achieve outstanding dynamic performances.

**FLEXIBLE AND SCALABLE**

Multi Power2 has been designed to be easy scalable and quickly adaptable to any increase in load, providing a pay-as-you-grow approach that optimises both the initial investment and the TCO (Total Cost of Ownership).

The range consists of:

- MP2 – Multi Power2 up to 500 kW;
- M2S – Multi Power2 Scalable from 1000 kW to 1600 kW.

The MP2 frame can host up to 8 modules while M2S accepts up to 30 modules (according to the cabinet power and the redundancy requirements).

Power Modules are available in two different 67 kW - 3U versions: the standard one (IGBT) can reach a 96.5% efficiency, whereas the BLUE one (SiC) boasts outstanding efficiency of 98.1% in ON LINE Mode.

The modules are designed to be fully independent, hot-swappable, mechanically segregated and with embedded selective disconnection at both the input and output stage. The Bypass is modular and fully rated according to the maximum power of the system (500 kW, 1000 kW, 1250 kW, 1600 kW), enabling it to clear higher short circuit currents.

**SMART MODULAR ARCHITECTURE (SMA)**

Our Smart Modular Architecture (SMA) is the result of a new design approach focused on a deep interconnection between hardware and software. It provides an extremely reactive system which ensures business continuity in every operating condition.

Multi Power2 is a step forward in every part of the system, from the power module to the HMI passing through the cabinet:

- Intelligence is distributed to avoid any single point of failure and ensure the protection of the equipment even on the off chance of a failure.
- Automatic health-checks are performed during the plug-in of each module to verify its status and avoid defective components. Operation is completely risk-free and enables the user to increase the power or redundancy of the system while the UPS is protecting the



Power Module 67 kW (IGBT) - MP2 67 PM.



Power Module 67 kW (SiC) MP2 67 PM BLUE.

load. If a module has a different firmware version, the system aligns it to one of the other modules.

- Comprehensive upgrade of the firmware can be performed while the unit is working in ON LINE double conversion.
- Continuous monitoring is possible thanks to the several sensors embedded in each module: they allow the user to check the status of the UPS and analyse the running and environmental parameters to ensure the best operating performances. This helps to identify specific predictive maintenance services based on the actual working conditions.
- Embedded interleaving technology grants a significant reduction of the ripple current values and extends the lifespan of the batteries and DC capacitors.

**RELIABLE AND RESILIENT**

The Multi Power2 is extremely reliable as it is designed to avoid any single point of failure. This principle is applied

**98%**

**Efficiency**

ON LINE double conversion

=



**18 tons**

of CO<sub>2</sub> saved



**12 k€**

energy bill savings

Yearly values calculated for MP2 500 kW UPS with BLUE modules compared to 96% efficiency UPS, considering 50% average load, cooling COP=3, 0.3 kg CO<sub>2</sub> & 0.2 € per kWh

to all the parts of the unit, even to the internal communication structure, which is completely redesigned and now made by two separate and fully redundant high-speed buses. To provide the highest level of quality and process control, each component of the system, from the modules to the cabinet, is designed and manufactured in Italy; moreover, all component suppliers are carefully selected through a strict process of approval. At the end of our production line, all modules and full units undergo specific tests to verify that each component operates correctly.

All collected measurements and data are analysed to keep improving our products and provide our customers with the most updated technologies.

To enhance the lifespan of the UPS, each module incorporates status counters, as well as temperature and humidity sensors, providing real-time analytics for operators.

### EXTREMELY FLEXIBLE

The Multi Power2 has been conceived to be fully customisable to meet the specific needs of each installation and quickly adapt to the load increase.

Thanks to the hot-swappable features, the increase of power can be done while the unit is working in ON LINE double conversion without any disruption to the load.

All the major components of the UPS are modular and can be easily added and/or replaced by the engineer, minimising the site intervention cost and avoiding any downtime.

The Multi Power2 is available in many configurations and frames:

- **PCM:** very compact solution with integrated manual bypass.
- **PCO:** unit supplied with unique I/O and without switches to simplify the integration with the existing electrical infrastructure and to meet any space constraints.

- **PCS:** fully integrated, for a complete, simple and very reliable installation, with main input, bypass, manual bypass and output switches.

The units have been designed with several standard features:

- Top or bottom cable entry;
- Air filter;
- Fans monitoring;
- Backfeed detection circuit and protection;
- EFFICIENCY CONTROL Mode;
- ACTIVE ECO Mode;
- Power walk-in;
- Separate or common batteries;
- Compatibility with several storage technologies: VRLA, Li-Ion, NiCd, Supercaps;
- Smart grid ready.

A full set of options is available to fit the requirements of each installation, in both IT and non-IT environment:

- Parallel kit;
- Cold start kit;
- Internal backfeed protection device;
- Bottom cable entry for MP2 500;
- Overall coating treatments;
- IP 31 protection;
- Power bars Thermoscan;
- Connection cabinet (2x MP2 500);
- Synchronisation device (UGS);
- Hot connection device (PSJ).

### USER FRIENDLY

The Multi Power2 is equipped with a 10" colour touch screen display that simultaneously provides information, measurements and operating states of the entire system and of each individual power module. The user interface also includes a LED bar which delivers immediate and clear information regarding the current status of the UPS. To ensure a simple, quick and full connection to the existing infrastructure, by default all Multi Power2 units are equipped with:

- network card NetMan 208;
- embedded configurable In/Out signals



### Best in class footprint

500 kW in just 0.52 m<sup>2</sup>  
1.75 kW / dm<sup>3</sup> for the power module



(10 inputs and 8 outputs);

- 2 free slots for the installation of optional communication accessories such as network adaptors and extra volt free contacts;
- R.E.P.O. Remote Emergency Power Off.

The units are also compatible with:

- PowerShield<sup>3</sup> monitoring and shutdown software included for Windows operating systems 11, 10, 8, Server 2022, 2019, 2016 and previous versions, Windows Server Virtualization Hyper-V, macOS, Linux, Citrix XenServer and other Unix operating systems;
- RielloConnect for remote and proactive monitoring services.

### ULTRA SERVICEABILITY

The unit was carefully engineered to simplify positioning, installation and maintenance operations.

Connection terminals are accessible straight from the front of the unit for a safe and easy deployment.

All main elements are accessible from the front and, since they are hot-swappable, they can be replaced without any risk while the unit is still protecting the load, minimising the Mean Time to Repair (MTTR).

Thanks to the embedded intelligence, powerful computing capacity and outstanding connectivity, we can monitor

remotely the status of the UPS and provide dynamic and bespoke services to increase its lifespan.

## OVERVIEW

**Power cabinet  
MP2 500 PCM**

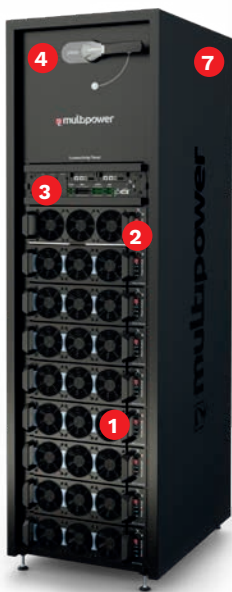

**Power cabinet  
M2S 1250 PCS**



1. 67 kW - 3U Power Modules.
2. Modular static bypass.
3. Connectivity Panel with:
  - In/Out signals (10 input, 8 output);
  - NetMan 208;
  - 2 extra communication slots;
  - R.E.P.O.
  - Parallel slots.

4. Manual bypass switch, standard for all MP2 500 PCM.
5. 6. I/O cabinets, complete with main input switch (5)\* and bypass, manual bypass and output switches (6)\*.
7. Cable entry:
  - MP2 500: Top (bottom optional);
  - M2S 1000/1250/1600: Top or bottom.

\*Available for PCS versions.

**MP2 500 PCM**  
with manual bypass  
up to 500 kW  
(front)

**M2S 1000-1250 PCO**  
without switches, up to 1000 or 1250 kW  
(front)

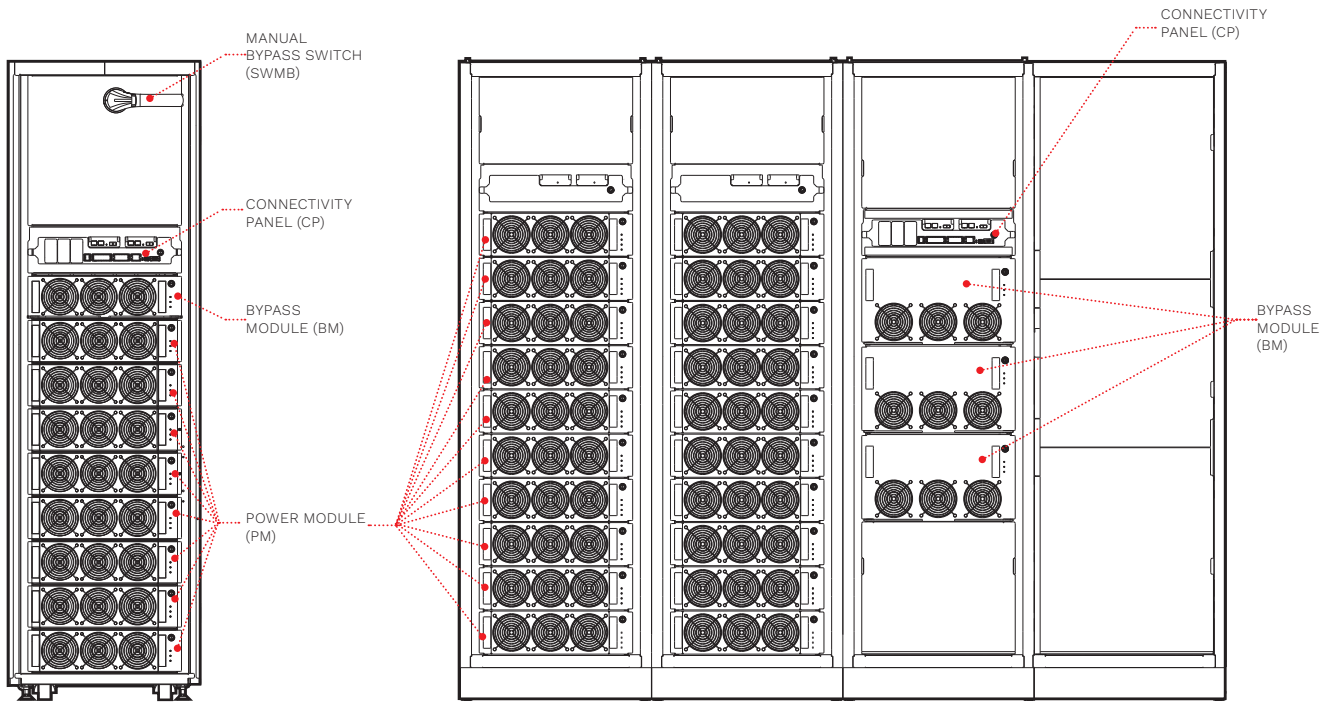

**M2S 1000-1250 PCS**  
with input, bypass, output and manual bypass switches  
up to 1000 or 1250 kW  
(front)

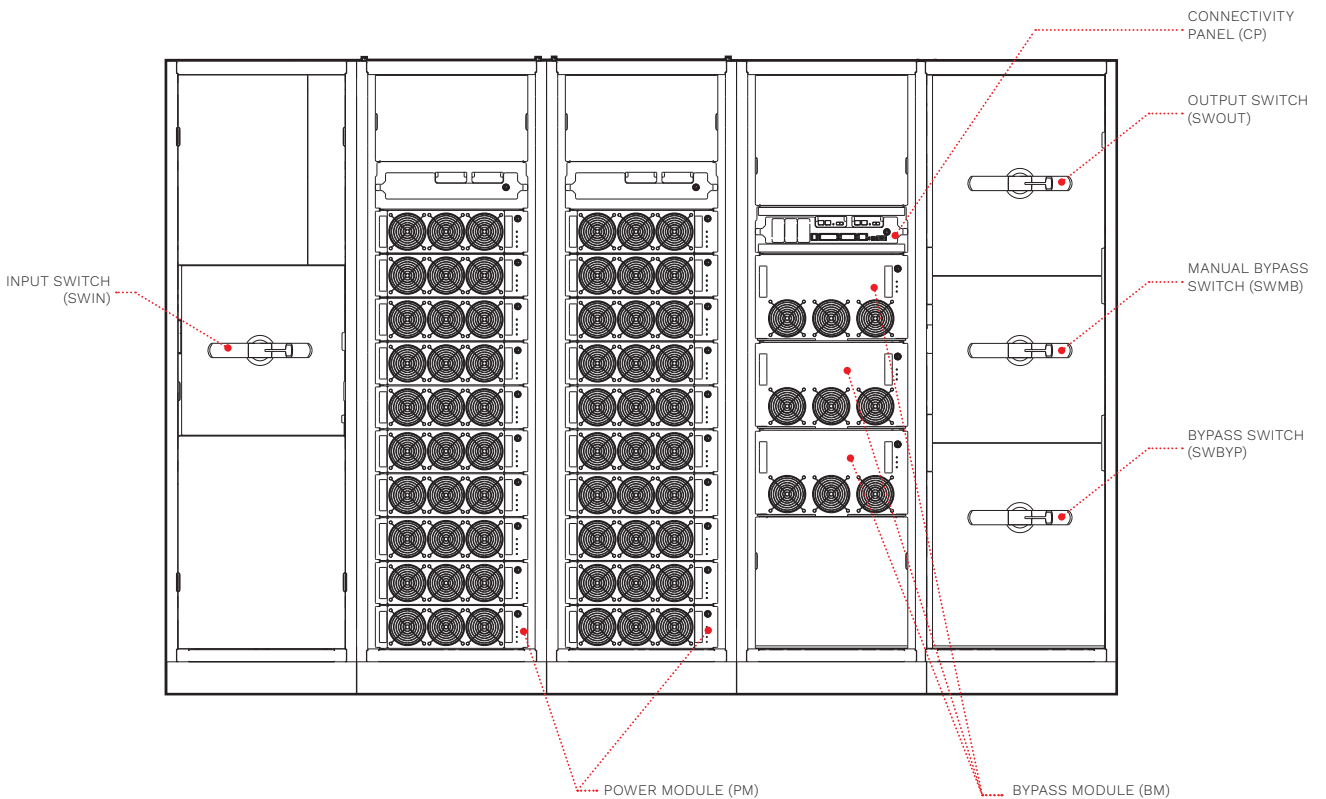

**M2S 1600 PCO**  
 without switches, up to 1600 kW  
 (front)

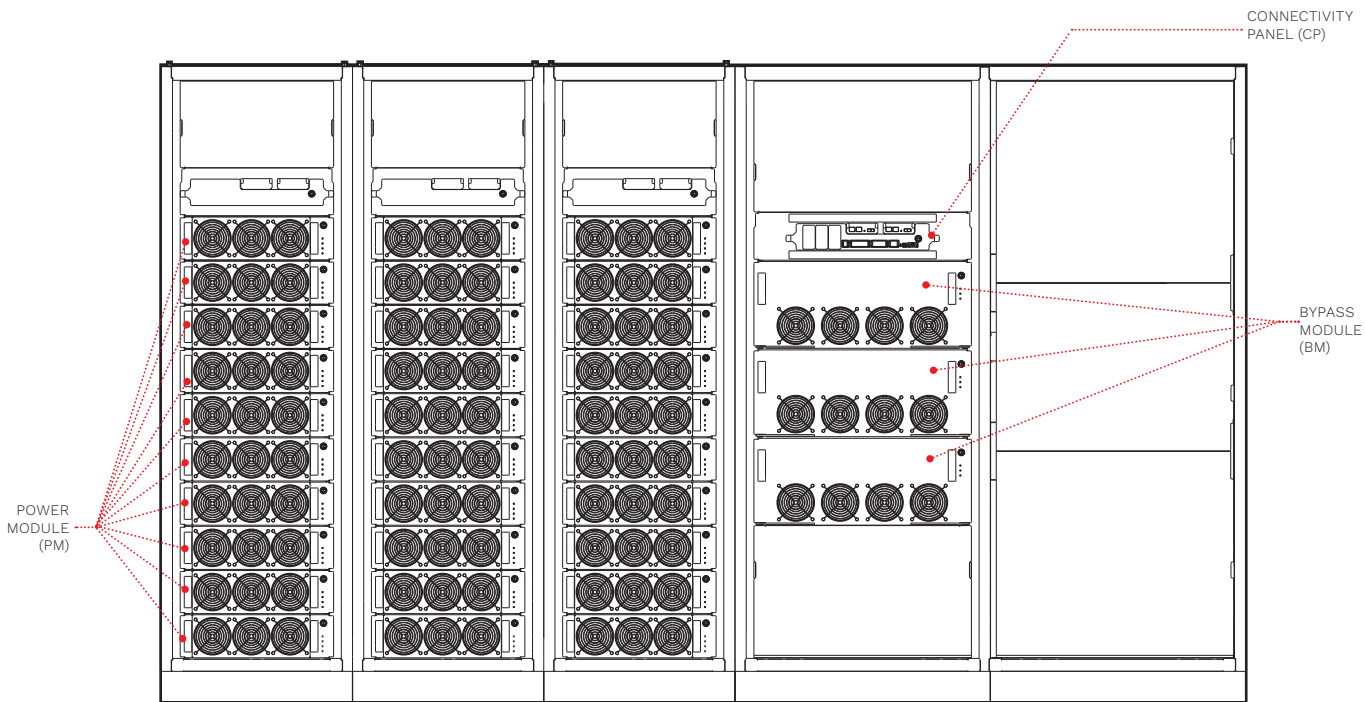

**M2S 1600 PCS**  
 with input, bypass, output and manual bypass switches  
 up to 1600 kW  
 (front)

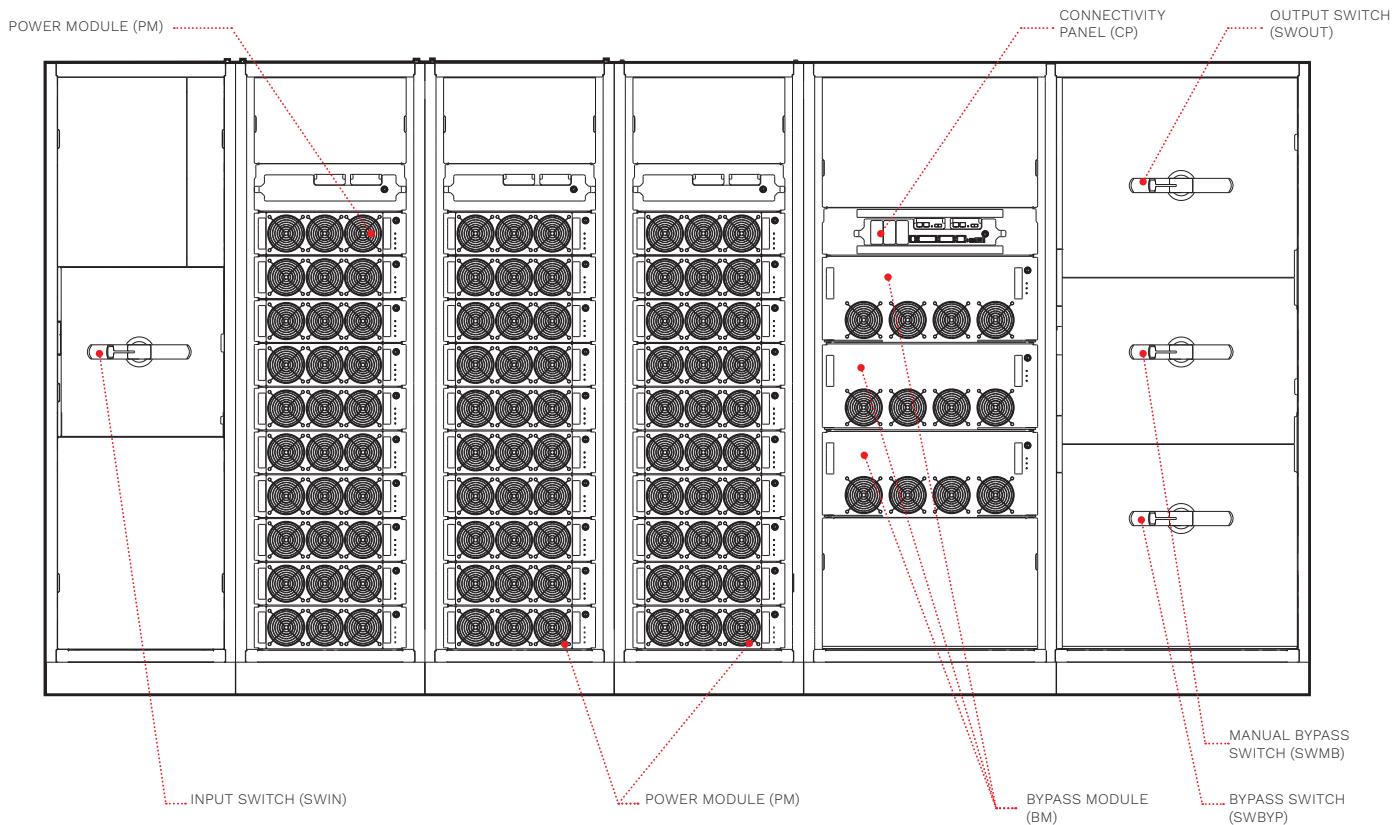

## DETAILS

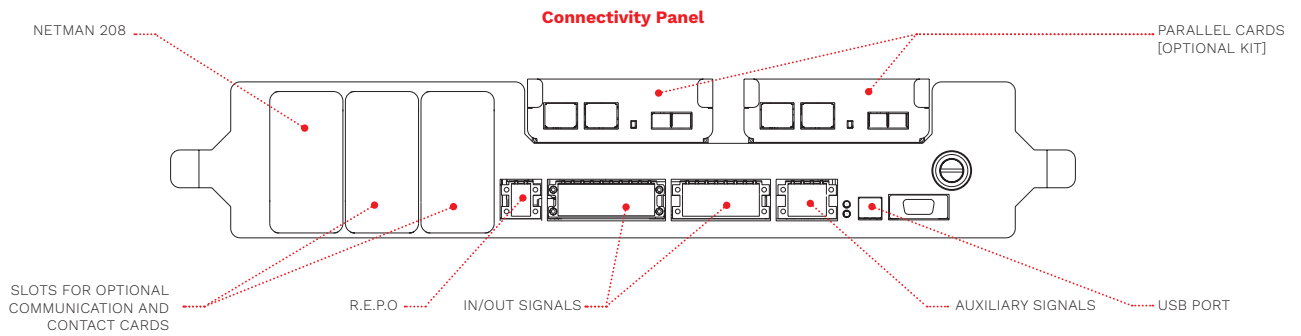

## BATTERY CABINETS

| MODELS          | MPW BATTERY CABINET / MPW 170 BTC<br>(MODULAR BATTERY CABINET) | BTC 2000 480V BB V8 3T<br>BTC 2000 480V BB V9 3T<br>BTC 2000 480V AB V9 3T<br>(CONVENTIONAL BATTERY CABINET) |
|-----------------|--|--|
| UPS MODELS      | Select the Battery configuration according to UPS rated power  |  |
| Dimensions [mm] | <p>Modular BC</p>  | <p>BTC</p>   |

## OPTIONS

| SOFTWARE                 | PRODUCT ACCESSORIES             |
|--------------------------|---------------------------------|
| PowerShield <sup>3</sup> | Parallel Kit                    |
| PowerNetGuard            | Battery temperature sensor      |
| <b>ACCESSORIES</b>       | IP31 Protection Kit             |
| NETMAN 208               | Programmable relay board        |
| MULTICOM 302             | MULTICOM 392                    |
| MULTICOM 352             | Connection cabinet (2x MP2 500) |
| MULTICOM 372             | Cold Start                      |
| MULTICOM 411             | Coating treatment               |
| MULTICOM 421             | Thermalscan                     |
| MULTI I/O                | ENERGYMANAGER                   |
| MULTIPANEL               |                                 |



| <b>MODEL</b>  | <b>Multi Power2 – from 500 to 1600 kW</b>   |                                   |                                   |                                   |
|---|---|-----------------------------------|-----------------------------------|-----------------------------------|
| <b>INPUT</b>  |   |                                   |                                   |                                   |
| Rated voltage [V]   | 380 / 400 / 415 three-phase + neutral   |                                   |                                   |                                   |
| Rated frequency [Hz]  | 50 / 60   |                                   |                                   |                                   |
| Voltage tolerance [V]                                       | 240 <sup>1</sup> - 480  |                                   |                                   |                                   |
| Frequency tolerance [Hz]                                    | 40 - 72   |                                   |                                   |                                   |
| Power factor  | 0.99  |                                   |                                   |                                   |
| THDI  | <3%   |                                   |                                   |                                   |
| <b>BYPASS</b>   |   |                                   |                                   |                                   |
| Nominal power [kW]  | 500 - 1000 - 1250 - 1600 (According to system power configuration)  |                                   |                                   |                                   |
| Rated voltage [V]   | 380 / 400 / 415 three-phase + neutral   |                                   |                                   |                                   |
| Voltage tolerance [V]                                       | from 180 (adjustable 180-200) to 264 (adjustable 250-264) referring to Neutral  |                                   |                                   |                                   |
| Rated frequency [Hz]  | 50 or 60  |                                   |                                   |                                   |
| Frequency tolerance   | ±5% (selectable)  |                                   |                                   |                                   |
| Overload  | 125% for 10 min; 150% for 1 min   |                                   |                                   |                                   |
| <b>BATTERIES</b>  |   |                                   |                                   |                                   |
| Battery arrangement (parallel systems)                      | Separate/common   |                                   |                                   |                                   |
| Type  | VRLA, NiCd, Li-Ion, Supercaps   |                                   |                                   |                                   |
| Recharging method   | One level, Two level, Cyclic recharge (selectable)  |                                   |                                   |                                   |
| <b>OUTPUT</b>   |   |                                   |                                   |                                   |
| Rated voltage [V]   | 380 <sup>2</sup> / 400 / 415 three-phase + neutral  |                                   |                                   |                                   |
| Rated frequency [Hz]  | 50 or 60  |                                   |                                   |                                   |
| Voltage stability   | ±1%   |                                   |                                   |                                   |
| Dynamic stability   | EN62040-3 class performance 1 non linear load   |                                   |                                   |                                   |
| <b>OVERALL SPECIFICATIONS</b>                               |   |                                   |                                   |                                   |
| Cabinet type  | <b>MP2 500<br/>Power Cabinet</b>  | <b>M2S 1000<br/>Power Cabinet</b> | <b>M2S 1250<br/>Power Cabinet</b> | <b>M2S 1600<br/>Power Cabinet</b> |
| UPS Nominal Power <sup>3</sup> [kW]                         | 500   | 1000                              | 1250                              | 1600                              |
| Bypass Power [kW]   | 500   | 1000                              | 1250                              | 1600                              |
| Power factor [pf]   | 1   |                                   |                                   |                                   |
| Module slots available                                      | 8   | 20                                | 20                                | 30                                |
| Number of PM to reach full power                            | 8x MP2 67 PM  | 15x MP2 67 PM                     | 19x MP2 67 PM                     | 24x MP2 67 PM                     |
| Parallelable up to  | 4 units   |                                   |                                   |                                   |
| Max power expandability [kW]                                | 2000  | 4000                              | 5000                              | 6400                              |
| Dimensions (WxDxH) [mm] & weight [kg] PCM <sup>4</sup> Type | 600x870x1995<br>640   | N.A.                              | N.A.                              | N.A.                              |
| Dimensions (WxDxH) [mm] & weight [kg] PC0 <sup>5</sup> Type | N.A.  | 2400x1025x2000<br>1866            | 2400x1025x2000<br>2014            | 3400x1025x2000<br>2465            |
| Dimensions (WxDxH) [mm] & weight [kg] PCS <sup>6</sup> Type | N.A.  | 3000x1025x2000<br>2216            | 3000x1025x2000<br>2364            | 4000x1025x2000<br>2815            |
| System Noise Level [dBA±2]                                  | <69   | <75                               |                                   |                                   |
| ECO Mode Efficiency   | up to 99%   |                                   |                                   |                                   |
| Cabinet IP rating   | IP20 (IP31 as optional)   |                                   |                                   |                                   |
| Cable Input   | Front access - top<br>(bottom with optional)  | Front access - top or bottom      |                                   |                                   |
| Colour  | RAL 9005  |                                   |                                   |                                   |
| Ambient temp. for the UPS                                   | 0 °C - +40 °C   |                                   |                                   |                                   |
| Ventilation   | Front to rear   |                                   |                                   |                                   |
| Range of relative humidity                                  | 5-95% non-condensing  |                                   |                                   |                                   |
| Standards   | European directives: LV 2014/35/EU low voltage Directive EMC 2014/30/EU electromagnetic compatibility<br>Directive Standards: Safety IEC EN 62040-1; EMC IEC EN 62040-2; RoHS compliant<br>Classification in accordance with IEC 62040-3 (Voltage Frequency Independent) VFI - SS - 111 |                                   |                                   |                                   |
| Moving UPS cabinet types                                    | Castors (cabinets shipped without PM)   |                                   | Pallet jack                       |                                   |

<sup>1</sup> Conditions apply.

<sup>2</sup> For wider tolerance conditions apply.

<sup>3</sup> Power rating between 500 kW and 1600 kW can be settled with a selected number of Power Modules.

<sup>4</sup> With Manual Bypass switch only, weight including Power Modules to reach full power.

<sup>5</sup> Without Input, Bypass, Output, Manual Bypass Switches, weight including Power Modules to reach full power.

<sup>6</sup> With Input, Bypass, Output, Manual Bypass switches, weight including Power Modules to reach full power.

# Sentryum Rack



E-MEDICAL



EMERGENCY



INDUSTRY



TRANSPORT



ONLINE



Modular



Service  
1st start



SmartGrid  
ready



USB  
plug

**1-3:1** 20-160 kVA/kW  
**1-3:3** 20-160 kVA/kW



## HIGHLIGHTS

- **High adaptability to input voltage**
- **Compatible with industrial environments**
- **Modular Plug & Play solution**
- **Suitable for stand alone and modular installations**
- **Complete flexibility**
- **Graphic touch screen display**

The Sentryum Rack range was specially developed to ensure power continuity in all sectors deemed critical due to the specific environmental conditions or industrial processes requiring protection. It is a true ON LINE double conversion UPS available in a 20 kVA/kW standalone version and in modular versions from 20 to 160 kVA/kW. The Sentryum Rack is available in both single-phase and three-phase output configurations. It accepts both single-phase and three-phase inputs with no need for special setups or operator intervention. The voltage arrangement could change during operation without any reset or manual operation, therefore the UPS auto detects the input voltage and behaves accordingly.

## COMPATIBLE WITH INDUSTRIAL ENVIRONMENTS

The basic building block is a 20 kVA/kW module. Its connection clamps are laid out so that the communication signal connections are segregated and separated from the power connections (inputs, output, battery), thus ensuring complete immunity from interference generated by the power supply grid, which is typically disturbed in industrial environments. The module has a front to back air flow realised by a smart ventilation principle, which manages the fan speed and airflow in accordance with the current room temperature and load level. The Sentryum Rack cabinet is available in 2 versions, single-phase and three-phase output; it is designed to house up to 3 modules (60 kVA/kW) and it can be



connected in parallel for a total of 8 modules and 160 kVA/kW of power. The Sentryum Rack cabinet has a distribution panel that contains all the devices to disconnect each module (3 input rectifier disconnectors, 3 input bypass disconnectors, 3 output disconnectors, 3 battery fuse holders), as well as a manual maintenance bypass that isolates the 3 modules and guarantees power continuity to the load. Both modules and cabinets are provided with the bypass line separated from the rectifier line, ensuring greater availability of the power supply to the UPS system and consequently extending this benefit to the load.

#### MODULAR PLUG & PLAY SOLUTION

Sentryum Rack can be purchased as a single 20 kVA/kW module and installed in a 19-inch rack cabinet or mechanical support provided by the user. Another way is to lean the module on the right side; the display can be rotated 90° counter clockwise. It is also possible to remote the display (maximum 2 meters) in case the module is fitted inside a cabinet. The power terminals (inputs, output, battery) are connected by front hating connectors, ensuring simplicity and operating safety during insertion/removal, protection against electrical contacts and immunity from environmental conditions typical of industrial settings (dust, humidity, suspended chemical particles). The removal and replacement of a faulty module or the addition into the system of a new one can be carried out easily by the user from the front panel.

#### FLEXIBILITY: STAND ALONE AND RACK CABINET

The Sentryum Rack module can be used as a standalone unit or in a parallel configuration; by simply adding the parallel kit for each module, the UPS system can grow as requirements demand (from 20 to 160 kVA/kW). Every module is completely independent with regards to the control and management of the operator interfaces; this facilitates all monitoring, control and fault detection operations, ensuring increased reliability in that any malfunctions in parts or accessories will not propagate through the entire system. Sentryum Rack ensures vertical scalability that minimises the system footprint, the user can thus have power capabilities from 20 to 60 kVA/kW for a single Sentryum Rack cabinet without increasing the footprint.

The 20 kVA/kW module in the standalone version is provided with input/output plug-in hating power connectors (inputs, output, battery) with three meter length loose electrical cable to arrange the cabling according with the installation enclosure. These cables are not provided when the

module is ordered to be fitted inside the Sentryum Rack cabinet, because they are already installed inside as standard. Standalone module versions can be housed in any suitable cabinet or enclosure as it is compatible with standard 19" width.

#### HIGH EFFICIENCY, POWER AVAILABILITY AND RELIABILITY

This Series is derived from the Sentryum series and essentially inherits its main technologies and standalone module versions:

- Full power rating available up to 40 °C (kVA=kW unity pf) and up to 96.3% VFI efficiency;
- Zero impact source, thanks to a very low input THDi <3%, input pf 0.99, power walk-in function, power walk-in start delay function;
- Up to 20 Amps battery recharging current and wide battery block range (the standard 20+20 battery blocks @ 12V with Neutral central point can be adjusted from 15+15 to 22+22);
- Three-level IGBT inverter, extremely low output THDv;
- Up to 270% inverter current for 200 msec. and 150% for 300 msec., which enables the system to deal with sudden peak loads (without static bypass intervention) and provide the short circuit current if required during operation on battery;
- "Cold start" function for starting the UPS from the battery.

In addition, Sentryum Rack provides a filtering and power factor correction function within the power network upstream of the UPS, thus eliminating harmonic components and reactive power generated by the power utilities.

#### SMART BATTERY MANAGEMENT

The Smart Battery Management system, which is also compatible with Li-Ion batteries and Supercapacitors, consists of a series of features and capabilities to optimise battery management and obtain the best possible performance and operating life:

- Battery recharging for use with VRLA, AGM, GEL, Open Vented and Nickel Cadmium batteries;
- Availability of different charging methods, like one-level voltage recharge (typically used for VRLA AGM batteries), two-level voltage recharge (according to IU specification) and cyclical recharge (to reduce electrolyte consumption and lengthen the life of VRLA batteries);
- Recharge voltage compensation based on ambient temperature;
- Battery tests to diagnose in advance any



Sentryum Rack Cabinet (Single-phase model).

reduction in performance or problems with the batteries;

- Deep discharge protection, by increasing the end-of-discharge voltage during extended low-load discharges, as recommended by battery manufacturers;
- Negligible Ripple current (residual AC component at low frequency) by using a high frequency battery charger;
- Wide voltage range for the rectifier operating (up to -40% at half load).

#### ADVANCED COMMUNICATIONS

Sentryum Rack module is equipped with a coloured graphic touch screen display providing UPS information, measurements, operating statuses and alarms in different languages. The default screen displays the UPS status, graphical indication of the energy path through the UPS and the operational condition of the various assemblies (rectifier, batteries, inverter, bypass) within the UPS. Furthermore, the user interface includes a UPS status led bar which delivers immediate and clear information regarding the overall status of the UPS by changing the colour (light blue, dark blue, orange and red) according with the operating mode and condition.

- Advanced multi-platform communications

for all operating systems and network environments: PowerShield<sup>3</sup> monitoring and shutdown software included for Windows operating systems 11, 10, 8, Hyper-V, Server 2022, 2019, 2016 and previous versions, Windows Server Virtualization Hyper-V, macOS, Linux, Citrix XenServer and other Unix operating systems;

- Compatible with VMware infrastructures to perform graceful shutdown of hosts and clusters; to perform Vmotion and prioritised shutdown of VM thanks to NetMan 208 Network card;
- Compatible with Nutanix and Syneto infrastructures to perform graceful shutdown of hosts; to perform prioritised shutdown of VM thanks to NetMan 208 Network card;
- Compatible with RielloConnect (remote monitoring service);
- RS232 port on RJ10 connector and USB ports;
- 2 slots for optional communications cards such as network adaptors and volt free contacts etc;
- Embedded contact interface which includes 5 programmable inputs and 4 programmable outputs;
- R.E.P.O. Remote Emergency Power Off for switching off the UPS via a remote emergency button;
- Graphic display panel for remote connection.



Sentryum Rack Module (Stand alone solution fitted inside a 19" rack cabinet) – Compatible for installation in any 19" enclosure.

## OPTIONS

### SOFTWARE

PowerShield<sup>3</sup>  
PowerNetGuard

### ACCESSORIES

NETMAN 208  
MULTICOM 302  
MULTICOM 352  
MULTICOM 384  
MULTICOM 411

MULTICOM 421  
MULTI I/O  
MULTIPANEL

### PRODUCT ACCESSORIES

Parallel Kit  
Battery temperature sensor  
MULTICOM 392  
ENERGYMANAGER

## DETAILS

### Sentryum Rack (UPS MODULE - front)

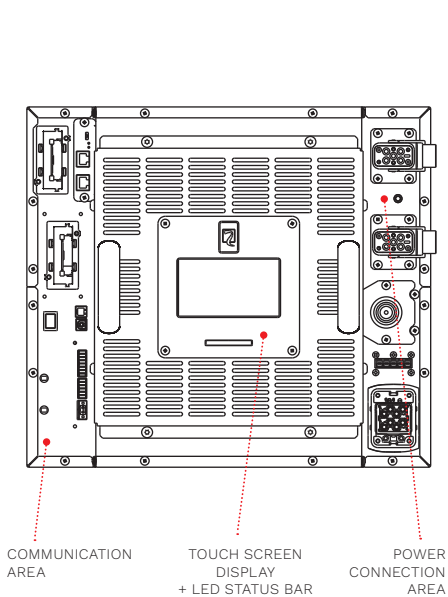

### Communication Area

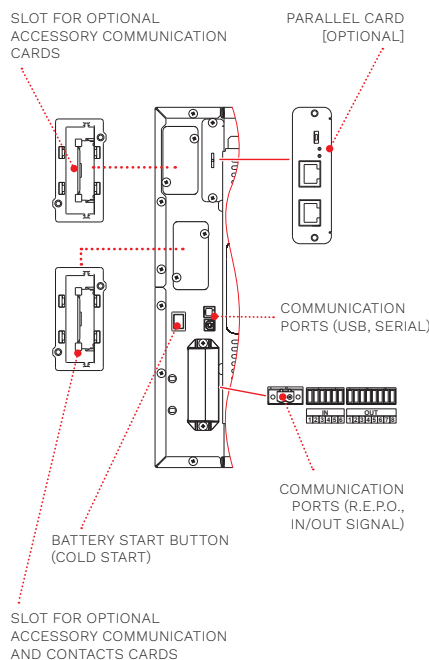

### Power Connection Area

Single-phase version      Three phase version

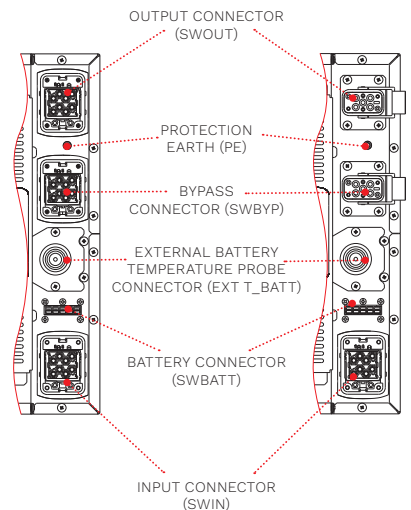

| <b>MODELS</b>                               | <b>Single-phase output (SRM)<br/>from 20 kVA/kW to 160 kVA/kW</b>  | <b>Three-phase output (SRT)<br/>from 20 kVA/kW to 160 kVA/kW</b> |
|---|--|--|
| <b>INPUT</b>                                |  |  |
| Rated voltage [V]                           | 220 / 230 / 240 single-phase + N and 380 / 400 / 415 three-phase + N   |  |
| Rated frequency [Hz]                        | 50 / 60  |  |
| Voltage tolerance [V]                       | 230 / 400 ±20% @ full load <sup>1</sup>  |  |
| Frequency tolerance [Hz]                    | 40 - 72  |  |
| Power factor @ full load                    | 0.99   |  |
| Current distortion                          | THDI ≤3%   |  |
| <b>BYPASS</b>                               |  |  |
| Rated voltage [V]                           | 220 / 230 / 240 single-phase + N   | 380 / 400 / 415 three-phase + N                                  |
| Number of phases                            | 1 + N  | 3 + N  |
| Voltage tolerance (ph-N) [V]                | from 180 (adjustable 180-200) to 264 (adjustable 250-264) referring to neutral   |  |
| Rated frequency [Hz]                        | 50 or 60 (selectable)  |  |
| Frequency tolerance                         | ±5% (selectable)   |  |
| Bypass overload                             | 110% infinite, 125% for 60 min, 150% for 10 min  |  |
| <b>OUTPUT</b>                               |  |  |
| Nominal power [kVA]                         | 20   |  |
| Active power [kW]                           | 20   |  |
| Power factor                                | 1 up to 40 °C  |  |
| Number of phases                            | 1 + N  | 3 + N  |
| Rated voltage [V]                           | 220 <sup>1</sup> / 230 / 240 single-phase + N (selectable)   | 380 <sup>1</sup> / 400 / 415 three-phase + N (selectable)        |
| Rated frequency [Hz]                        | 50 or 60   |  |
| Frequency stability on battery operation    | 0.01%  |  |
| Voltage stability                           | ±1%  |  |
| Dynamic stability                           | EN 62040-3 class performance 1 non-linear load   |  |
| Voltage distortion                          | <1% with resistive linear load / ≤1.5% with non-linear load  |  |
| <b>BATTERIES</b>                            |  |  |
| Type  | VRLA AGM/GEL/NiCd/Li-ion/SuperCaps   |  |
| Recharging method                           | One level, Two level, Cyclic recharge (selectable)   |  |
| <b>OVERALL SPECIFICATIONS</b>               |  |  |
| Weight of the Power Module [kg]             | 41   |  |
| Dimensions of the Power Module (WxDxH) [mm] | 445(19")x664x397(9U)   |  |
| Weight of the cabinet [kg]                  | 165 (Power Modules excluded)   |  |
| Dimensions of the cabinet (WxDxH) [mm]      | 700x750x2060 (if provided by Riello UPS)   |  |
| Maximum number of Power Modules for cabinet | 3  |  |
| Communications for each Power Module        | UPS status led bar - 5 inch graphic touch screen display - 2 slots for communications interface<br>USB - RS232 - Contact interface with 5x opto insulated Input and 4x Output relays   |  |
| Ambient temperature for the Power Module    | 0 °C - +40 °C  |  |
| Recommended temperature for battery life    | +20 °C - +25 °C  |  |
| Range of relative humidity                  | 5-95% non-condensing   |  |
| Colour                                      | RAL 9005   |  |
| Noise level at 1 m [dBA ±2]                 | <40 for the single power module  |  |
| SMART ACTIVE                                |  |  |
| IP rating                                   | IP20   |  |
| SMART ACTIVE efficiency                     | up to 99%  |  |
| Standards                                   | European directives: LV 2014/35/EU low voltage Directive EMC 2014/30/EU electromagnetic compatibility<br>Directive Standards: Safety IEC EN 62040-1; EMC IEC EN 62040-2; RoHS compliant<br>Classification in accordance with IEC EN 62040-3 (Voltage Frequency Independent) VFI - SS - 111 |  |
| Moving the parts                            | Pallet jack (UPS cabinet) - 2 operators (UPS Power Module)   |  |

<sup>1</sup> For wider tolerance conditions apply.

# Sentryum Rack Marine



ONLINE



Modular



Service  
1st start



SmartGrid  
ready



USB  
plug



**1-3:1** 20-160 kVA/kW  
**1-3:3** 20-160 kVA/kW

## HIGHLIGHTS

- **High adaptability to input voltage**
- **Compatible with marine environments**
- **High performance high yield strength steel cabinet**
- **No clearance required around the cabinet**
- **Modular Plug & Play solution**
- **Suitable for stand alone and modular installations**
- **Complete flexibility**
- **Graphic touch screen display on both the module and cabinet front door**

The Sentryum Rack Marine range was specially developed to ensure power continuity in all sectors deemed critical due to the specific environmental conditions or marine processes requiring protection.

It is a true ON LINE double conversion UPS, available in a 20 kVA/kW standalone version and in modular versions from 20 to 160 kVA/kW. The Sentryum Rack Marine is available in both single-phase and three-phase output configurations. It accepts both single-phase and three-phase inputs with no need for special setup or operator intervention. The voltage arrangement could change during operation without any reset or manual operation, therefore the UPS auto detects the input voltage and behaves accordingly.

## COMPATIBLE WITH MARINE ENVIRONMENTS

The basic building block is a 20 kVA/kW module. Its connection clamps are laid out so that the communication signal connections are segregated and separated from the power connections (inputs, output, battery), thus ensuring complete immunity from interference generated by the power supply grid, which is typically disturbed in marine environments. The module has a front to back air flow realised by a smart ventilation principle, which manages the fan speed and airflow in accordance with the room temperature and load level. The PCBs in each module undergo a coating treatment process. As all components are fully accessible

from the front of each module and thanks to the front-to-front air ventilation system, the Sentryum Rack Marine cabinet can be installed right against the wall or back to back. The construction characteristics of the cabinet (fiber laser welded box-type uprights manufactured from high-strength low-alloy sheet steel), including its basement complete with vibration dampers, make the Sentryum Rack Marine suitable for installation in the most severe environments.

The Sentryum Rack Marine cabinet is available in 2 versions, single-phase and three-phase output; it is designed to house up to 3 modules (60 kVA/kW) and it can be connected in parallel for a total of 8 modules and 160 kVA/kW of power. The Sentryum Rack Marine cabinet has a distribution panel that contains all the devices to disconnect each module (3 input rectifier disconnectors, 3 input bypass disconnectors, 3 output disconnectors, 3 battery fuse holders), as well as a manual maintenance bypass that isolates the 3 modules and guarantees power continuity to the load. Both modules and cabinets are provided with the bypass line separated from the rectifier line, ensuring greater availability of the power supply to the UPS system and consequently extending this benefit to the load. Input and Output voltage adapter cabinets are available on request, in order to match all the typical ship requirements and provide the galvanic isolation.

#### **MODULAR PLUG & PLAY SOLUTION**

Sentryum Rack Marine can be purchased as a single 20 kVA/kW module and installed in a 19-inch rack cabinet or mechanical support provided by the user. Another way is to lean the module on the right side; the display can be rotated 90° counter clockwise. It is also possible to remote the display (maximum 2 meters) in case the module is fitted inside a cabinet. The power terminals (inputs, output, battery) are connected by front harting connectors, ensuring simplicity and operating safety during insertion/removal, protection against electrical contacts and immunity from environmental conditions typical of marine settings (dust, humidity, brackish atmosphere, suspended chemical particles). The removal and replacement of a faulty module or the addition into the system of a new one can be carried out easily by the user from the front panel.

#### **FLEXIBILITY: STAND ALONE AND RACK CABINET**

The Sentryum Rack Marine module can be used as a standalone unit or in a parallel configuration; by simply adding the parallel kit for each module, the UPS system can grow as requirements demand (from 20 to 160 kVA/kW). Every module is completely independent with regards to the control and management of the operator interfaces; this facilitates all monitoring, control and fault detection operations, ensuring increased reliability in that any malfunctions in parts or accessories will not propagate through the entire system. Sentryum Rack Marine offers vertical scalability that minimises the system footprint; the user can have power capabilities from 20 to 60 kVA/kW in a single Sentryum Rack Marine cabinet without increasing the footprint. The 20 kVA/kW module in the standalone version is provided with input/output plug-in harting power connectors (inputs, output, battery) with three meter length loose electrical cable to arrange the cabling according with the installation enclosure. These cables are not provided when the module is ordered to be fitted inside the Sentryum Rack Marine cabinet, because they are already installed inside it as standard. Standalone module versions can be housed in any suitable cabinet or enclosure as it is compatible with standard 19" width.

#### **HIGH EFFICIENCY, POWER AVAILABILITY AND RELIABILITY**

This Series is derived from the Sentryum and essentially inherits its main technologies and standalone module versions:

- Full power rating available up to 45 °C (kVA=kW unity pf) and up to 96.3% VFI efficiency;
- Zero impact source, thanks to a very low input THDi <3%, input pf 0.99, power walk-in function, power walk-in start delay function;
- Up to 20 Amps battery recharging current and wide battery block range (the standard 20+20 battery blocks @ 12V with Neutral central point can be adjusted from 15+15 to 22+22);
- Three-level IGBT inverter, extremely low output THDv;
- Up to 270% inverter current for 200 msec. and 150% for 300 msec., which enables the system to deal with sudden peak loads (without static bypass intervention) and provide the short circuit current if required during operation on battery;
- "Cold start" function for starting the UPS from the battery.

In addition, Sentryum Rack Marine provides a filtering and power factor correction function within the power network upstream of the UPS, thus eliminating harmonic components and reactive power generated by the power utilities.

#### **SMART BATTERY MANAGEMENT**

The Smart Battery Management system, which is also compatible with Li-Ion batteries and Supercapacitors, consists of a series of features and capabilities to optimise battery management and obtain the best possible performance and operating life:

- Battery recharging for use with VRLA, AGM, GEL, Open Vented and Nickel Cadmium batteries;
- Availability of different charging methods, like one-level voltage recharge (typically used for VRLA AGM batteries), two-level voltage recharge (according to IU specification) and Cyclical recharge (to reduce electrolyte consumption and lengthen the life of VRLA batteries);
- Recharge voltage compensation based on ambient temperature;
- Battery tests to diagnose in advance any reduction in performance or problems with the batteries;
- Deep discharge protection, by increasing the end-of-discharge voltage during extended low-load discharges, as recommended by battery manufacturers;
- Negligible Ripple current (residual AC component at low frequency) by using a high frequency battery charger;
- Wide voltage range for the rectifier operating (up to -40% at half load).

#### **ADVANCED COMMUNICATIONS**

Sentryum Rack Marine module is equipped with a coloured graphic touch screen display providing UPS information, measurements, operating statuses and alarms in different languages. The default screen displays the UPS status, graphical indication of the energy path through the UPS and the operational condition of the various assemblies (rectifier, batteries, inverter, bypass) within the UPS. Furthermore, the user interface includes a UPS status led bar which delivers immediate and clear information regarding the overall status of the UPS by changing the colour (light blue, dark blue, orange and red) according with the operating mode and condition. Thanks to the 10" touchscreen colour display (capacitive) placed on the front door of the Sentryum Rack Marine cabinet, it is possible to monitor the whole UPS System and the status of each power module fitted inside the cabinet.

- Advanced multi-platform communications for all operating systems and network environments: PowerShield3 monitoring and shutdown software included for Windows operating systems 11, 10, 8, Hyper-V, Server 2022, 2019, 2016 and previous versions, Windows Server Virtualization Hyper-V, macOS, Linux, Citrix XenServer and other Unix operating systems;
- Compatible with VMware infrastructures to perform graceful shutdown of hosts and clusters; to perform Vmotion and prioritised shutdown of VM thanks to

- NetMan 208 Network card;
- Compatible with Nutanix and Syneto infrastructures to perform graceful shutdown of hosts; to perform prioritised shutdown of VM thanks to NetMan 208 Network card;
- Compatible with RielloConnect (remote monitoring service);
- RS232 port on RJ10 connector and USB ports;
- 2 slots for optional communications cards such as network adaptors and volt free contacts etc;
- Embedded contact interface which

- includes 5 programmable inputs and 4 programmable outputs;
- R.E.P.O. Remote Emergency Power Off for switching off the UPS via a remote emergency button;
- Graphic display panel for remote connection.



Sentryum Rack Marine Module (Stand alone solution fitted inside a 19" rack cabinet) – Compatible for installation in any 19" enclosure.

## OPTIONS

### SOFTWARE

PowerShield<sup>3</sup>  
PowerNetGuard

### ACCESSORIES

NETMAN 208  
MULTICOM 302  
MULTICOM 352  
MULTICOM 384  
MULTICOM 411  
MULTICOM 421  
MULTI I/O  
MULTIPANEL

### PRODUCT ACCESSORIES

Parallel Kit  
Battery temperature sensor  
MULTICOM 392  
ENERGYMANAGER

## DETAILS

### Sentryum Rack Marine (UPS MODULE - front)

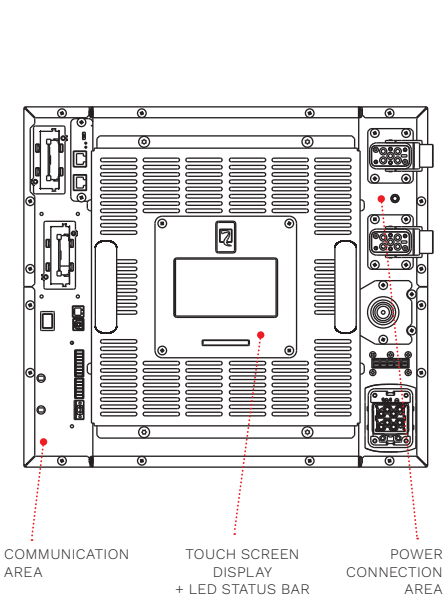

### Communication Area

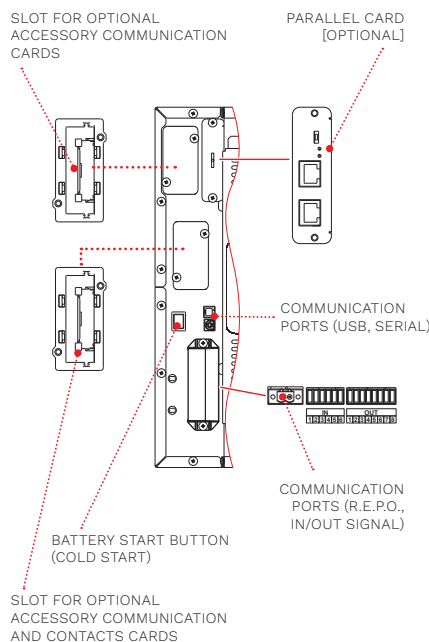

### Power Connection Area

Single-phase version      Three phase version

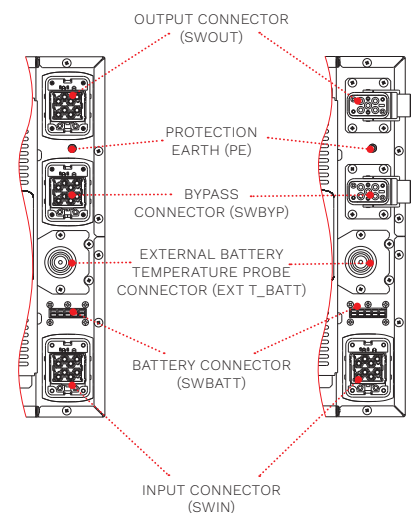



| <b>MODELS</b>                                | <b>Single-phase output (SMM)<br/>from 20 kVA/kW to 160 kVA/kW</b>   | <b>Three-phase output (SMT)<br/>from 20 kVA/kW to 160 kVA/kW</b> |
|--|---|--|
| <b>INPUT</b>                                 |   |  |
| Rated voltage [V]                            | 220 / 230 / 240 single-phase + N and 380 / 400 / 415 three-phase + N  |  |
| Rated frequency [Hz]                         | 50 / 60   |  |
| Voltage tolerance [V]                        | 230 / 400 ±10% @ full load <sup>1</sup>   |  |
| Frequency tolerance [Hz]                     | 40 - 72   |  |
| Power factor @ full load                     | 0.99  |  |
| Current distortion                           | THDI ≤3%  |  |
| <b>BYPASS</b>                                |   |  |
| Rated voltage [V]                            | 220 / 230 / 240 single-phase + N  | 380 / 400 / 415 three-phase + N                                  |
| Number of phases                             | 1 + N   | 3 + N  |
| Voltage tolerance (ph-N) [V]                 | from 180 (adjustable 180-200) to 264 (adjustable 250-264) referring to neutral  |  |
| Rated frequency [Hz]                         | 50 or 60 (selectable)   |  |
| Frequency tolerance                          | ±5% (selectable)  |  |
| Bypass overload                              | 110% infinite, 125% for 60 min, 150% for 10 min   |  |
| <b>OUTPUT</b>                                |   |  |
| Nominal power [kVA]                          | 20  |  |
| Active power [kW]                            | 20  |  |
| Power factor                                 | 1 up to 45 °C   |  |
| Number of phases                             | 1 + N   | 3 + N  |
| Rated voltage [V]                            | 220 <sup>1</sup> / 230 / 240 single-phase + N (selectable)  | 380 <sup>1</sup> / 400 / 415 three-phase + N (selectable)        |
| Rated frequency [Hz]                         | 50 or 60  |  |
| Frequency stability on battery operation     | 0.01%   |  |
| Voltage stability                            | ±1%   |  |
| Dynamic stability                            | EN 62040-3 class performance 1 non-linear load  |  |
| Voltage distortion                           | <1% with resistive linear load / ≤1.5% with non-linear load   |  |
| <b>BATTERIES</b>                             |   |  |
| Type   | VRLA AGM/GEL/NiCd/Li-ion/SuperCaps  |  |
| Recharging method                            | One level, Two level, Cyclic recharge (selectable)  |  |
| <b>OVERALL SPECIFICATIONS</b>                |   |  |
| Weight of the Power Module [kg]              | 41  |  |
| Dimensions of the Power Module (WxDxH) [mm]  | 445(19")x664x397(9U)  |  |
| Weight of the cabinet [kg]                   | 165 (Power Modules excluded) <sup>3</sup>   |  |
| Dimensions of the Power Cabinet (WxDxH) [mm] | 615x830x2100 (if provided by Riello UPS) <sup>3</sup>   |  |
| Maximum number of Power Modules for cabinet  | 3   |  |
| Communications for each Power Module         | UPS status led bar - 5 inch graphic touch screen display - 2 slots for communications interface<br>USB - RS232 - Contact interface with 5x opto insulated Input and 4x Output relays  |  |
| Ambient temperature for the Power Module     | 0 °C - +45 °C   |  |
| Recommended temperature for battery life     | +20 °C - +25 °C   |  |
| Range of relative humidity                   | 5-95% non-condensing  |  |
| Colour                                       | Module RAL 7035 <sup>4</sup>  |  |
| Noise level at 1 m [dBA ±2] SMART ACTIVE     | <40 for the single power module   |  |
| IP rating                                    | IP20  |  |
| SMART ACTIVE efficiency                      | up to 99%   |  |
| Standards                                    | European directives: LV 2014/35/EU low voltage Directive EMC 2014/30/EU electromagnetic compatibility<br>Directive Standards: Safety IEC EN 62040-1; EMC IEC EN 62040-2; RoHS compliant<br>Classification in accordance with IEC EN 62040-3 (Voltage Frequency Independent) VFI - SS - 111 <sup>2</sup> |  |
| Moving the parts                             | Pallet jack (UPS cabinet) - 2 operators (UPS Power Module)  |  |

<sup>1</sup> For wider tolerance conditions apply.

<sup>2</sup> Marine Type Approval (in progress).

<sup>3</sup> The overall dimensions of the complete UPS system depend on the required configuration.

<sup>4</sup> The external colour of the Cabinet can be customised according to the customer's needs using the RAL colour matching system.

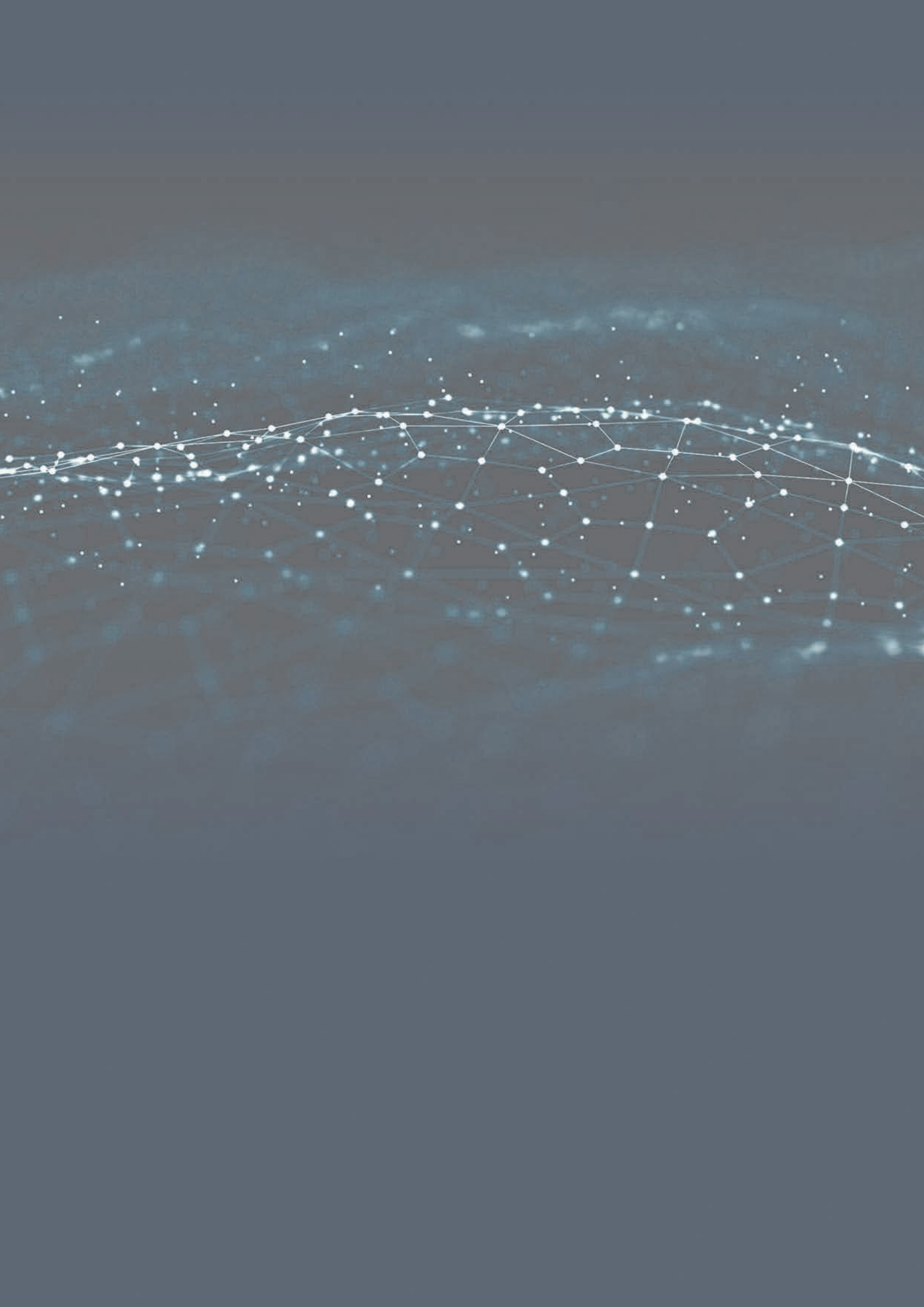

**UPS for  
North America  
(UL/CSA standards)**



**INTRODUCTION**

With over 35 years' experience in the power conversion industry, the Riello Elettronica Group delivers, through its main brand Riello UPS, innovative energy-efficient, scalable and cost-effective power solutions to guarantee quality energy for applications including Data Centers, Electromedical and Healthcare, Emergency Lighting, Industrial Facilities, Telecommunication and Offices (Digital Living). Through the presence of a direct subsidiary in the United States, RPS America Inc. located in Ohio, Riello Elettronica Group offers an extensive range

of UPS compliant with all standard North America regulations (UL/CSA). Riello UPS America is constantly committed to providing high quality products and services to ensure that the customers get the best performance from their UPS, ensuring high availability and maximizing total cost of ownership. Production quality is an integral part of Riello UPS America's corporate philosophy. It begins with the customer's order and continues throughout the production chain, right up to delivery.

During the entire process the level of attention to quality is fundamental: in addition, each UPS is individually tested before leaving the factory with a 100% electrical test. Factory acceptance tests (FATs) are also a fundamental service for Riello UPS America. The pursuit of quality, the optimization of resources and a strong drive towards technological innovation, together with seriousness, consistency and experience, make RPS America Inc. a company able to meet the needs of a fast-growing market.

For further details about the North American Riello UPS portfolio, please visit [www.rielloupsamerica.com](http://www.rielloupsamerica.com)

## Sentinel Pro











- **Power factor 0.9**
- **Operating flexibility**
- **Emergency function**
- **Battery optimisation**
- **Runtime expandability**
- **Low noise level**

Sentinel Pro has a unique, modern design and improved performance created by the Riello UPS research and development team. Sentinel Pro uses ON LINE double conversion technology, resulting in the highest levels of reliability and maximum protection for critical loads such as servers and IT and voice/data applications. For business continuity applications requiring long battery runtimes, battery autonomy can be extended up to several hours using ER models fitted with more powerful battery chargers. The front display panel has been entirely redesigned, adding an LCD display that shows the input and

**True-ON LINE UPS System**

**1:1** 700-3000 VA  
 Input 208-240 V 60 Hz  
 output 220/240 V 60 Hz

|  |  |   |   |
|--|--|---|---|
| <br>DIGITAL LIVING | <br>E-MEDICAL | <br>EMERGENCY                            | <br>INDUSTRY                 |
| <br>ONLINE         | <br>Tower     | <br>GS Nemko certified                   | <br>Plug & Play installation |
| <br>Supercaps UPS | <br>USB plug  | <br>TUV Rheinland of North America, Inc. |   |

output voltages, battery readings and UPS operating status information. The inverter and the microprocessor control stage has been completely redesigned to provide increased efficiency and greater configuration options. Maximum expandability: the Sentinel Pro is supplied as standard with a USB port and an expansion slot for protocol conversion or relay contacts boards. With energy savings in mind, Sentinel Pro is also fitted with a shut-off button to reduce energy consumption to zero during prolonged periods of inactivity (ECO LINE). Sentinel Pro is available in 700 VA, 1000 VA, 1500 VA, 2200 VA and 3000 VA models.

# Sentinel RT 1-3 kVA/kW



- Power factor 1 kW = kVA
- Simplified installation
- High quality output voltage
- High battery reliability

Sentinel RT is designed to power critical loads such as servers, storage systems, telephone equipment, medical systems and industrial applications. The UPS is ideal for Blade servers with an input power factor close to Unity (1). The UPS has can be used as tower UPS or within a rackmount cabinet and takes up only 2U in height. Sentinel RT has a modern design, choice of functional formats and represents the

**True-ON LINE**  
**Rack/Tower UPS System**  
**1:1** 1-3 kVA/kW  
 Input 100-127 V 60 Hz  
 output 100/110/115/120/127 V 60 Hz



state-of-the-art technology from the Riello UPS research & development team. The UPS can achieve an ON LINE operating efficiency of 92%. For critical business continuity applications requiring long runtimes, Sentinel RT can be installed with battery extension packs. The UPS also incorporates the Riello UPS 'power-off' function found in other ECO Line UPS. Sentinel RT is designed to save energy when no loads are connected.

# Sentinel RT 6-10 kVA/kW



- Power factor 1 kW = kVA
- Simplified installation
- High quality output voltage
- High battery reliability

Sentinel RT is designed to power critical loads such as servers, storage systems, telephone equipment, medical systems and industrial applications. The UPS is ideal for Blade servers with an input power factor close to Unity (1). The UPS has can be used as tower UPS or within a rackmount cabinet and takes up only 2U in height. Sentinel RT has a modern design, choice of functional formats and represents the

**True-ON LINE**  
**Rack/Tower UPS System**  
**1:1** 6-10 kVA/kW  
 Input 208-240 V 60 Hz  
 output 208/220/230/240 V 60 Hz



state-of-the-art technology from the Riello UPS research & development team. The UPS can achieve an ON LINE operating efficiency of 92%. For critical business continuity applications requiring long runtimes, Sentinel RT can be installed with battery extension packs. The UPS also incorporates the Riello UPS 'power-off' function found in other ECO Line UPS. Sentinel RT is designed to save energy when no loads are connected.

# Guard Tower



- Transformer based
- Small footprint
- Power factor 1
- Maintenance bypass
- Galvanic Isolation transformer
- High quality output voltage

Guard Tower is the ideal solution for protecting mission critical systems such as safety devices, telecommunications equipment and IT systems to ensure maximum power reliability. Guard Tower is designed and built using state-of-the-art technology and components to provide maximum protection to the powered loads with no impact on downstream systems and optimised energy savings. The series includes 6-10 kVA/kW single/single-phase output models with ON LINE double conversion technology (VFI): the load is powered continuously by the inverter

which supplies a sinusoidal voltage, filtered and stabilised in terms of form and frequency. Input and output filters provide significant further immunity from mains disturbances and lightning strikes. In terms of technology and performance, Guard Tower is one of the best UPS available on the market today: output power factor 1 to increase in efficiency of system and devices and reduce power system losses. Selectable ECO Mode functions; new custom diagnostics LCD display, RS232 and USB interfaces with PowerShield<sup>3</sup> software, ESD input, interface slot.

## True-ON LINE UPS System

**1:1** 6-10 kVA/kW  
 Input 208-240 V 60 Hz  
 Output 104/110/115/120 V 60 or  
 208/220/230/240 V 60 Hz

|                      |                |             |                      |          |           |
|----------------------|----------------|-------------|----------------------|----------|-----------|
| DATACENTER           | DIGITAL LIVING | E-MEDICAL   | EMERGENCY            | INDUSTRY | TRANSPORT |
| <b>VFI</b><br>ONLINE | Tower          | USB<br>plug | Service<br>1st start |          |           |

# Sentryum S3U



- Efficiency up to 95.5%
- High power availability
- Outstanding battery care
- Compact
- Maximum reliability
- Flexibility of use
- Graphic touch screen display

The Sentryum 10-60 kVA @ 208 V offers the best combination of power availability, energy efficiency and global performance ensuring installation and running cost savings. It is a transformer-free UPS available in 10-20-30-40-50-60 kVA with three-phase input and output. Sentryum is designed and built using state-of-the-art technology and components. It applies the advanced technologies such as DSP (Digital Signal Processor), dual core microprocessor, three-level inverter circuits to provide maximum protection to the critical loads

with no impact on downstream systems, whilst maintaining optimised energy savings. Sentryum provides the solution to installation problems in systems where the power supply has limited power available, when the UPS is supported by a generator or where there are compatibility problems with loads that generate harmonic currents.

**3:3** 10-60 kVA  
 Input 208-220 V three-phase + N, 60 Hz  
 Output 208/220 V three-phase + N, 60 Hz

|                      |           |             |                      |                     |
|----------------------|-----------|-------------|----------------------|---------------------|
| DATACENTER           | E-MEDICAL | EMERGENCY   | INDUSTRY             | TRANSPORT           |
| <b>VFI</b><br>ONLINE | Tower     | USB<br>plug | Service<br>1st start | <b>UL</b><br>LISTED |



## Master HP UL



**3:3** 65-500 kVA  
 Input 480 V three-phase + N, 60 Hz  
 Output 480 V three-phase + N, 60 Hz

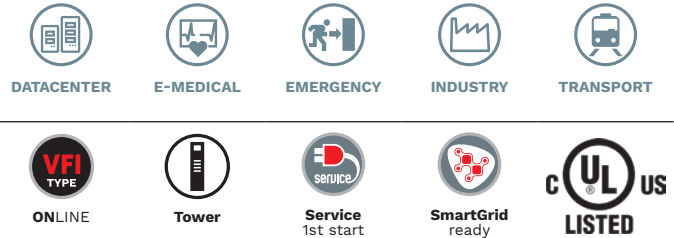

- High efficiency
- IGBT-based rectifier technology
- Compact, reliable and robust
- Galvanic isolation
- High overload capacity

The high levels of quality, reliability and energy savings offered by the Master HP range of UPS, has been extended to include a UL/CSA Listed, 480 V 60 Hz version with ratings from 65 kVA to 500 kVA. More than just an innovative and technologically-advanced UPS, it is a leap into the future of three-phase technology. With its double conversion ON LINE technology based entirely on IGBT and digital signal processors (DSP), the Master HP UL range ensures maximum

critical load protection, with VFI SS 111 classification (Voltage and Frequency Independent) in accordance with IEC EN 62040-3. This range is designed using a new configuration that includes an IGBT sinusoidal input rectifier. Unique in its design, double conversion technology with galvanic isolated output guarantees a quality power supply that is completely protected from all electrical anomalies at the input.

## Master HP FC UL



**3:3** 80-200 kVA  
 Voltage and Frequency Converter  
 Input 480 V three-phase, 60 Hz  
 Output 400 V three-phase + N, 50 Hz

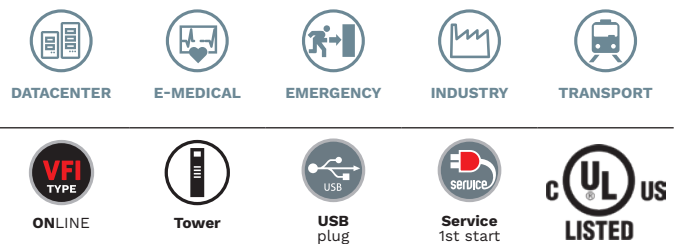

- High efficiency
- IGBT-based rectifier technology
- Output voltage: 400 V - 50 Hz
- Galvanic isolation
- High overload capacity

The high levels of quality, reliability and energy savings offered by the Master HP range of UPS have been extended to include frequency converter 480 V - 60 Hz input / 400 V - 50 Hz output certified as UL, with power ratings from 80 to 200 kVA. The typical application of such Frequency Converters is the power supply of the loads at 400 V, 50 Hz as for example imported from other countries. The FC units can work with or without battery. With its double conversion ON LINE technology based entirely on IGBT and

digital signal processors (DSP), the Master HP FC UL range ensures maximum critical load protection, with VFI SS 111 classification (Voltage and Frequency Independent) in accordance with IEC EN 62040-3. Unique in its design, double conversion technology with galvanic isolated output guarantees a quality power supply that is completely protected from all electrical anomalies at the input.







**CPS**  
**Central Power Supply**



# Central Supply Systems



ONLINE



Tower



Energy Share



USB plug

**EN50171  
COMPLIANT**



**1:1** 3-5 kVA  
**1-3:1** 6-20 kVA  
**3:3** 10-600 kVA

## HIGHLIGHTS

- **Compliance with EN 50171 standard**
- **Dual input**
- **Protection against battery inversion**
- **High recharge current**
- **Continuous overload of 120%\***
- **Enclosure compliant with EN 60598-1 standard**
- **Batteries with 10 year life**

The CSS (Central Supply Systems) range by Riello UPS is designed in compliance with EN 50171 standard and is therefore the ideal solution for installation in buildings subject to fire safety regulations and in particular for the power supply of emergency lighting systems. In addition the CSS range by Riello UPS is also suitable for supplying power to other emergency systems such as automatic fire extinguishing systems, alarm systems and emergency detection systems, smoke extraction equipment and carbon monoxide detection devices as well as dedicated security systems in sensitive areas.

The use of centralised supply systems (CSS) ensures a significant reduction in system set-up and maintenance costs as

well as making periodical checks simpler and faster to perform.

### DUAL INPUT

This important feature allows the mandatory scheduled checks on system operation and autonomy to be carried out with extreme ease and in complete safety by simply operating an input switch. This switch interrupts the power supply to the machine without interrupting the bypass line, which is able to support the load in the event of test failure.

### HIGH RECHARGE CURRENT AND BATTERY CARE SYSTEM

Proper battery care is critical to ensure correct CSS operation in emergency conditions.



The Riello UPS battery care system consists of a series of features and capabilities designed to obtain the best performance, extend operating life and satisfy the recharge times imposed by the standard. The Riello UPS CSS range is designed in compliance with the EN 50171 standard and ensures high current levels are available for the batteries, allowing recharge of up to 80% of full autonomy within 12 hours.

Riello UPS CSS are suitable for use with hermetically sealed lead-acid (VRLA), AGM and GEL, Open Vented and Nickel Cadmium batteries. Different charging methods are available depending on the battery type.

The recharge voltage compensation function based on temperature prevents excessive battery charge and overheating. The deep discharge protection prevents reduced battery performance and battery damage.

**HIGH OVERLOAD CAPACITY**

As required by EN 50171 standard, the Riello UPS CSS range is designed and sized to support continuous overloads (with no time limits) up to 120%\* of the nominal load.

**PROTECTION AGAINST BATTERY INVERSION**

Mandatory in line with EN 50171 standard, protection against battery inversion ensures the safety of those carrying out maintenance operations on the devices and at the same time prevents damage to the system in the event that the batteries are inadvertently connected with the wrong polarity.

**CONTACT INTERFACE**

All models are equipped with a contact interface configured in compliance with the EN 50171 standard.

**GENERAL FEATURES**

In addition to all the already mentioned features, the Riello UPS CSS units can reach up to 600 kVA (with CSS Master, available upon request) and they have the same reliability and flexibility characteristic of the UPS range they derive from. Moreover they also keep the compatibility with the main options and accessories.



**OPERATING MODE**

Every Riello CSS model supports all the operating modes set out and described in EN 50171 standard, as below:

**A Changeover mode**

The load is supplied via the CSS bypass line (always supplied output “AS”).

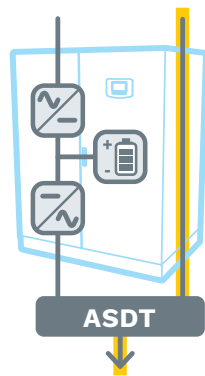

In the event of power supply failure the internal automatic device (ATSD) transfers the load to the inverter. The battery provides power to the inverter, ensuring the required runtime.

**B Mode without interruption**

The load is supplied constantly by the CSS inverter (always supplied output “AS”).

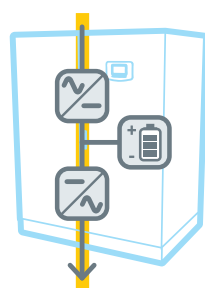

In the event of power supply failure the battery provides power to the inverter, ensuring the required runtime with no interruptions at all.

**C Changeover mode with an additional control switching device for control switching of the load**

In addition to that described in points A and B, the equipment includes one or more switching devices (CSD), which rely on the availability of the normal power supply.

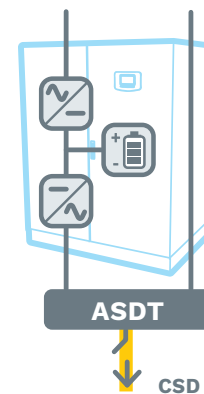

On power supply failure the CSD device connects the load that up until that moment was not supplied (emergency only output “EO”).

**D Changeover mode with an additional control switching device for partial switching of the load**

Differently to that described in point C, part of the load is supplied without interruption whilst the remaining part is only supplied upon power supply failure thanks to the CSD device.



(always supplied + emergency only output “AS+EO”).

\* Referred to power according EN 50171.

\*\*Requires EOS optional accessory

| MODELS   | CSS Sentinel Tower  |       | CSS Sentryum   |                      |                       |                       |                       |
|--|---|-------|--|----------------------|-----------------------|-----------------------|-----------------------|
|  | CAM 3   | CAM 5 | CBM 6 <sup>BAT</sup>   | CBM 8 <sup>BAT</sup> | CBM 10 <sup>BAT</sup> | CBM 15 <sup>BAT</sup> | CBM 20 <sup>BAT</sup> |
| <b>INPUT</b>   |   |       |  |                      |                       |                       |                       |
| Rated voltage [V]  | 220 - 240 (1P+N+PE)   |       | 380 / 400 / 415 three-phase + N - 220 / 230 / 240 single-phase + N   |                      |                       |                       |                       |
| Rated frequency [Hz]   | 50 / 60   |       | 50 / 60  |                      |                       |                       |                       |
| Voltage tolerance [V]  | 230 ±20% @ full load  |       | 230 / 400 ±20% @ full load <sup>1</sup>  |                      |                       |                       |                       |
| Frequency tolerance [Hz]   | 40 - 72   |       | 40 - 72  |                      |                       |                       |                       |
| Power factor @ full load   | ≥ 0.99  |       | 0.99   |                      |                       |                       |                       |
| Current distortion [%]   | ≤ 6   | ≤ 2,5 | ≤ 4  | ≤ 3                  |                       |                       |                       |
| <b>BYPASS</b>  |   |       |  |                      |                       |                       |                       |
| Rated voltage [V]  | 220 / 230 / 240 single-phase + N  |       | 220 / 230 / 240 single-phase + N   |                      |                       |                       |                       |
| Number of phases   | 1 + N   |       | 1 + N  |                      |                       |                       |                       |
| Voltage tolerance (ph-N) [V]   | 180 / 264 (selectable in ECO Mode or SMART ACTIVE Mode)   |       | from 180 (adjustable 180-200) to 264 (adjustable 250-264) referring to neutral   |                      |                       |                       |                       |
| Rated frequency [Hz]   | 50 or 60 (selectable)   |       | 50 or 60 (selectable)  |                      |                       |                       |                       |
| Frequency tolerance [%]  | ±5 (selectable)   |       | ±5% (selectable)   |                      |                       |                       |                       |
| Bypass overload  | 110% continuous, 130% for 60 min, 150% for 10 min   |       | 110% continuous, 125% for 60 min, 150% for 10 min  |                      |                       |                       |                       |
| <b>OUTPUT</b>  |   |       |  |                      |                       |                       |                       |
| Nominal power [kVA]  | 3   | 5     | 6  | 8                    | 10                    | 15                    | 20                    |
| Active power [kW]  | 3   | 5     | 6  | 8                    | 10                    | 15                    | 20                    |
| Power according EN 50171 [kVA/kW]  | 2,5   | 4     | 5  | 6                    | 8                     | 12                    | 16                    |
| Power factor   | 1 up to 40 °C   |       | 1 up to 40 °C  |                      |                       |                       |                       |
| Number of phases   | 1 + N   |       | 1 + N  |                      |                       |                       |                       |
| Rated voltage [V]  | 220 / 230 / 240 single-phase + N (selectable)   |       | 220/ 230 / 240 single-phase + N (selectable)   |                      |                       |                       |                       |
| Rated frequency [Hz]   | 50 or 60  |       | 50 or 60   |                      |                       |                       |                       |
| Frequency stability on battery operation                                     | 0.01%   |       | 0.01%  |                      |                       |                       |                       |
| Voltage stability  | ±1%   |       | ±1%  |                      |                       |                       |                       |
| Dynamic stability  | EN 62040-3 class performance 1 non-linear load  |       | EN 62040-3 class performance 1 non-linear load   |                      |                       |                       |                       |
| Voltage distortion   | < 1 % with linear linear load / ≤ 3 % with non-linear load  |       | <1% with resistive linear load / ≤1.5% with non-linear load  |                      |                       |                       |                       |
| Overload   | 103% continuous, 110% 10 min, 133% 1 min, 150% 5 s  |       | 103% continuous, 110% 60 min, 125% 10 min, 150% 60 s   |                      |                       |                       |                       |
| Inverter overload capacity referred to power according to EN 50171 (@ 40 °C) | 120% infinite   |       | 120% infinite  |                      |                       |                       |                       |
| <b>BATTERIES</b>   |   |       |  |                      |                       |                       |                       |
| Type   | VRLA AGM maintenance-free lead based  |       | VRLA AGM/GEL/NiCd/Li-ion   |                      |                       |                       |                       |
| Recharging method  | One level   |       | One level, Two level, Cyclic recharge (selectable)   |                      |                       |                       |                       |
| <b>OVERALL SPECIFICATIONS</b>  |   |       |  |                      |                       |                       |                       |
| Weight without batteries [kg]  | 24  | 25    | 102  | 103                  | 105                   | 107                   |                       |
| Dimensions (WxDxH) [mm]  | 250x698x500   |       | 440x840x1320   |                      |                       |                       |                       |
| Communications   | LCD display - Slot for communications interface - USB port - R.E.P.O. - 1 Input command - Contact interface with 4 relays   |       | UPS status led bar - Graphic touch screen display - 2 slots for communications interface USB - RS232 - Contact interface with 5x opto insulated Input and 4x Output relays |                      |                       |                       |                       |
| Ambient temp. for the UPS  | 0 °C - +40 °C   |       | 0 °C - +40 °C  |                      |                       |                       |                       |
| Recommended temp. for battery life   | +20 °C - +25 °C   |       | +20 °C - +25 °C  |                      |                       |                       |                       |
| Range of relative humidity   | 5-95% non-condensing  |       | 5-95% non-condensing   |                      |                       |                       |                       |
| Colour   | RAL 9005  |       | RAL 7016   |                      |                       |                       |                       |
| Noise level at 1 m [dBA ±2] ECO Mode   | <48   |       | <40  |                      |                       |                       |                       |
| IP rating  | IP20  |       | IP20   |                      |                       |                       |                       |
| ECO Mode efficiency  | up to 98%   |       | up to 99%  |                      |                       |                       |                       |
| Standards  | European directives: LV 2014/35/EU low voltage Directive EMC 2014/30/EU electromagnetic compatibility Directive Standards: Safety IEC EN 62040-1; EMC IEC EN 62040-2; RoHS compliant Classification in accordance with IEC EN 62040-3 (Voltage Frequency Independent) VFI - SS - 111 - IEC EN 50171 |       |  |                      |                       |                       |                       |
| Moving the CPS   | Castors / pallet jack   |       |  |                      |                       |                       |                       |

<sup>1</sup> For wider tolerance conditions apply.

<sup>BAT</sup> Also available with internal batteries.



| MODELS   | CSS Sentryum  |                       |                       |                       |                       |                       |              |         |         |
|--|---|-----------------------|-----------------------|-----------------------|-----------------------|-----------------------|--------------|---------|---------|
|  | CBT 10 <sup>BAT</sup>   | CBT 15 <sup>BAT</sup> | CBT 20 <sup>BAT</sup> | CBT 30 <sup>BAT</sup> | CBT 40 <sup>BAT</sup> | CBT 60 <sup>BAT</sup> | CBT 80       | CBT 100 | CBT 120 |
| <b>INPUT</b>   |   |                       |                       |                       |                       |                       |              |         |         |
| Rated voltage [V]  | 380 / 400 / 415 three-phase + N   |                       |                       |                       |                       |                       |              |         |         |
| Rated frequency [Hz]   | 50 / 60   |                       |                       |                       |                       |                       |              |         |         |
| Voltage tolerance [V]  | 400 ±20% @ full load <sup>1</sup>   |                       |                       |                       |                       |                       |              |         |         |
| Frequency tolerance [Hz]   | 40 - 72   |                       |                       |                       |                       |                       |              |         |         |
| Power factor @ full load   | 0.99  |                       |                       |                       |                       |                       |              |         |         |
| Current distortion [%]   | ≤3%   |                       |                       |                       |                       |                       |              |         |         |
| <b>BYPASS</b>  |   |                       |                       |                       |                       |                       |              |         |         |
| Rated voltage [V]  | 380 / 400 / 415 three-phase + N   |                       |                       |                       |                       |                       |              |         |         |
| Number of phases   | 3 + N   |                       |                       |                       |                       |                       |              |         |         |
| Voltage tolerance (ph-N) [V]   | from 180 (adjustable 180-200) to 264 (adjustable 250-264) referring to neutral  |                       |                       |                       |                       |                       |              |         |         |
| Rated frequency [Hz]   | 50 or 60 (selectable)   |                       |                       |                       |                       |                       |              |         |         |
| Frequency tolerance [%]  | ±5% (selectable)  |                       |                       |                       |                       |                       |              |         |         |
| Bypass overload  | 110% continuous, 125% for 60 min, 150% for 10 min   |                       |                       |                       |                       |                       |              |         |         |
| <b>OUTPUT</b>  |   |                       |                       |                       |                       |                       |              |         |         |
| Nominal power [kVA]  | 10  | 15                    | 20                    | 30                    | 40                    | 60                    | 80           | 100     | 120     |
| Active power [kW]  | 10  | 15                    | 20                    | 30                    | 40                    | 60                    | 80           | 100     | 120     |
| Power according EN 50171 [kVA/kW]  | 8   | 12                    | 16                    | 24                    | 32                    | 50                    | 65           | 85      | 100     |
| Power factor   | 1 up to 40 °C   |                       |                       |                       |                       |                       |              |         |         |
| Number of phases   | 3 + N   |                       |                       |                       |                       |                       |              |         |         |
| Rated voltage [V]  | 380 <sup>1</sup> / 400 / 415 three-phase + N (selectable)   |                       |                       |                       |                       |                       |              |         |         |
| Rated frequency [Hz]   | 50 or 60  |                       |                       |                       |                       |                       |              |         |         |
| Frequency stability on battery operation                                     | 0.01%   |                       |                       |                       |                       |                       |              |         |         |
| Voltage stability  | ±1%   |                       |                       |                       |                       |                       |              |         |         |
| Dynamic stability  | EN 62040-3 class performance 1 non-linear load  |                       |                       |                       |                       |                       |              |         |         |
| Voltage distortion   | <1% with resistive linear load / ≤1.5% with non-linear load   |                       |                       |                       |                       |                       |              |         |         |
| Overload   | 103% continuous, 110% 60 min, 125% 10 min, 150% 60 sec  |                       |                       |                       |                       |                       |              |         |         |
| Inverter overload capacity referred to power according to EN 50171 (@ 40 °C) | 120% infinite   |                       |                       |                       |                       |                       |              |         |         |
| <b>BATTERIES</b>   |   |                       |                       |                       |                       |                       |              |         |         |
| Type   | VRLA AGM/GEL/NiCd/Li-ion  |                       |                       |                       |                       |                       |              |         |         |
| Recharging method  | One level, Two level, Cyclic recharge (selectable)  |                       |                       |                       |                       |                       |              |         |         |
| <b>OVERALL SPECIFICATIONS</b>  |   |                       |                       |                       |                       |                       |              |         |         |
| Weight without batteries [kg]  | 103   | 105                   | 107                   | 112                   | 116                   | 130                   | 172          | 180     | 198     |
| Dimensions (WxDxH) [mm]  | 440x840x1320  |                       |                       |                       |                       |                       | 500x830x1600 |         |         |
| Communications   | UPS status led bar - Graphic touch screen display - 2 slots for communications interface USB - RS232<br>- Contact interface with 5x opto insulated Input and 4x Output relays   |                       |                       |                       |                       |                       |              |         |         |
| Ambient temperature for the UPS  | 0 °C - +40 °C   |                       |                       |                       |                       |                       |              |         |         |
| Recommended temperature for battery life                                     | +20 °C - +25 °C   |                       |                       |                       |                       |                       |              |         |         |
| Range of relative humidity   | 5-95% non-condensing  |                       |                       |                       |                       |                       |              |         |         |
| Colour   | RAL 7016  |                       |                       |                       |                       |                       |              |         |         |
| Noise level at 1 m [dBA ±2] ECO Mode   | <40   |                       |                       | <50                   |                       |                       | <55          |         |         |
| IP rating  | IP20  |                       |                       |                       |                       |                       |              |         |         |
| ECO Mode efficiency  | up to 99%   |                       |                       |                       |                       |                       |              |         |         |
| Standards  | European directives: LV 2014/35/EU low voltage Directive EMC 2014/30/EU electromagnetic compatibility Directive Standards: Safety IEC EN 62040-1; EMC IEC EN 62040-2; RoHS compliant Classification in accordance with IEC EN 62040-3 (Voltage Frequency Independent) VFI - SS - 111 - IEC EN 50171 |                       |                       |                       |                       |                       |              |         |         |
| Moving the CPS   | Castors / pallet jack   |                       |                       |                       |                       |                       |              |         |         |

<sup>1</sup> For wider tolerance conditions apply.

<sup>BAT</sup> Also available with internal batteries.

DIMENSIONS

CAM 3 - CAM 5

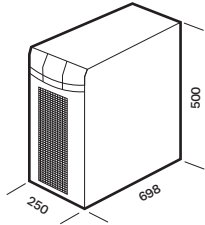

BATTERY CABINET

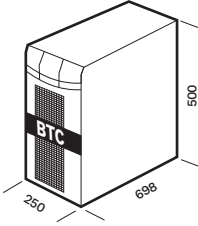
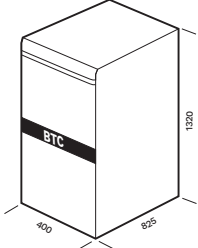
| MODELS  | BTC STW 180V BB L2<br>BTC STW 180V BB R4<br>BTC STW 240V AB A3                      | BTC 1320 180V BB L5 2F<br>BTC 1320 240V AB B1 2F |
|---|---|--|
| <p>Dimensions [mm]</p>  |  |  |

OPTIONS

| SOFTWARE                   |
|----------------------------|
| PowerShield <sup>3</sup>   |
| PowerNetGuard              |
| ACCESSORIES                |
| NETMAN 208                 |
| MULTICOM 302               |
| MULTICOM 352               |
| MULTICOM 372               |
| MULTICOM 384               |
| MULTICOM 411               |
| MULTICOM 421               |
| MULTI I/O                  |
| MULTIPANEL                 |
| Manual Bypass MBB 100 A 2P |

| PRODUCT ACCESSORIES        |
|----------------------------|
| Battery temperature sensor |
| Isolation transformer      |
| Parallel kit               |



DIMENSIONS

**CBM 6 - CBM 8 - CBM 10 - CBM 15 - CBM 20  
CBT 10 - CBT 15 - CBT 20 - CBT 30  
CBT 40 - CBT 60**

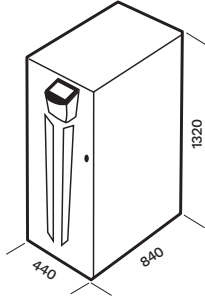

**CBT 80 - CBT 100 - CBT 120**

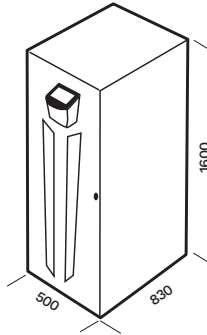

BATTERY CABINET

| MODELS          | BTC 1320 480V BB W4 3F<br>BTC 1320 480V BB W5 3F<br>BTC 1320 480V AB T5 3F | BTC 1320 480V BB W5 3F<br>BTC 1320 480V AB T5 3F              | BTC 1600 480V BB V5 3T<br>BTC 1600 480V AB S5 3T              | BTC 1900 480V BB V6 3T<br>BTC 1900 480V BB V7 3T<br>BTC 1900 480V BB V8 3T<br>BTC 1900 480V BB V9 3T<br>BTC 1900 480V AB V9 3T |
|-----------------|--|---|---|--|
| UPS MODELS      | CBM 6-20 kVA/kW <sup>1</sup><br>CBT 10-40 kVA/kW <sup>1</sup>              | CBM 6-20 kVA/kW <sup>1</sup><br>CBT 10-60 kVA/kW <sup>1</sup> | CBM 6-20 kVA/kW <sup>1</sup><br>CBT 10-80 kVA/kW <sup>1</sup> | CBM 15-20 kVA/KW <sup>1</sup><br>CBT 15-120 kVA/KW <sup>1</sup>  |
| Dimensions [mm] |  |   | <br><i>Conditions apply on CBT 80 kVA/kW CPS model</i>        | <br><i>BTC 1900 480V BB V6 3T and BTC 1900 480V BB V7 3T: Conditions apply on CBT 120 kVA/kW CPS model</i>                     |

<sup>1</sup> According with battery cabinet fuse associated.

OPTIONS

| SOFTWARE                 |
|--------------------------|
| PowerShield <sup>3</sup> |
| PowerNetGuard            |
| ACCESSORIES              |
| NETMAN 208               |
| MULTICOM 302             |
| MULTICOM 352             |
| MULTICOM 384             |
| MULTICOM 411             |

| MULTICOM 421               |
|----------------------------|
| MULTI I/O                  |
| MULTIPANEL                 |
| MBB 100 A 2P               |
| MBB 125 A 4P               |
| MBB 400 A 4P               |
| PRODUCT ACCESSORIES        |
| Battery temperature sensor |
| ER battery charger         |

|   |
|---|
| MULTICOM 392                            |
| CPS with internal isolation transformer |
| IP rating IP21/IP31                     |
| Front door air filter                   |
| Fan failure alarm for 10-40 kVA         |
| Seismic kit                             |
| Parallel kit                            |
| ENERGYMANAGER                           |







# **Transfer Systems**

MANUAL - AUTOMATIC - STATIC



# Manual Transfer Switch

## Multi Pass 10, 16 and 16-R

### MAINTENANCE BYPASS

The Multi Pass manual bypass cuts out UPS in the event of a malfunction or fault. Multi Pass ensures that the connected devices are transferred to mains power before a UPS is switched off or during planned maintenance. Multi Pass is available for rack or wall installations (box).

### FEATURES

- 16 A rack version;
- 10 A and 16 A wall mounted version;
- Standard backfeed protection;
- Multi Pass permits that the connected consumers are manually switched to mains power before a UPS is switched off or before maintenance;
- Mains power present LED indicator;
- Available with different socket standards; (IEC, British socket, terminal boards).



Multi Pass 16 and 16-R

## MBB 100 A 2P, MBB 125 A 4P and MBB 400 A 4P

### MAINTENANCE BYPASS

Riello UPS offers several maintenance bypass solutions with two poles and four poles suitable for single and three-phase applications.

These devices are equipped with three switches to completely isolate the UPS in case of maintenance needs, keeping, at the same time, the load supplied by the mains without any interruption.

All the operations are done safely, thanks to a dedicated auxiliary contact which provides the status of the MBB to the UPS, avoiding any simultaneous supply from the manual bypass and inverter.

**Riello UPS offers a wide range of external bypasses and static switches for UPS up to 800 kVA and for parallel systems up to 6.4 MVA.**



MBB 125 A 4P







# Multi Socket PDU



Plug & Play  
Installation

**1:1** 16 A  
Power Distribution Unit



## HIGHLIGHTS

- **8 programmable output**
- **LCD display**
- **Versatile to use**

The Riello UPS Multi Socket PDU (MDU) is designed to distribute AC power from a single source to 8 outputs with advanced load monitoring and local or remote ON/OFF switching control of individual outlets. The Riello UPS Multi Socket PDU provides best-in-class power distribution, enabling Data Center and information technology (IT) managers to effectively monitor and manage their rack environments. The LCD display allows you to view the status of each output (ON / OFF), the input voltage and current, the current on each output and any alarm codes present. At the top of the display, there are eight icons representing the status of the eight outputs: if the icon is on, the relative output is powered; if icon is off, the relative output is not powered; if the icon is blinking, the relative output is overloaded.

### EXPANDABILITY

The Multi Socket PDU is equipped with an expansion slot for accessory communication boards like, for example, network board NetMan 208. For further information on the accessories available, visit the web site [www.riello-ups.com](http://www.riello-ups.com).

## CHARACTERISTICS

- Input current up to 16 A;
- Maximum output current for a single socket: 4 A;
- LCD display;
- Current threshold for outputs settable by user;
- Voltage and current threshold for input settable by user;
- USB and RS232 communication ports.

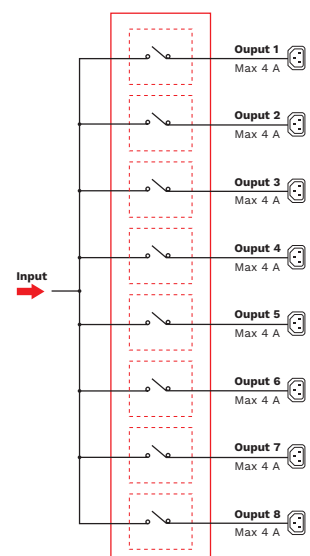

## OPTIONS

### SOFTWARE

PowerShield<sup>3</sup>

### ACCESSORIES

NETMAN 208

MULTICOM 302

MULTICOM 352

## DETAILS

### MDU

#### Front

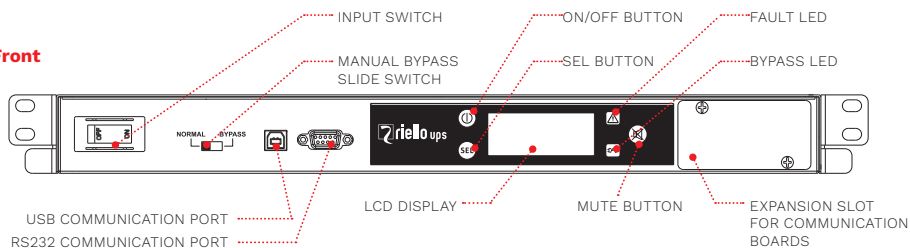

#### Rear

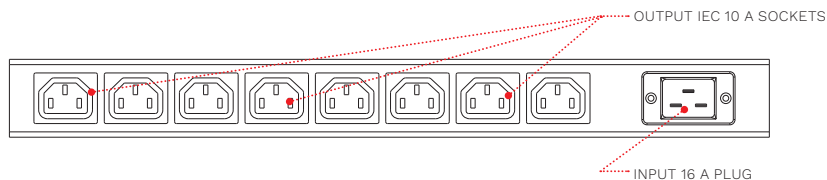

## MODELS

### MDU

#### OPERATING SPECIFICATIONS

Nominal Current [A]

16

Switching time [ms]

<8

#### INPUT

Rated voltage [V]

220 / 230 / 240 single-phase + N

Voltage tolerance [V]

184-276 (selectable)

Switched input phases

Ph+N (two poles)

Rated frequency [Hz]

50 / 60

Input sockets

1x IEC 320 C20 (16 A)

#### OUTPUT

Rated voltage

220 / 230 / 240 single-phase + N

Output sockets

8x IEC 320 C13 (10 A)

Max. load for each output [A]

4

#### OVERALL SPECIFICATIONS

Weight [kg]

5

Dimensions (WxDxH) [mm]

19"x250x1U

Communications

RS232 / USB / Slot for communication interface

Ambient temperature

0 °C - 40 °C

Range of relative humidity

5-95% non-condensing

Colour

RAL 5004

Noise level at 1 m [dBA ±2]

<25

IP rating

IP20

Standards

EN 62310-1 (safety) EN 62310-2 (electro-magnetic compatibility)



# Multi Switch



Plug & Play  
Installation

**1:1 16 A**  
Automatic Transfer Switch



## HIGHLIGHTS

- **Redundant power supply**
- **Load protection**
- **Versatile to use**

The Riello UPS Multi Switch is a high availability and versatile intelligent switch that provides redundant power to connected equipment with two AC input sources. The Riello UPS Multi Switch supplies power to the connected loads from a primary mains source. If that primary source becomes unavailable, the Riello UPS Multi Switch automatically transfers loads to the secondary source. The transfer from one source to the other is performed according to the ITIC (CBEMA) times chart and so it does not impact the operation of the connected equipment. The Riello UPS Multi Switch monitors the current and provides warnings when power consumption draws near the maximum rating which helps prevent downtime to the equipment. Riello UPS Multi Switch has 8 independent IEC 10 A outlets allowing several devices can be plugged directly into the Rack without the need for an additional Rack PDU. The units have a connectivity slot which allows for LAN connection and remote management through PowerShield<sup>3</sup> software, Web interface, SNMP, or SSH which makes the Riello UPS Multi Switch an ideal device for the IT manager who needs flexibility and

protection for their IT equipment. Multi Switch provides installations with power supply continuity. Its operating principle ensures higher reliability than a single UPS, (with or without its own internal bypass).

### OPERATING PRINCIPLE

Multi Switch provides direct distribution of eight 10 A IEC outlets in a system with two input power lines (two mains inputs, or two UPS). Multi Switch is able to connect to either of the two input power lines, whilst simultaneously monitoring the power uptake.

### PROTECTION AGAINST LOAD FAULTS

If one of the loads fails (e.g. short circuit), Multi Switch disconnects the group of sockets where the load is connected, thus preventing other loads from being switched off (i.e. in the event of poor discrimination of the protection devices).

### PROTECTION AGAINST POWER SUPPLY FAULTS

If one of the two power sources falls outside tolerance levels, Multi Switch will transfer the load to the second power source (switching is instantaneous



if the two sources are in phase). Multi Switch units switch power with no impact to IT equipment. Depending on the ITIC curve, typical power supplies will operate 20 ms after AC voltage drops to zero. The IEEE 1100-1999 standard also references the ITIC curve. The SSI (Server System Infrastructure) standard recommends a hold-up time for power supplies to be a minimum of 21 ms for a voltage range of 100-240 V. Multi Switch units switch sources under these industry standard times. The switching time includes the time for the built-in intelligence to determine whether the voltage and frequency are in range. Any point of failure in the electronics does not cause a drop out of the output voltage because the unit incorporates redundancy of its electronic components.

**FEATURES**

- Full protection for loads against mains and load failures;
- Redundant power supply;
- Flexible: Multi Switch can be powered with 2 different power supplies (including 2 UPS of different sizes/types);
- 19" cabinet installation;
- LCD Display panel;
- Compatible with PowerNetGuard supervision software;
- No signal connection between the Multi Switch and the power sources or loads is necessary;
- Slot for communications boards: the optional network card allows for remote in network connectivity and management through HTTP, SNMP and SSH protocol.

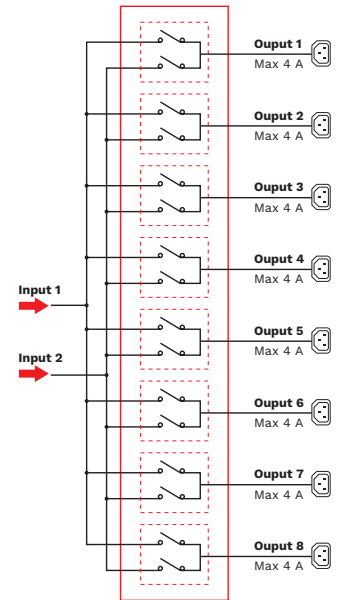

**DETAILS**

**MSW (2 inputs - 8 outputs)**

**Front**

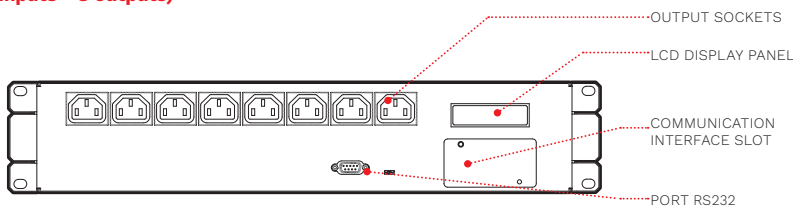

**Rear**

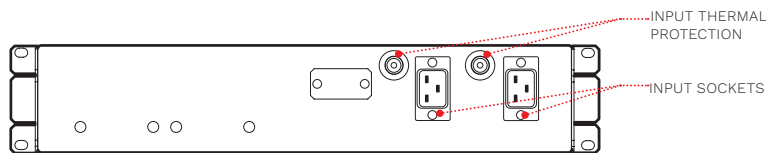

**OPTIONS**

**SOFTWARE**

PowerNetGuard

**ACCESSORIES**

NETMAN 208

**MODELS****MSW****OPERATING SPECIFICATIONS**

|                     |  |
|---------------------|--|
| Nominal Current [A] | 16   |
| Transfer type       | “Break Before Make” (no overlapping sources)             |
| Transfer time [ms]  | < 8 (S1/S2 synchronised) - < 20 (S1/S2 non synchronised) |

**INPUT**

|                                   |                                  |
|-----------------------------------|----------------------------------|
| Rated voltage - sources S1/S2 [V] | 220 / 230 / 240 single-phase + N |
| Voltage tolerance [V]             | 180-276 (selectable)             |
| Switched input phases             | ph+N (two poles)                 |
| Rated Frequency [Hz]              | 50 / 60                          |
| Input sockets                     | 2x IEC 320 C20 (16 A)            |

**OUTPUT**

|                               |                                  |
|-------------------------------|----------------------------------|
| Rated voltage                 | 220 / 230 / 240 single-phase + N |
| Output sockets                | 8x IEC 320 C13 (10 A)            |
| Max. load for each output [A] | 4                                |

**OVERALL SPECIFICATIONS**

|                             |   |
|-----------------------------|---|
| Weight [kg]                 | 10  |
| Dimensions (WxDxH) [mm]     | 19”x360x2U  |
| Communications              | RS232 / Slot for communication interface                        |
| Ambient temperature         | 0 °C - +40 °C   |
| Range of relative humidity  | 5-95% non-condensing  |
| Colour                      | RAL 5004  |
| Noise level at 1 m [dBA ±2] | <35   |
| IP rating                   | IP20  |
| Efficiency @ full load      | > 99%   |
| Standards                   | EN 62310-1 (safety) EN 62310-2 (electro-magnetic compatibility) |









# Multi Switch ATS



Plug & Play  
installation

**1:1** 16-30 A  
Automatic Transfer Switch



## HIGHLIGHTS

- **Redundant power supply**
- **Load protection**
- **Versatile to use**

Riello UPS Multi Switch ATS is a high availability intelligent switch that provides redundant power to connected equipment with two AC input sources. Multi Switch ATS supplies power to the connected loads from a primary mains source. If that primary source becomes unavailable, Multi Switch ATS automatically transfers loads to the secondary source. The transfer from one source to the other is performed according to the ITIC (CBEMA) times chart and so it does not impact the operation of the connected equipment. Multi Switch ATS monitors the current and provides warnings when power consumption draws near the maximum rating which helps prevent downtime to the equipment.

Multi Switch ATS 16 A has 8 IEC 10 A and 1 IEC 16 A outputs, whilst Multi Switch ATS 30 A has 4 IEC 10 A, 1 IEC 16 A outputs and a terminal board allowing several devices to be plugged directly into the ATS without the need for an additional PDU. The units have a connectivity slot which allows for LAN connection and remote management through PowerShield<sup>3</sup> software, Web interface, SNMP, or SSH which makes the Multi Switch ATS an ideal device for

the IT manager who needs flexibility and protection on their IT equipment. Multi Switch ATS provides installations with power supply continuity. Its operating principle ensures higher reliability than a single UPS, (with or without its own internal bypass).

### OPERATING PRINCIPLE

Multi Switch ATS provides direct distribution of eight 10 A IEC outputs or one 16 A IEC output in the 16 A model, four 10 A IEC outputs one 16 A IEC output or a terminal board in the 30 A model in a system with two input power lines (two mains inputs, or two UPS). Multi Switch ATS is able to connect to either of the two input power lines, whilst simultaneously monitoring the power uptake.

### PROTECTION AGAINST LOAD FAULTS

If one of the loads fails (e.g. short circuit), the Multi Switch ATS disconnects the group of sockets where the load is connected, thus preventing other loads from being switched off (i.e. in the event of poor discrimination of the protection devices).



**PROTECTION AGAINST POWER SUPPLY FAULTS**

If one of the two power sources falls outside tolerance levels, Multi Switch ATS will transfer the load to the second power source (switching is instantaneous if the two sources are in phase). Multi Switch ATS units switch power with no impact to IT equipment. Depending on the ITIC curve, typical power supplies will operate 20 ms after AC voltage drops to zero. The IEEE 1100-1999 standard also references the ITIC curve. The SSI (Server System Infrastructure) standard recommends a hold-up time for power supplies to be a minimum of 21 ms for a voltage range of 100-240 V. Multi Switch ATS units switch sources under these industry standard times. The switching time includes the time for the built-in intelligence to determine whether the voltage and frequency are in range. Any point of failure in the electronics does not cause a drop out of the output voltage because the unit incorporates redundancy of its electronic circuitry to avoid fault tolerance.

**FEATURES**

- Full protection for loads against mains and load failures;
  - Redundant power supply;
  - Versatile to use: Multi Switch ATS can be powered with 2 different power supplies (including 2 UPS of different sizes/types);
  - 19" cabinet installation;
  - Display panel;
  - No signal connection between the Multi Switch ATS and the power sources or loads is necessary;
  - Compatible with PowerShield<sup>3</sup> software
- Slot for communications boards: the optional network card allows for remote in network connectivity and management through HTTP, SNMP and SSH protocol.

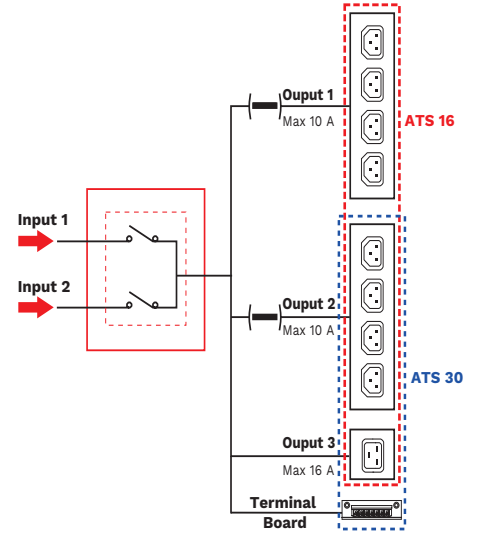

**DETAILS**

**MTA**

**MTA 16 A e 30 A (front)**

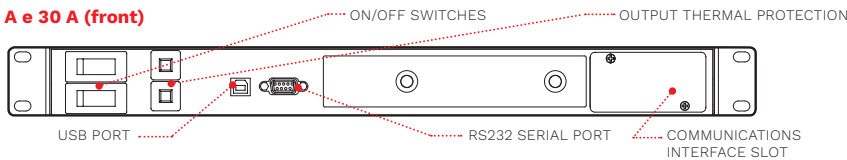

**MTA 16 A (rear)**

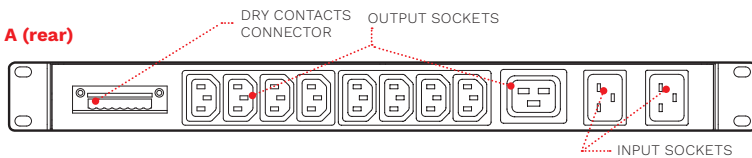

**MTA 30 A (rear)**

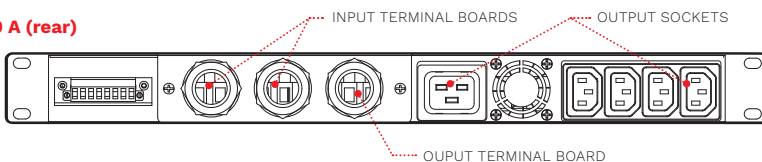

**OPTIONS**

**SOFTWARE**

PowerShield<sup>3</sup>

**ACCESSORIES**

- NETMAN 208
- MULTICOM 302
- MULTICOM 352
- MULTICOM 411
- MULTICOM 421

| <b>MODELS</b>                     | <b>MTA 16</b>  | <b>MTA 30</b>   |
|-----------------------------------|--|---|
| <b>OPERATING SPECIFICATIONS</b>   |  |   |
| Nominal Current [A]               | 16   | 30  |
| Transfer type                     | "Break Before Make" (no overlapping sources)                         |   |
| Transfer time [ms]                | <8 (S1/S2 synchronised) - <20 (S1/S2 non synchronised)               |   |
| <b>INPUT</b>                      |  |   |
| Rated voltage - sources S1/S2 [V] | 220 / 230 / 240 single-phase + N                                     |   |
| Voltage tolerance [V]             | 180-276 (selectable)   | 180-264 (selectable)  |
| Switched input phases             | ph+N (two poles)   |   |
| Rated Frequency [Hz]              | 50 / 60  |   |
| Input sockets                     | 2x IEC 320 C20 (16 A)  | Terminal boards   |
| <b>OUTPUT</b>                     |  |   |
| Rated voltage                     | 220 / 230 / 240 single-phase + N                                     |   |
| Output sockets                    | 4+4 IEC 320 C13 (10 A)<br>+ 1x IEC 320 C19 (16 A)                    | 4x IEC 320 C13 (10 A) + 1x IEC 320 C19 (16 A)<br>+ terminal board |
| Max. load for each output [A]     | 10 (IEC 320 C13) - 16 (IEC 320 C19) - 30 (terminal board)            |   |
| <b>OVERALL SPECIFICATIONS</b>     |  |   |
| Weight [kg]                       | 5  |   |
| Dimensions (WxDxH) [mm]           | 19"x330x1U   |   |
| Communications                    | RS232 / USB / Slot for communication interface / Relay contacts port |   |
| Ambient temperature               | 0 °C - +40 °C  |   |
| Range of relative humidity        | 5-95% non-condensing   |   |
| Colour                            | RAL 5004   |   |
| Noise level at 1 m [dBA ±2]       | <35  |   |
| IP rating                         | IP20   |   |
| Efficiency @ full load            | >99%   |   |
| Standards                         | EN 62310-1 (safety) EN 62310-2 (electro-magnetic compatibility)      |   |



# Master Switch STS

## SINGLE-PHASE



DATACENTER



E-MEDICAL



INDUSTRY



TRANSPORT



Plug & Play  
Installation

**1:1** 32-63-120 A  
Static Transfer Switch



### HIGHLIGHTS

- **Operating flexibility**
- **Load protection**
- **Complete diagnostics**
- **Hot Swap function**

Master Switch Single-phase (MMS) is part of the Master Switch range and offers solutions suitable for protecting single-phase loads with different power ratings. MMS is available in three sizes: 32, 63 and 120 A and is therefore able to satisfy various requirements for the protection of single-phase loads.

#### **FLEXIBILITY OF USE**

All MMS versions are designed with criteria that facilitate on-site installation as well as diagnostics, control and maintenance operations. All models are equipped with a manual bypass and the hot swap function allows for rapid corrective interventions by non-specialised personnel in the event of faults.

#### **LOAD PROTECTION**

With MMS transfer switch loads are protected against critical environmental situations and mains power interference. Microprocessor control and the use of thyristor static switches ensure continuous monitoring of the power supply sources and reduced switching times between the two sources in the event of a fault. The constant monitoring

of the output current allows for the rapid identification of any short circuit currents in the consumers, preventing short circuits from propagating to other loads. MMS is equipped with thermal-magnetic protection for the two sources, ensuring rapid intervention in the event of faults and integrated backfeed protection. MMS ensures switching times between the two power sources of less than a quarter of a cycle, both in the event of manual switching and in the event of automatic switching triggered by a fault in the power source.

#### **COMPLETE DIAGNOSTICS**

All MMS versions are equipped with 32-character LCD displays and control panels with multi-function keys. This allows for rapid and intuitive monitoring of supply readings, switch status and environmental conditions. MMS is equipped with three standard programmable dry contacts, an input for emergency shutdown, a RS232 serial connection and a slot for housing the expansion board, thus ensuring complete availability of interface solutions for remote control and monitoring.



## OPTIONS

### SOFTWARE

PowerShield<sup>3</sup>

### ACCESSORIES

NETMAN 208

MULTICOM 302

MULTICOM 352

MULTICOM 411

MULTICOM 421

## DETAILS

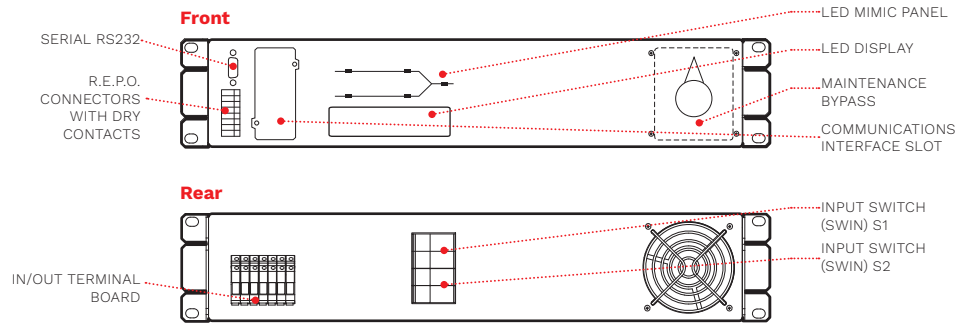

## HOT SWAP REPLACEMENT



Carry out manual bypass operation on faulty unit selecting S1 or S2



Remove the screws placed on left/right side and extract the unit

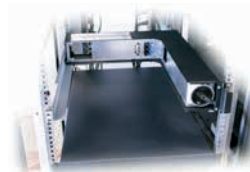

Replace the faulty unit with a new one



Fix the parts, follows start up procedure and return back from manual bypass

All operations are carefully described on operating manual.

| MODELS                                      | MMS 32  | MMS 63 | MMS 120    |
|---|---|--------|------------|
| <b>OPERATING SPECIFICATIONS</b>             |   |        |            |
| Nominal Current [A]                         | 32  | 63     | 120        |
| Transfer type                               | "Break Before Make" (no overlapping sources)                    |        |            |
| Available transfer methods                  | Automatic / Manual / Remote                                     |        |            |
| Transfer time [ms]                          | <4 (S1/S2 synchronised) - <10 (S1/S2 non synchronised)          |        |            |
| Replacement                                 | Hot Swap  |        |            |
| <b>INPUT</b>                                |   |        |            |
| Rated voltage - sources S1/S2 [V]           | 220 / 230 / 240 single-phase + N                                |        |            |
| Voltage tolerance [V]                       | 180-264 (selectable)  |        |            |
| Switched input phases                       | Ph+N (two poles)  |        |            |
| Rated frequency [Hz]                        | 50 / 60   |        |            |
| Input frequency tolerance range             | ±10% (selectable)   |        |            |
| Distribution compatibility IT, TT, TNS, TNC | IT, TT, TNS, TNC  |        |            |
| <b>OVERALL SPECIFICATIONS</b>               |   |        |            |
| Weight [kg]                                 | 10  | 12     | 20         |
| Dimensions (WxDxH) [mm]                     | 19"x520x2U  |        | 19"x520x3U |
| Communications                              | RS232 / Slot for communication interface / Relay contacts port  |        |            |
| Ambient temperature                         | 0 °C - +40 °C   |        |            |
| Range of relative humidity                  | 5-95% non-condensing  |        |            |
| Colour                                      | RAL 7016  |        |            |
| Noise level at 1 m [dBA ±2]                 | <40   |        |            |
| IP rating                                   | IP20  |        |            |
| Efficiency @ full load                      | >99%  |        |            |
| Standards                                   | EN 62310-1 (safety) EN 62310-2 (electro-magnetic compatibility) |        |            |

# Master Switch STS

## THREE-PHASE



DATACENTER



E-MEDICAL



INDUSTRY



TRANSPORT



Service  
1st start



**3:3** 100-800 A  
Static Transfer Switch

### HIGHLIGHTS

- **High reliability**
- **Hot Replacement function**
- **3 or 4 poles version**
- **Advanced communications**

Installing a Master Switch static transfer switch provides additional resilience and protection from the disruption that can be caused by the failure of a single power source. The result is the absolute protection of industrial utilities and critical information technology against power supply and load faults.

#### OPERATING PRINCIPLE

Master Switch guarantees a source of redundant power, allowing the load to be switched between to alternative and independent power sources. Switching can be automatic (when a supply source falls outside of acceptable tolerances) or manually done by an operator from the front panel or remotely.

#### PROTECTION AGAINST POWER SUPPLY FAULTS

If one of the two power sources falls outside tolerance levels, Master Switch will transfer the consumers to the second power source (switching is instantaneous if the two sources are in phase).

#### PROTECTION AGAINST ENVIRONMENTAL DISTURBANCES

In the event of an overload, the user can decide the level of intervention of the internal protection devices in order to block the power supply. In the extreme case of a downstream short circuit, Master Switch disconnects the load in order to avoid jeopardising the operation of the other loads (i.e. in the event of poor selectivity of the protection devices).





## TOTAL MICROPROCESSOR CONTROL

Microprocessor control logic ensures:

- Fast and safe switching between power sources;
- Monitoring of all parameters via LCD display;
- Constant monitoring of SCR operation
- Advanced remote diagnostics (RS232 and TCP/IP).

## REDUNDANT DESIGN

Power is supplied to the internal logic by two physically separate supply circuits that are fully independent and that can be replaced in “hot replacement” mode without causing power supply interruptions to the load. In the event that the power supplied by both sources fails, full system operation is guaranteed by the “Power Supply back up” function, which provides auxiliary power supply to the circuits from an external, independent power source. Master Switch is equipped with a dual redundant ventilation system known as: “fan redundancy plus”. Thanks to this feature and in the unlikely event that two fans fail at the same time, those remaining would still be able to dissipate the heat generated at nominal load and with an ambient temperature of up to 40° C. Also the fans can be replaced in “hot replacement” mode, ensuring continuity during the replacement operation.

## SUPERIOR PROTECTION

In the event of an output short circuit, Master Switch blocks the transfer between the two power sources, eliminating the risk of propagating the short circuit and its effects to the other loads. A backfeed control circuit ensures the automatic intervention of the protection devices when a return of power to one of the two Master Switch inputs is detected.

## ACCESSIBILITY

The layout of the moving components and parts is designed to ensure easy frontal access:

- power cable connections that are easily accessed with entry from below;
- boards housed in a dedicated area for rapid diagnosis / replacement;
- all parts subject to monitoring, maintenance and/or replacement.

## ADVANCED COMMUNICATIONS

Master Switch provides information, measurements, statuses and alarms via the LCD display. The STS is compatible with PowerShield<sup>3</sup> supervision and shutdown software for Windows operating systems 11, 10, 8, Server 2022, 2019, 2016 and previous versions, Windows Server Virtualization Hyper-V, macOS, Linux, Citrix XenServer and other Unix operating systems.

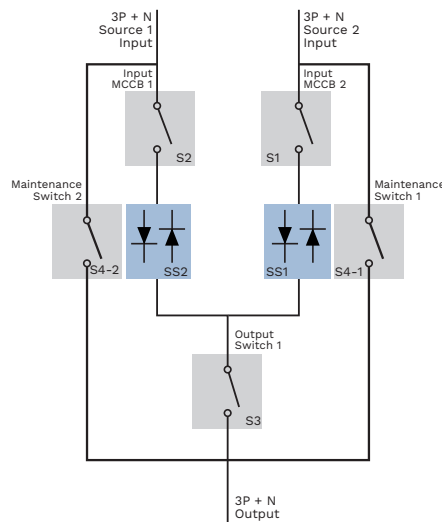

## OPTIONS

### SOFTWARE

PowerShield<sup>3</sup>

### ACCESSORIES

NETMAN 208\*

MULTICOM 302\*

MULTICOM 352\*

MULTICOM 411\*

MULTICOM 421\*

### PRODUCT ACCESSORIES (ALL EX-WORK)

“No neutral on input” kit

Power Supply Back-up

RS232 Duplexer

Top Entry Cabinet

\*Communication card adapter needed.

| LEDs | FUNCTION                          |
|------|-----------------------------------|
| L1   | S1 Priority Source                |
| L2   | S2 Priority Source                |
| L3   | S1 Present                        |
| L4   | S2 Present                        |
| L5   | Static transfer switch SS1 closed |
| L6   | Static transfer switch SS2 closed |
| L7   | Alarm indicator                   |
| L8   | Output selector ON/OFF            |

**5 function keys and LCD operation**

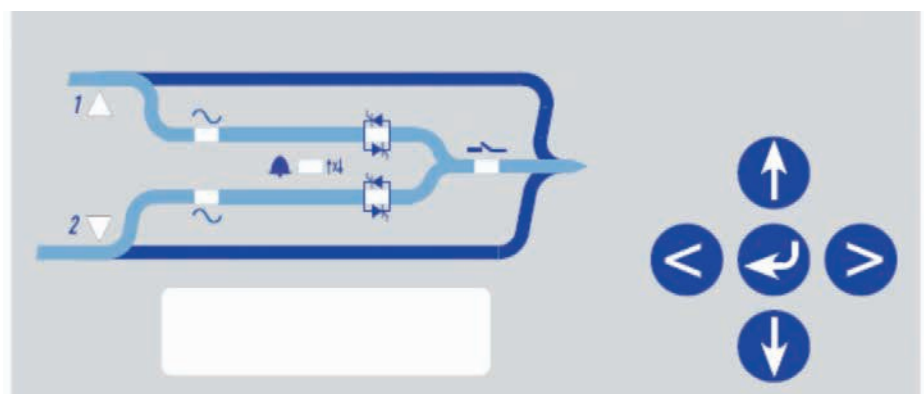

## MASTER SWITCH IN REDUNDANT MODE

The secondary power source [AS], although highly reliable, only powers the load in the event of a failure with the priority power source [PS], ensuring maximum redundancy and power quality to the loads.

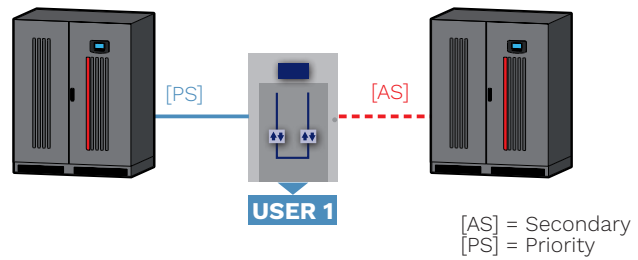

## MASTER SWITCH IN CROSS FEEDING MODE

The two sources power critical loads using Master Switches configured to selected one of the two power sources as the priority source [PS]. In case of a failure in one of two sources, the other will be able to supply power to all the loads connected to the system.

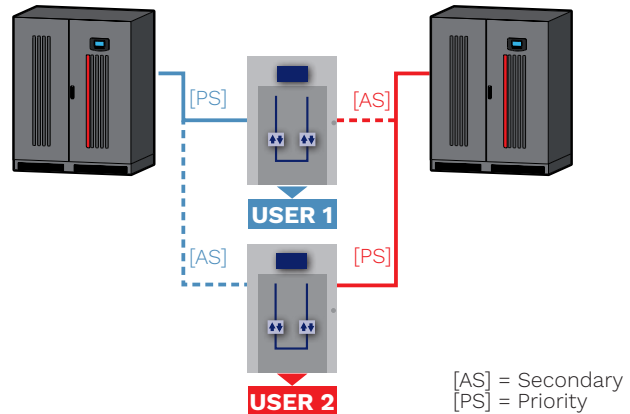

## MASTER SWITCH IN BACK-UP MODE

Master Switches power utilities via the priority energy source [PS]; the secondary energy source [AS] is made up of independent, separate power sources and to make up for any faults in the priority power source [PS].

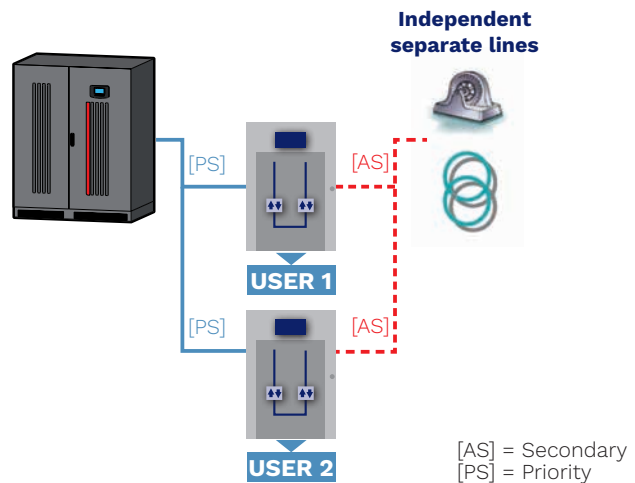

## DYNAMIC DUAL BUS CONFIGURATION

The Riello UPS solution guarantees maximum reliability and ensures continuity of power supply under all operating conditions thanks to the UGS option that keeps the two systems, A and B, perfectly synchronised. The flexibility of the UGS system ensures synchronism between the sources even when one of the two systems is not a Riello UPS model, but made by another manufacturer, or when the input sources are not from uninterruptible power supplies.

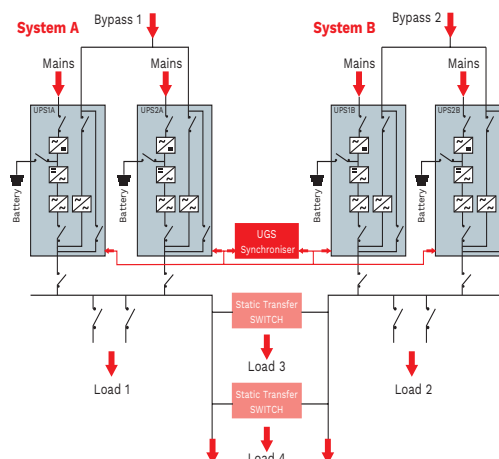

## DIMENSIONS

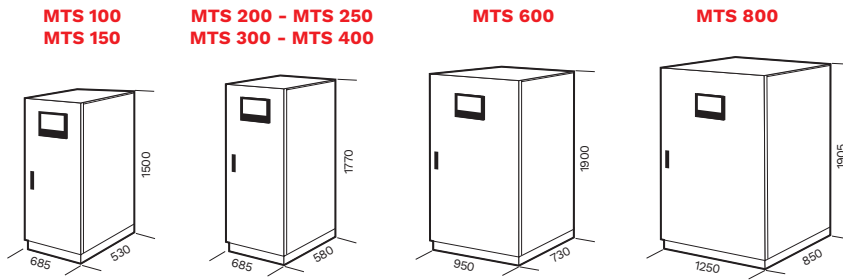

| MODELS                            | MTS 100   | MTS 150 | MTS 200      | MTS 250 | MTS 300 | MTS 400 | MTS 600      | MTS 800       |  |
|-----------------------------------|---|---------|--------------|---------|---------|---------|--------------|---------------|--|
| <b>OPERATING SPECIFICATIONS</b>   |   |         |              |         |         |         |              |               |  |
| Nominal Current [A]               | 100   | 150     | 200          | 250     | 300     | 400     | 600          | 800           |  |
| Transfer type                     | "Break Before Make" (no overlapping sources)                    |         |              |         |         |         |              |               |  |
| Available transfer methods        | Automatic / Manual / Remote                                     |         |              |         |         |         |              |               |  |
| Transfer time [ms]                | <4 (S1/S2 synchronised) 10 (S1/S2 non synchronised)             |         |              |         |         |         |              |               |  |
| <b>INPUT</b>                      |   |         |              |         |         |         |              |               |  |
| Rated voltage - sources S1/S2 [V] | 380 / 400 / 415 three-phase + N                                 |         |              |         |         |         |              |               |  |
| Voltage tolerance [V]             | 180 / 264 (selectable)  |         |              |         |         |         |              |               |  |
| Switched input phases             | 3 ph+N (four poles version) - 3 ph (three poles version)        |         |              |         |         |         |              |               |  |
| Rated frequency [Hz]              | 50 / 60   |         |              |         |         |         |              |               |  |
| Input frequency tolerance range   | ±10% (selectable)   |         |              |         |         |         |              |               |  |
| Distribution compatibility        | IT, TT, TNS, TNC  |         |              |         |         |         |              |               |  |
| <b>OVERALL SPECIFICATIONS</b>     |   |         |              |         |         |         |              |               |  |
| Weight [kg] three poles version   | 145   | 165     | 195          | 205     | 230     | 240     | 340          | 515           |  |
| Weight [kg] four poles version    | 175   | 190     | 205          | 235     | 240     | 255     | 375          | 560           |  |
| Dimensions (WxDxH) [mm]           | 685x530x1500  |         | 685x580x1770 |         |         |         | 950x730x1900 | 1250x850x1905 |  |
| Communications                    | RS232 / Relay contacts port                                     |         |              |         |         |         |              |               |  |
| Ambient temperature               | 0 °C - +40 °C   |         |              |         |         |         |              |               |  |
| Range of relative humidity        | 5-95% non-condensing  |         |              |         |         |         |              |               |  |
| Colour                            | RAL 7024  |         |              |         |         |         |              |               |  |
| Noise level at 1 m [dBA ±2]       | <55   |         |              |         |         |         | <60          | <62           |  |
| IP rating                         | IP20  |         |              |         |         |         |              |               |  |
| Efficiency @ full load            | > 99%   |         |              |         |         |         |              |               |  |
| Standards                         | EN 62310-1 (safety) EN 62310-2 (electro-magnetic compatibility) |         |              |         |         |         |              |               |  |
| Moving the STS                    | Pallet jack   |         |              |         |         |         |              |               |  |

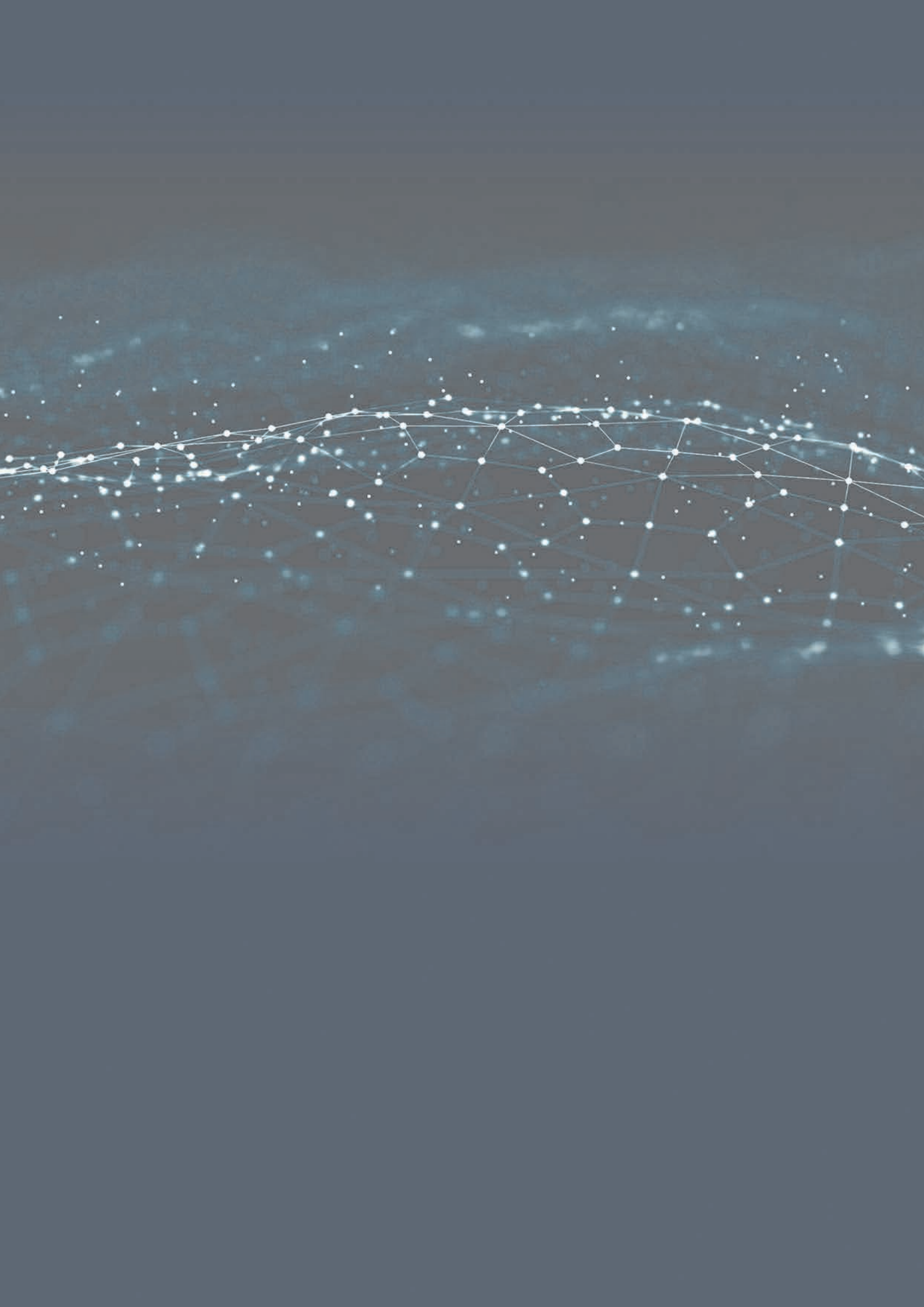



**Special Solutions**



DATACENTER



E-MEDICAL



INDUSTRY

# SuperCaps UPS

SOLUTIONS WITH SUPERCAPACITORS



ONLINE

**1:1** 1-10 kVA  
**3:3** 10-400 kVA



## HIGHLIGHTS

### Clean energy

An eco-friendly, battery-free uninterruptible power system.

### High efficiency innovative technology

Modular expansion options for more power and runtime.

### Long operating life

5 to 10 times standard lead batteries.

### High number of cycles

Million vs. ca 300 of lead batteries.

### Low maintenance costs

Easy to install and maintain.

### High working temperature

No need of cooling or heating systems.

### Low footprint & weight

SuperCaps UPS are a type of uninterruptible power supply developed by Riello UPS which use super capacitors to accumulate energy instead of conventional batteries. It delivers autonomy in the range of seconds (1 to 60 sec). The innovative Riello SuperCaps UPS is designed to provide complete power supply protection for sensitive and mission critical loads, protecting them from mains disturbances and providing sufficient power to compensate for interruptions in mains supply.

Traditionally UPS rely on batteries for accumulating energy, but at least 87% of power supply interruptions last for less than a second<sup>(1)</sup>. SuperCaps UPS provide greater energy efficiency, lower costs and reduced footprints – ideal for installations where floor space is at a premium. At the heart of the Riello SuperCaps UPS is a sophisticated control system that manages the charge-discharge cycle of

the super-capacitors and optimises their lifecycle, which may exceed a million cycles. Their back-up time is dependent on the load but is sufficient to supply it until the mains power is restored or until reserve power from a generator starts automatically.

Most UPS are installed as standard with batteries lasting 5-10 minutes to protect the load against generator start up failure. For modern data centers, electro-medical and industrial applications, an efficient generator set supported by a UPS with a relatively brief autonomy offers the most efficient and effective power continuity solution, with conventional batteries providing sufficient runtime to cover most power interruptions. However, SuperCaps UPS do not have batteries and therefore provide long term savings in terms of battery installation, monitoring, maintenance, replacement and recycling costs. In addition, when compared to the



5-7 years lifespan of standard batteries, SuperCaps UPS have a theoretically infinite life.

These cost savings, along with the reduced footprint make SuperCaps UPS the ideal solution for critical installations that are particularly sensitive to short power supply interruptions.

<sup>1</sup>Electric Power Research Institute study.

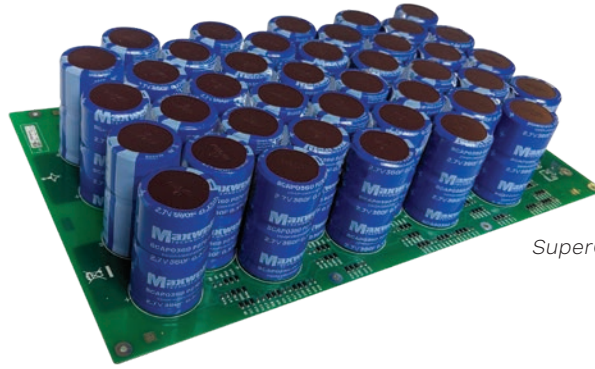

SuperCaps module.

## SENTINELPROSC

| MODELS        |                            | SEP 1000 C1            | SEP 3000 C2 |
|---------------|----------------------------|------------------------|-------------|
| <b>INPUT</b>  | Rated voltage [V]          | 220 / 230 / 240 1 ph+N |             |
|               | Rated frequency [Hz]       | 50 / 60                |             |
|               | Power factor               | >0.99                  |             |
|               | Current distortion         | ≤7%                    |             |
| <b>OUTPUT</b> | Nominal power [VA]         | 1000                   | 3000        |
|               | Power [W]                  | 900                    | 2700        |
|               | Rated voltage [V]          | 220 / 230 / 240 1 ph+N |             |
| <b>BACKUP</b> | <b>Autonomy [s]</b>        | <b>8</b>               | <b>7</b>    |
|               | <b>Recharge time [min]</b> | <b>2</b>               |             |
| <b>DATA</b>   | Net weight [kg]            | 8.1                    | 17.6        |
|               | Dimensions (WxDxH) [mm]    | 158x422x235            | 190x446x333 |

Note: Back-up time is calculated at 70% load (W).

## SENTINELTOWERSC

| MODELS        |                            | STW 6000 C3 ER         | STW 10000 C4 ER                                     |
|---------------|----------------------------|------------------------|---|
| <b>INPUT</b>  | Rated voltage [V]          | 220 / 230 / 240 1 ph+N | 220 / 230 / 240 1 ph+N<br>or 380 / 400 / 415 3 ph+N |
|               | Rated frequency [Hz]       | 50 / 60                |   |
|               | Power factor               | >0.99                  |   |
|               | Current distortion         | ≤5%                    |   |
| <b>OUTPUT</b> | Nominal power [VA]         | 6000                   | 10000   |
|               | Power [W]                  | 6000                   | 10000   |
|               | Rated voltage [V]          | 220 / 230 / 240 1 ph+N |   |
| <b>BACKUP</b> | <b>Autonomy [s]</b>        | <b>8</b>               | <b>7</b>  |
|               | <b>Recharge time [min]</b> | <b>2</b>               |   |
| <b>DATA</b>   | Net weight [kg]            | 45                     | 46  |
|               | Dimensions (WxDxH) [mm]    | 250x698x500            |   |

Note: Back-up time is calculated at 70% load (W).

## SENTRYUMSC

| MODELS        |                            | S3M 10<br>XTD C5                              | S3M 10<br>XTD C6 | S3M 15<br>XTD C5 | S3M 15<br>XTD C7 | S3M 20<br>XTD C6 | S3M 20<br>XTD C8 |
|---------------|----------------------------|---|------------------|------------------|------------------|------------------|------------------|
| <b>INPUT</b>  | Rated voltage [V]          | 220 / 230 / 240 1 ph+N 380 / 400 / 415 3 ph+N |                  |                  |                  |                  |                  |
|               | Rated frequency [Hz]       | 50 / 60                                       |                  |                  |                  |                  |                  |
|               | Power factor               | >0.99   |                  |                  |                  |                  |                  |
|               | Current distortion         | ≤3%   |                  |                  |                  |                  |                  |
| <b>OUTPUT</b> | Nominal power [kVA]        | 10  | 10               | 15               | 15               | 20               | 20               |
|               | Power [kW]                 | 10  | 10               | 15               | 15               | 20               | 20               |
|               | Rated voltage [V]          | 220 / 230 / 240 1 ph+N                        |                  |                  |                  |                  |                  |
| <b>BACKUP</b> | <b>Autonomy [s]</b>        | <b>14</b>                                     | <b>30</b>        | <b>8</b>         | <b>30</b>        | <b>14</b>        | <b>30</b>        |
|               | <b>Recharge time [min]</b> | <b>2</b>                                      | <b>4</b>         | <b>2</b>         | <b>5</b>         | <b>4</b>         | <b>7</b>         |
| <b>DATA</b>   | Net weight [kg]            | 130   | 151              | 132              | 180              | 155              | 202              |
|               | Dimensions (WxDxH) [mm]    | 440x840x1320                                  |                  |                  |                  |                  |                  |

| MODELS        |                            | S3T 10<br>XTD C5       | S3T 10<br>XTD C6 | S3T 15<br>XTD C5 | S3T 15<br>XTD C7 | S3T 20<br>XTD C6 | S3T 20<br>XTD C8 |
|---------------|----------------------------|------------------------|------------------|------------------|------------------|------------------|------------------|
| <b>INPUT</b>  | Rated voltage [V]          | 380 / 400 / 415 3 ph+N |                  |                  |                  |                  |                  |
|               | Rated frequency [Hz]       | 50 / 60                |                  |                  |                  |                  |                  |
|               | Power factor               | >0.99                  |                  |                  |                  |                  |                  |
|               | Current distortion         | ≤3%                    |                  |                  |                  |                  |                  |
| <b>OUTPUT</b> | Nominal power [kVA]        | 10                     | 10               | 15               | 15               | 20               | 20               |
|               | Power [kW]                 | 10                     | 10               | 15               | 15               | 20               | 20               |
|               | Rated voltage [V]          | 380 / 400 / 415 3 ph+N |                  |                  |                  |                  |                  |
| <b>BACKUP</b> | <b>Autonomy [s]</b>        | <b>14</b>              | <b>30</b>        | <b>8</b>         | <b>30</b>        | <b>14</b>        | <b>30</b>        |
|               | <b>Recharge time [min]</b> | <b>2</b>               | <b>4</b>         | <b>2</b>         | <b>5</b>         | <b>4</b>         | <b>7</b>         |
| <b>DATA</b>   | Net weight [kg]            | 130                    | 151              | 132              | 180              | 155              | 202              |
|               | Dimensions (WxDxH) [mm]    | 440x840x1320           |                  |                  |                  |                  |                  |

| MODELS        |                            | S3T 30<br>XTD C6       | S3T 30<br>XTD C8 | S3T 40<br>XTD C6 | S3T 40<br>XTD C8 | S3T 60 SC +<br>BTC 1320 648V<br>BB C7 3F | S3T 80 SC +<br>BTC 1320 648V<br>BB C8 3F |
|---------------|----------------------------|------------------------|------------------|------------------|------------------|--|--|
| <b>INPUT</b>  | Rated voltage [V]          | 380 / 400 / 415 3 ph+N |                  |                  |                  |  |  |
|               | Rated frequency [Hz]       | 50 / 60                |                  |                  |                  |  |  |
|               | Power factor               | >0.99                  |                  |                  |                  |  |  |
|               | Current distortion         | ≤3%                    |                  |                  |                  |  |  |
| <b>OUTPUT</b> | Nominal power [kVA]        | 30                     | 30               | 40               | 40               | 60                                       | 80                                       |
|               | Power [kW]                 | 30                     | 30               | 40               | 40               | 60                                       | 80                                       |
|               | Rated voltage [V]          | 380 / 400 / 415 3 ph+N |                  |                  |                  |  |  |
| <b>BACKUP</b> | <b>Autonomy [s]</b>        | <b>10</b>              | <b>20</b>        | <b>7</b>         | <b>15</b>        | <b>7</b>                                 | <b>7</b>                                 |
|               | <b>Recharge time [min]</b> | <b>4</b>               | <b>7</b>         | <b>3</b>         | <b>5</b>         | <b>3</b>                                 | <b>3</b>                                 |
| <b>DATA</b>   | Net weight [kg]            | 160                    | 207              | 164              | 211              | 190+148                                  | 200+168                                  |
|               | Dimensions (WxDxH) [mm]    | 440x840x1320           |                  |                  |                  | (500x830x1600) +<br>(400x825x1320)       |  |

Note: Back-up time is calculated at 100% load (W).





## MASTERMPSSC

| MODELS                            | MPT 60 SC +<br>BTC 1900 480V<br>BB CD 2T | MPT 80 SC +<br>BTC 1900 480V<br>BB CD 2T | MPT 100 SC +<br>BTC 1900 480V<br>BB CD 2T | MPT 120 SC +<br>BTC 1900 480V<br>BB CD 2T | MPT 160 SC +<br>BTC 1900 480V<br>BB CE 2T |
|-----------------------------------|--|--|---|---|---|
| <b>INPUT</b> Rated voltage [V]    | 380 / 400 / 415 3 ph+N                   |  |   |   |   |
| Rated frequency [Hz]              | 50 / 60                                  |  |   |   |   |
| Power factor                      | >0.9 (HC version)                        |  |   |   |   |
| Current distortion                | <5% (HC version)                         |  |   |   |   |
| <b>OUTPUT</b> Nominal power [kVA] | 60                                       | 80                                       | 100                                       | 120                                       | 160                                       |
| Power [kW]                        | 54                                       | 72                                       | 90  | 108                                       | 144                                       |
| Rated voltage [V]                 | 380 / 400 / 415 3 ph+N                   |  |   |   |   |
| <b>BACKUP</b> Autonomy [s]        | <b>20</b>                                | <b>15</b>                                | <b>11</b>                                 | <b>10</b>                                 | <b>15</b>                                 |
| Recharge time [min]               | <b>6</b>                                 | <b>4</b>                                 | <b>4</b>                                  | <b>3</b>                                  | <b>4</b>                                  |
| <b>DATA</b> Net weight [kg]       | 460+395                                  | 520+395                                  | 620+395                                   | 640+395                                   | 700+540                                   |
| Dimensions (WxDxH) [mm]           | (800x740x1400) + (860x800x1900)          |  | (800x800x1900) + (860x800x1900)           |   |   |

Note: Back-up time is calculated at 100% load (W).

## MASTERHPSC

| MODELS                            | MHT 100 SC + BTC<br>1900 624V BB C9 2T | MHT 120 SC + BTC<br>1900 624V BB C9 2T | MHT 160 SC + BTC<br>1900 624V BB CA 2T | MHT 200 SC + BTC<br>1900 624V BB CA 2T |
|-----------------------------------|--|--|--|--|
| <b>INPUT</b> Rated voltage [V]    | 380 / 400 / 415 3 ph+N                 |  |  |  |
| Rated frequency [Hz]              | 50 / 60                                |  |  |  |
| Power factor                      | >0.99                                  |  |  |  |
| Current distortion                | ≤3%                                    |  |  |  |
| <b>OUTPUT</b> Nominal power [kVA] | 100                                    | 120                                    | 160                                    | 200                                    |
| Power [kW]                        | 90                                     | 108                                    | 144                                    | 180                                    |
| Rated voltage [V]                 | 380 / 400 / 415 3 ph+N                 |  |  |  |
| <b>BACKUP</b> Autonomy [s]        | <b>14</b>                              | <b>10</b>                              | <b>18</b>                              | <b>14</b>                              |
| Recharge time [min]               | <b>3</b>                               | <b>2</b>                               | <b>4</b>                               | <b>3</b>                               |
| <b>DATA</b> Net weight [kg]       | 700+435                                | 755+435                                | 830+625                                | 965+625                                |
| Dimensions (WxDxH) [mm]           | (800x850x1900) + (860x800x1900)        |  | (1000x850x1900) + (860x800x1900)       |  |

Note: Back-up time is calculated at 100% load (W).

## NEXTENERGYSC

| MODELS                            | NXE 250 SB SC +<br>BTC 1900 624V<br>BB CA 2T | NXE 300 SB SC +<br>2x BTC 1900<br>624V BB CA 2T | NXE 400 SB SC +<br>2x BTC 1900<br>624V BB CA 2T | NXE 500 SB SC +<br>2x BTC 1900<br>624V BB CA 2T | NXE 600 SB SC +<br>3x BTC 1900<br>624V BB CA 2T | NXE 800 SB SC +<br>4x BTC 1900<br>624V BB CA 2T |
|-----------------------------------|--|---|---|---|---|---|
| <b>INPUT</b> Rated voltage [V]    | 380 / 400 / 415 3 ph+N                       |   |   |   |   |   |
| Rated frequency [Hz]              | 50 / 60                                      |   |   |   |   |   |
| Power factor                      | >0.99  |   |   |   |   |   |
| Current distortion                | ≤3%  |   |   |   |   |   |
| <b>OUTPUT</b> Nominal power [kVA] | 250  | 300   | 400   | 500   | 600   | 800   |
| Power [kW]                        | 250  | 300   | 400   | 500   | 600   | 800   |
| Rated voltage [V]                 | 380 / 400 / 415 3 ph+N                       |   |   |   |   |   |
| <b>BACKUP</b> Autonomy [s]        | <b>8</b>                                     | <b>18</b>                                       | <b>13</b>                                       | <b>10</b>                                       | <b>13</b>                                       | <b>13</b>                                       |
| Recharge time [min]               | <b>5</b>                                     | <b>5</b>  | <b>4</b>  | <b>4</b>  | <b>4</b>  | <b>4</b>  |
| <b>DATA</b> Net weight [kg]       | 635+625                                      | 890+2x625                                       | 1100+2x625                                      | 1300+2x625                                      | 1600+3x625                                      | 1985+4x625                                      |
| Dimensions (WxDxH) [mm]           | (800x850x1900)<br>+ (860x800x1900)           | (1200x850x1900)<br>+ 2x<br>(860x800x1900)       | (1400x850x1900)<br>+ 2x<br>(860x800x1900)       | (1600x850x1900)<br>+ 2x<br>(860x800x1900)       | (2000x850x1900)<br>+ 3x<br>(860x800x1900)       | (2400x850x1900)<br>+ 4x<br>(860x800x1900)       |

Note: Back-up time is calculated at 100% load (W).

# Lithium Battery Solutions

UPS AND ENERGY STORAGE SYSTEMS (ESS)  
POWERED BY LITHIUM BATTERY SOLUTIONS



DATACENTER



E-MEDICAL



INDUSTRY



TRANSPORT



Energy  
Storage



## HIGHLIGHTS

### Extended Battery Life

Longer than lead acid batteries.

### High Temperatures Tolerance

Cooling system downsized, money saving.

### High Energy Density

Footprint minimizing and weight reducing.

### Real Time Monitoring System

Safety, reliability and information management improves.

### High Number of Cycles

11,000 vs 300 for traditional lead acid batteries.

### High Rate Performance

Higher charging/discharging current (up to 2.5 C / 11 C).

### Capacity Performance

Higher capacity retention than lead acid batteries.

**Lithium batteries offer all types of facility operators a new set of solutions to help improve their energy storage performance. Lithium batteries are the ideal solution for all applications requiring a high number of cycles, high rate performance, new concepts of facility operating modes such as “peak shaving” or where there are very limited space and temperature constraints.**

Thanks to the chemical and technological advances made during the last 10 years, Riello UPS introduce lithium battery solutions that are a valid alternative to the conventional lead acid battery for a wide range of usages.

The innovative lithium technology available from Riello UPS provides several advantages over traditional lead acid battery solutions, starting with the smaller number (or even the absence) of

replacements for the entire duration of the UPS and ESS installation life cycle, which reduces or eliminates the risk of interruptions due to replacement of the batteries and granting an important cost saving. Lead acid batteries require a managed room temperature around 20/25 °C, which has a high impact on cooling system design. The lithium battery has a greater tolerance to high temperatures (including casual spikes) and if the UPSs / ESSs and servers are also designed to tolerate higher operating temperature, it is possible to save money, downsizing the cooling system and reducing the electricity costs.

Furthermore, for the same amount of energy supplied their weight is reduced by more than half, which makes them more manageable and easier to position. The footprint is reduced by up to 75% of conventional lead acid batteries, leaving



free space for additional IT equipment or additional room to accommodate future power upgrades.

Unlike lead acid batteries, the capacity does not degrade as a function of the discharging current rate: in case a high discharging current is required, the cell capacity is maintained, no oversizing is required and a high cost saving is achieved. The number of charging / discharging cycles is increased over 10 times, depending on the technology, temperature and depth of discharge.

This is a fundamental feature to enable UPS/ESS applications requiring a high number of battery cycles as “peak shaving” and “OFF GRID configuration”.

The charging times, which are essential in the various blackout scenarios, are at least four times faster and this must be taken into account in a smart grid and smart energy perspective; for instance in all hybrid installations (grid/GE + solar + wind) that requires higher charging / discharging rate.

Because such technology require electrical cell balancing, the Riello UPS lithium

battery solution integrates a sophisticated Battery Monitoring System (typically not part of a lead acid battery solution for UPS systems) that guarantees improvements in the performance, safety and reliability of the batteries, as well as enabling full system supervision.

Riello UPS lithium solutions are compatible with much of the Riello UPS product series portfolio and easily adaptable to any customer needs in terms of power, architecture and installation requirements.

### EXTENSIVE RANGE OF SOLUTIONS

The Riello UPS lithium battery proposal incorporates several solutions spanning a large number of application requirements that meet the most pressing market demands. This is achieved through a series of products that are characterised by discharging duration time, number of battery cycles and charging / discharging current rate.

The Riello UPS lithium battery proposal is suitable for:

- Data centers (e.g., co-location, control rooms);
- Telecom (e.g. fixed and mobile operator);
- Healthcare (e.g., hospitals and medical centers);
- Building infrastructures (e.g., financial institutions, education centers);
- Transportation (e.g., railway and airport infrastructure);
- Manufacturing (e.g., food & beverage industry);
- Energy storage (e.g., photovoltaic, wind and cogeneration applications, smart grid and OFF GRID applications).

### THE RIELLO UPS LITHIUM BATTERY PROPOSAL

The Riello UPS lithium battery solution offers a full proposal that includes:

- Battery Modules with integrated electronic control;
- Battery breaker protection;
- BMS unit;
- Interconnection power cables between modules;
- Internal cabinet communication cables;
- External communication cable for data exchange between the BMS unit and Riello UPS system.

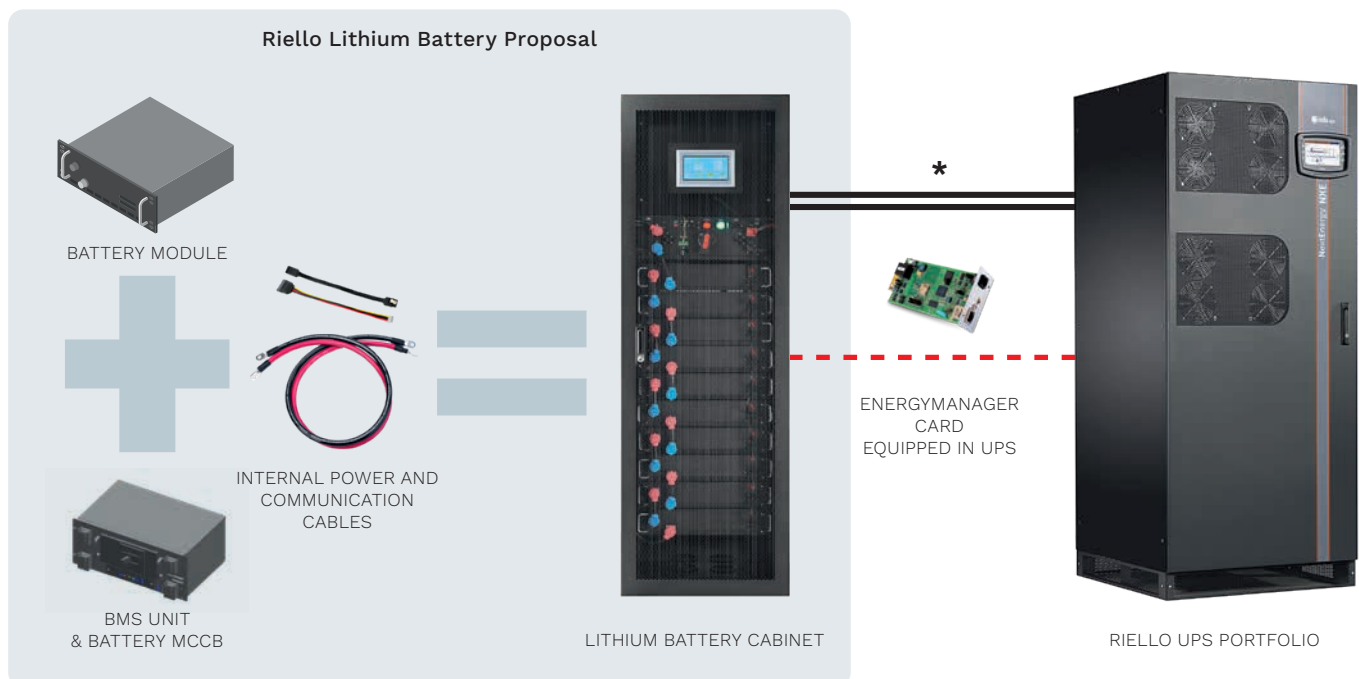

\* Power cables between Battery cabinet and Riello UPS are not supplied.

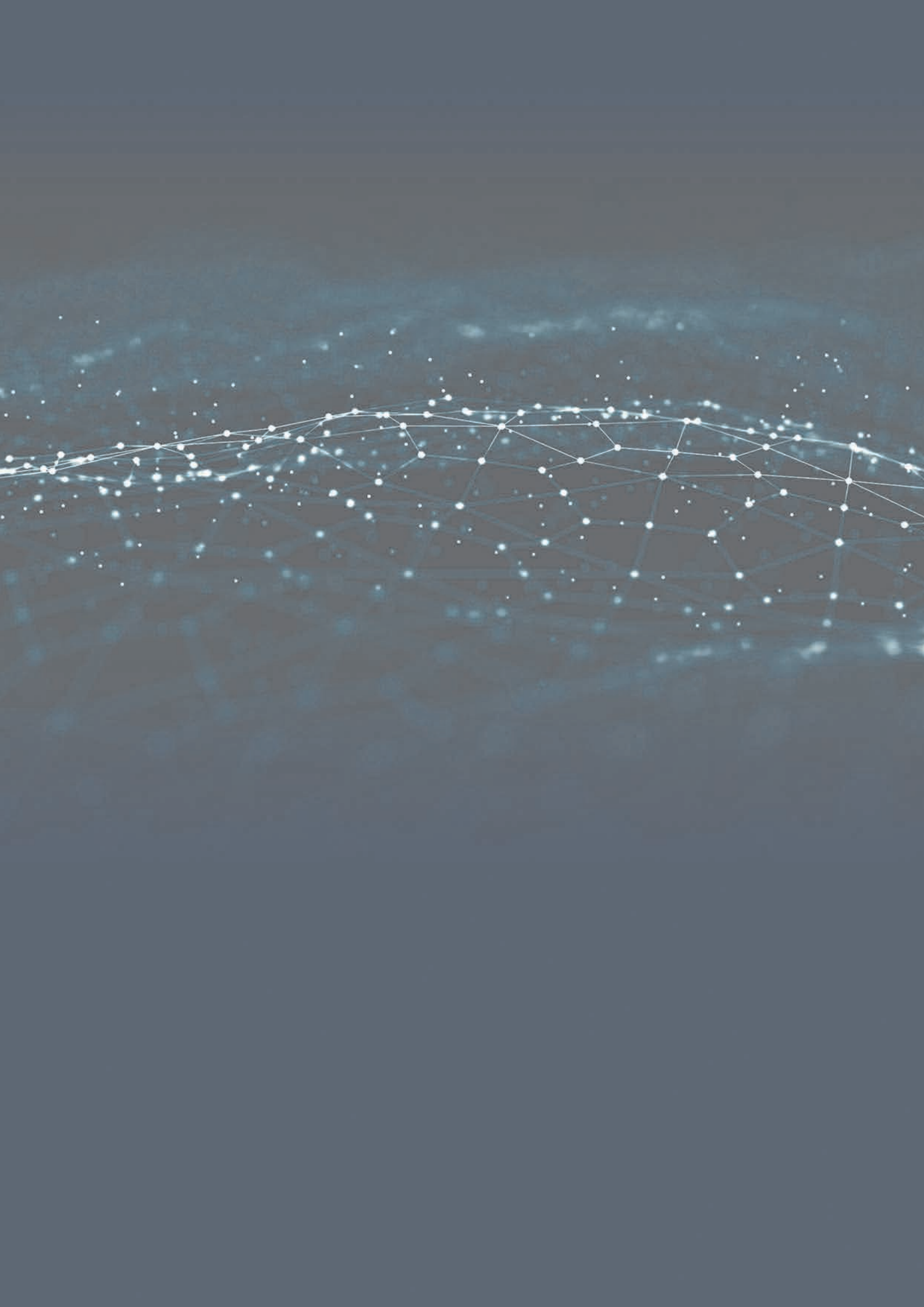



**Software and  
Connectivity**

# PowerShield<sup>3</sup>

SHUTDOWN SOFTWARE

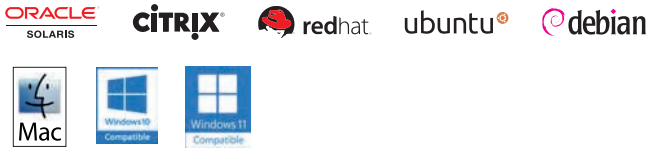

## HIGHLIGHTS

### Graphic monitoring of UPS and environmental sensor status

PowerShield<sup>3</sup> is a simple but powerful UPS management tool. A graphic version is available for all operating systems.

### Detailed display of all UPS and environmental sensor parameters

PowerShield<sup>3</sup> provides all the information required for first level diagnostics.

### Events log and graphic display of main parameters

All changes in UPS operating states are logged, as well as the main physical values and parameters. These constantly recorded values are displayed in graphic format.

### UPS control programming

This allows you to automate all the actions normally carried out by the user: turning the server on and off, UPS battery test, etc.

### Block diagram of operation

A display of UPS operation in the form of a block diagram makes the analysis of UPS operating states more intuitive.

PowerShield<sup>3</sup> provides efficient, user-friendly UPS management, displaying all major operational information such as input voltage, applied load and battery charge. The software also provides detailed information on fault conditions and UPS operating states. Developed with a client/server architecture, it is the ideal tool for managing multi-platform network systems.

## FEATURES

- PowerShield<sup>3</sup> free version: supports a single UPS for the operating systems;
- PowerShield<sup>3</sup> full version: supports up to maximum of 32 UPS for all operating systems;
- With sequential and priority-based shutdown, PowerShield<sup>3</sup> provides unattended shutdown of all networked PCs, saving any active work on the most widely used applications. Users can define the shutdown priorities for the various computers in the network and can also customise the procedure;
- With multi-platform compatibility, PowerShield<sup>3</sup> uses the TCP/IP communications protocol to achieve standardised management and monitoring across the widest possible range of platforms. This makes it possible to monitor computers with different operating systems from a single console, for example monitoring a UNIX server from a PC running Windows and also connecting to UPS located in different geographical areas using dedicated networks (intranets) or the Internet;
- With event scheduling, PowerShield<sup>3</sup> users can program their own shutdown procedures, detailing power-off and power-up scenarios to increase system security and save energy;
- With messages management, PowerShield<sup>3</sup> keeps users constantly informed about the status of UPS and environmental sensors, either locally or via network messages. A list can also be defined of users who should receive e-mails, faxes, voice messages and SMS messages when faults or sudden mains power supply failures occur;
- Integrated SNMP agent: PowerShield<sup>3</sup> features an integrated SNMP agent for UPS management which can send all the information required and generate traps using

the RFC1628 standard and environmental sensors;

- Secure, easy to use and connect, communication is now password protected to ensure UPS system security. Using the new discovery/ browsing function, all UPS connected to a protected computer and/or LAN can be displayed in a list format for monitoring. In the absence of a LAN connection, support is provided for modem-based communication.

## DEVELOPED FOR VIRTUALISED SYSTEMS

PowerShield<sup>3</sup> permits to initiate live migration of virtual machines (VM) to automatically and transparently migrate VMs during power disturbance to protected devices by UPS with migration systems such as Microsoft Live Migration. PowerShield<sup>3</sup> can monitor and manage UPS either inside or outside the Data Center. Can also measure power consumption to help calculate power usage effectiveness (PUE), the standard metric utilised for gauging data center power efficiency.

## SUPPORTED OPERATING SYSTEMS

- Windows 11, 10, 8, Server 2022, 2019, 2016 and previous versions, Windows Server Virtualization Hyper-V;
- Microsoft Hyper-V and Microsoft SCVMM™;
- Linux on X86, X86\_64 and IA64 processors;
- Mac OS X, Citrix® XenServer and Xen® open source platforms;
- The most common UNIX operating systems such as: IBM AIX, HP, SUN Solaris INTEL and SPARC, SCO Unixware and Open Server, Silicon Graphics IRIX, Compaq Tru64 UNIX and DEC UNIX, Open BSD UNIX and FreeBSD UNIX, NCR UNIX;
- HP OPEN VMS.

**PowerShield<sup>3</sup> is available for download at [www.riello-ups.com](http://www.riello-ups.com)**



# PowerNetGuard

INVENTORY MANAGER SOFTWARE



## HIGHLIGHTS

### Graphic monitoring of ups and environmental sensor status

PowerNetGuard is a simple but powerful UPS management and display tool. A graphic version is available for all operating systems.

### Detailed display of all UPS and environmental sensor parameters

PowerNetGuard provides all the information required for first level diagnostics.

### Events log and graphic display of main parameters

All changes in UPS operating states are logged, as well as the main physical values and parameters. These constantly recorded values are displayed in graphic format.

### Centralised Management

PowerNetGuard is the ideal solution for managing all UPS in an infrastructure using a single application. With this one application you can monitor and manage all your UPS, ensuring prompt warnings in the event of faults or malfunctions.

### Support for third party UPS

PowerNetGuard also allows you to manage UPS made by other manufacturers via SNMP using their own network boards. This allows you to centralise the management of the UPS fleet into a single system without the need for many different applications, simplifying management and use.

PowerNetGuard software centralises UPS management using network interface (SNMP) communications. It is ideal for Data Center EDP managers and medium to large-sized networks. Using the RFC1628 Management Information Base (MIB), it ensures standardised management for all UPS compliant with this worldwide standard.

## FEATURES

- Centralised control of remote UPS via Ethernet with SNMP v1 and v3 protocol;
- Multi-level display of geographical areas, building plans, maps, etc.;
- Multi-user access with various security levels;
- Compatible with NetMan and RFC1628 standard SNMP agents;
- Creation of graphs of input and output values and data back-up to file;
- Alarm notifications via e-mail and SMS
- Windows 11, 10, 8, Server 2022, 2019, 2016 and previous versions, Windows Server Virtualization Hyper-V.

**PowerNetGuard is available for download at [www.riello-ups.com](http://www.riello-ups.com)**

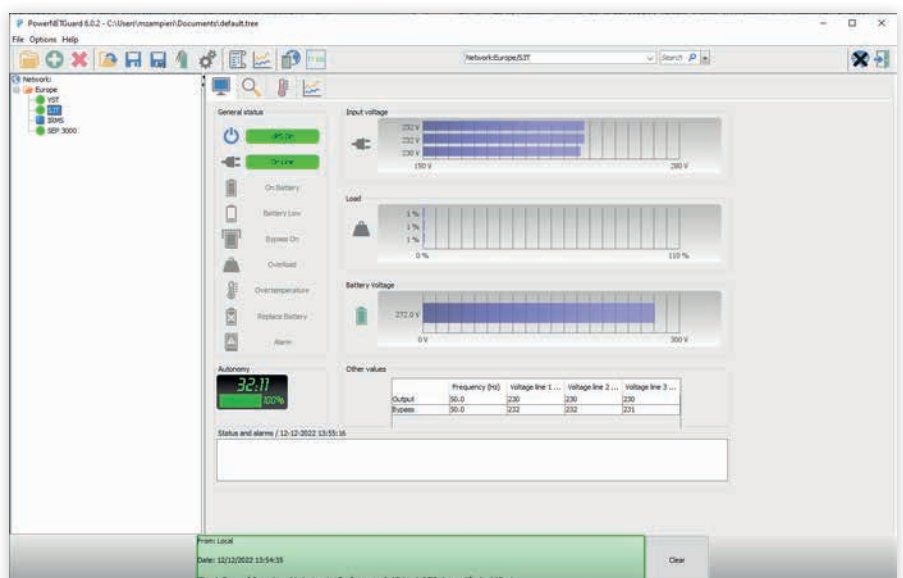

# Accessories

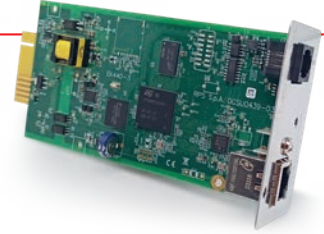

## NetMan 208

### CARD - ETHERNET - SNMP

The NetMan 208 network card allows UPS directly connected over LAN 10/100/1000 Mb connections to be managed using the main network communication protocols (TCP/IP, HTTP and SNMP). It is the ideal solution for the integration of UPS over Ethernet networks with Modbus/TCP or BACNET/IP protocols. It was developed to integrate UPS into medium-sized and large networks, to provide a high level of reliability in communication between the UPS and associated management systems.



### FEATURES

- 32 bit RISC dual core processor;
- Compatible with 10/100/1000 Mbps Ethernet and IPv4/6 networks;
- Compatible with PowerShield<sup>3</sup> and PowerNetGuard;
- SNMP v1, v2 and v3 with RFC1628 for PowerNetGuard and NMS connection;
- SNMP v1, v2 and v3 with RFC3433 for the management of environmental sensors;
- HTTPS for UPS control via web browser;
- SMTP for alarm notifications and UPS status updates via email;
- Ldap and Active Directory integration for centralised authentication mechanism support;
- Permits to initiate live migration of virtual machines (VM) to automatically and transparently migrate VMs during power

disturbance to protected devices by UPS with migration systems such as VMware and vMotion™. NetMan 208 can monitor and manage UPS either inside or outside the data center. Can also measure power consumption to help calculate power usage effectiveness (PUE), the standard metric utilised for gauging Data Center power efficiency.

- Modbus/TCP;
- BACNET/IP;
- Maximum expandability;
- Events log and data management;
- Wake-on-LAN management for starting computers via TCP/IP network;
- Other standards: DHCP, DNS, RARP, FTP, NTP, ICMP, IGMP;
- Management of environmental sensors;
- Configurable via SSH sessions and web;
- Firmware upgradeable via web browser;
- Configurable firewall.

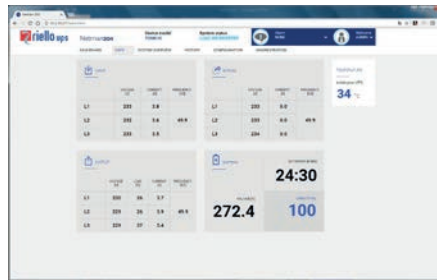

## Environmental sensor

### FOR NETMAN 208

The NetMan 208 environmental sensors is able to monitor and record environmental conditions, as well as activities in protected areas and the area where the UPS is installed. The environmental sensors allow management and control to be extended to cover the area around the UPS, monitoring the temperature and humidity and driving cooling fans or locks. Values are provided via Internet, SNMP and via PowerShield<sup>3</sup> software. PowerShield<sup>3</sup>

can be used to manage sensor operating states in order to send messages. Refer to PowerShield<sup>3</sup> software documentation for further information. NetMan 208 can manage up to 3 separate sensors. Environmental sensors are quick to install thanks to their small footprint and they do not require a separate external power supply. Thanks to the self-learning sensors, configuration is also rapid and intuitive.



### Available sensor:

-55 +60 °C Temperature 0-100% humidity Sensor and I/O digital 0-12 Vdc In, 1 A max Out at 48 Vdc Sensor.





## MultiCom 302

### CARD - MODBUS/JBUS INTERFACE

The MultiCom 302 protocol converter allows UPS monitoring using the MODBUS/JBUS protocol over RS232 or RS485 serial lines. In addition, it also manages a second independent RS232 serial line that can be used to connect to other devices such as the PLC or a PC running PowerShield<sup>3</sup> software.

#### FEATURES

- Port configuration for MODBUS/JBUS as RS232 or RS485;
- Management of two independent serial lines;
- Suitable for integration with the main BMS management programs.



## MultiCom 352

### CARD - INTERFACE DUPLEXER

The MultiCom 352 serial duplicator is an accessory that allows two devices to be connected to a single communication serial port on the UPS. It can be used anywhere where several serial connections are required for multiple polling of the UPS. It is ideal for LAN networks with firewalls, where a high level of security is required, or for the management of separate LAN networks supplied by a single UPS.

#### FEATURES

- Cascading configuration giving a maximum of 4 serial communication ports;
- LED communication flow indicator;
- Firmware upgradeable via serial port.



## MultiCom 372

### CARD - RS232 INTERFACE

The MultiCom 372 allows an additional communication port to be added to the UPS to control and monitor the UPS via the RS232 serial line.

The board is supplied with an ESD (UPS Emergency Shutdown) input and an RSD (Remote Shutdown) input, both available on a removable terminal board and directly connectible to emergency buttons or other buttons.

#### FEATURES

- Management of ESD input and UPS Shut-down;
- Ability to supply devices at 12 V 80 mA max.



## MultiCom 384

### CARD - RELAY I/O INTERFACE

The MultiCom 384 provides a set of relay contacts for managing UPS alarm notifications and operating states. The board has two removable terminal boards. One of these terminal boards includes the ESD (UPS Emergency Shut Down) and RSD (Remote Shut Down) signals. The board also provides the possibility of associating Battery Working, Bypass, Alarm and

Battery Low warnings with potential free contacts on normally close or normally open contacts.

#### FEATURES

- Max. current 3 A at 250 V;
- Signal-contact customisation;
- Normally Open or Normally Close configuration for each contact.



## MultiCom 392

### SLOT EXPANDER NETWORK CARD

MultiCom 392 is a communications card that provides 8 configurable dry contact outputs and up to 4 inputs to assist with monitoring and control of the UPS.

Device is compatible with a broad range of Riello UPS models, including Multi Power, Multi Sentry, Sentryum and our Central Supply Systems (CSS).

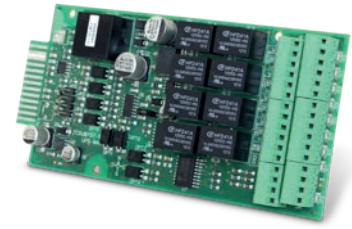

## MultiCom 411

### PROFIBUS PROTOCOL CONVERTER

The MultiCom 411 connects a Riello UPS to a Profibus DP Network. In industrial environments, the Gateway integrates UPS management and monitoring into a control system.

The Gateway uses the field bus design, one of the most popular used for communicating between devices such as automation control systems and distributed I/O hardware.



## MultiCom 421

### PROFINET PROTOCOL CONVERTER

The MultiCom 421 connects a Riello UPS to a PROFINET-IO Network. In industrial environments, the Gateway integrates UPS management and monitoring into a control system. The Gateway uses the PROFINET

control system, one of the most popular used for communicating between devices such as automation control systems and distributed I/O hardware.



## Multi I/O

### BOX - RELAY I/O CARD & MODBUS/JBUS INTERFACE

The Multi I/O is a device that integrates UPS into a control system using fully configurable input and output relay signals. It can be used to connect two devices to a single UPS serial communication port.

It can be used anywhere where several serial connections are required for multiple polling of the UPS.

It can also communicate on RS485 lines using the MODBUS/JBUS protocol.

#### FEATURES

- 8 analogue/digital inputs;
- 8 relay outputs (3 A at 250 V) that can be configured using UPS and input operating states;
- Can communicate with UPS via RS232;
- It can control two independent RS232/RS485 serial lines to monitor the UPS and its operating states using the MODBUS/ JBUS protocol;
- Firmware upgradeable via serial port.



## Multi Panel

### REMOTE DISPLAY INTERFACE

The Multi Panel is a remote monitoring device that can provide a detailed UPS status overview in real time. This device is able to display mains power, output and battery readings as well as UPS operating states. The high visibility graphic display supports English, Italian, German, French, Spanish, Russian, Chinese and many other languages. It has 3 independent serial ports, one of which allows for UPS monitoring via the MODBUS/JBUS protocol (on either an RS485 or RS232 serial line). The other independent serial lines can be used to connect devices such as the NetMan 208 or a PC running PowerShield<sup>3</sup> software.

### FEATURES

- High visibility LCD with graphic functions
- Management of three independent serial lines;
- Port configuration for MODBUS/JBUS as RS232 or RS485;
- Suitable for integration with the main BMS management programs;
- Firmware upgradeable via serial port.



# Connectivity

## Index of configurations

Connecting a UPS to other devices, sensors, computers and other specific devices, means on the one hand allowing the user to monitor UPS operating parameters and prevent critical situations and on the other hand provides the UPS with input parameters from the working environment. By processing these parameters the UPS is able to activate/

deactivate itself, communicate its status and much more.

This brief overview summarises some of the basic connectivity configurations, grouped according to the end purpose and situation surrounding each case.

- **Point to point connections;**
- **Multipoint connection;**
- **Connection for UPS in parallel setup;**
- **Connection with several systems in parallel setup and STS;**
- **Field bus connections;**
- **Bus connections over Ethernet;**
- **Field bus connections;**
- **Serial bus connections.**

## POINT TO POINT CONNECTIONS



Controlling the UPS from 1 workstation

- 1 UPS connected to load
  - 2 Local computer with PowerShield<sup>3</sup> version FREE
- USB or RS232

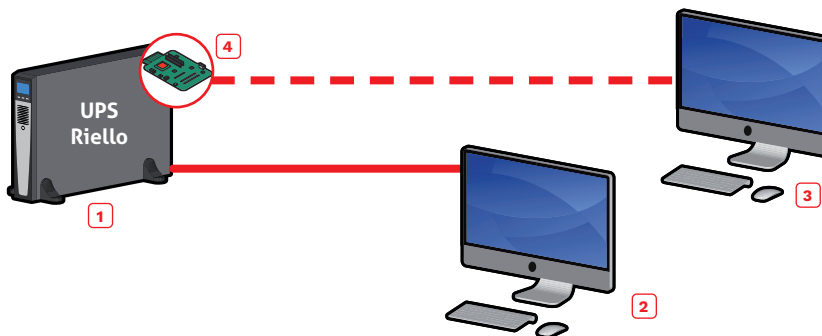

Controlling the UPS from different workstations

- 1 UPS connected to load
  - 2 Local computer with PowerShield<sup>3</sup> version FREE
  - 3 Local computer with PowerShield<sup>3</sup> software version FULL
  - 4 MultiCom 372 board
- RS232
- USB or RS232

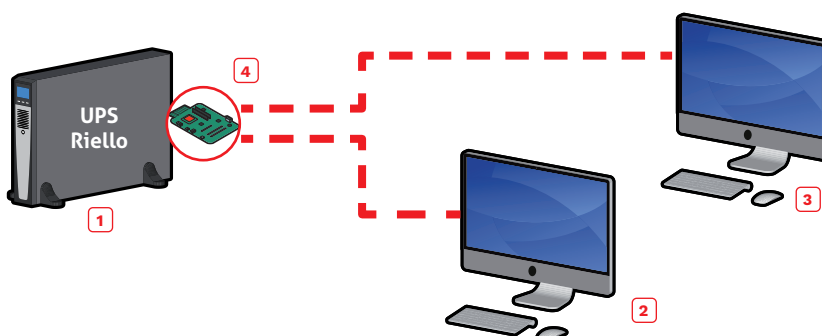

UPS control from several workstations, using 2 serial ports

- 1 UPS connected to load
  - 2 Local computer with PowerShield<sup>3</sup> version FREE
  - 3 Local computer with PowerShield<sup>3</sup> version FREE
  - 4 MultiCom 352 board
- RS232

## DISTRIBUTED CONNECTION (MULTIPOINT)

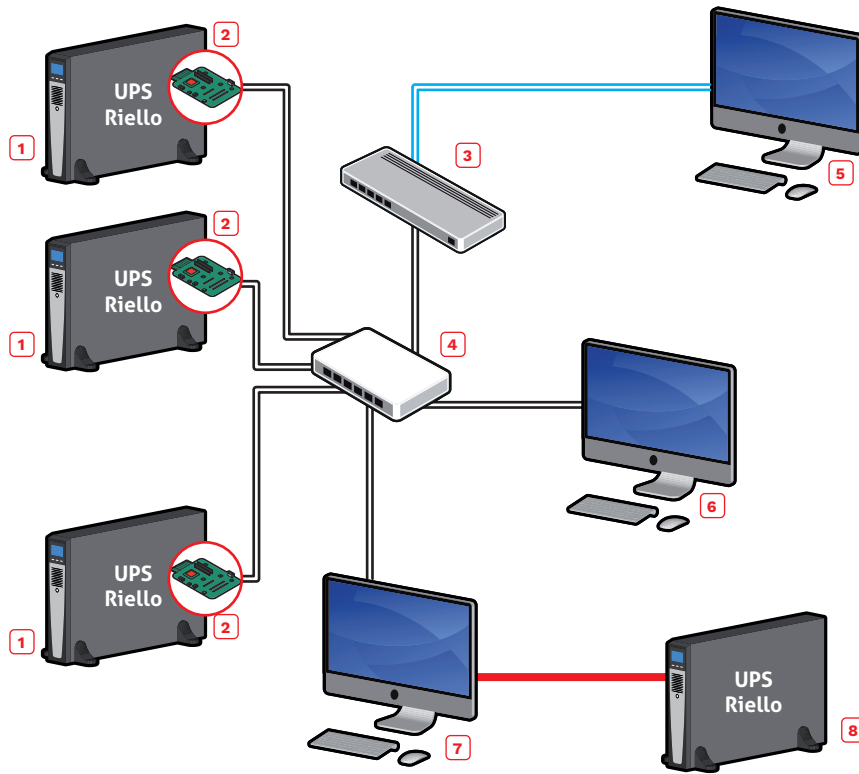

Connection with more than 1 UPS.  
The FULL version of PowerShield<sup>3</sup> software is required as well as a NetMan 208 communication board on each UPS.

- 1 UPS connected to load
- 2 NetMan 208 board
- 3 Firewall
- 4 Switch
- 5 Remote computer connected via web
- 6 Local computer
- 7 Local computer that controls the UPS (8) via USB or RS232 and UPS (1) via LAN and Ethernet
- 8 UPS connected to load

— USB or RS232  
— Ethernet  
— World Wide Web

## CONNECTION FOR UPS IN PARALLEL SETUP

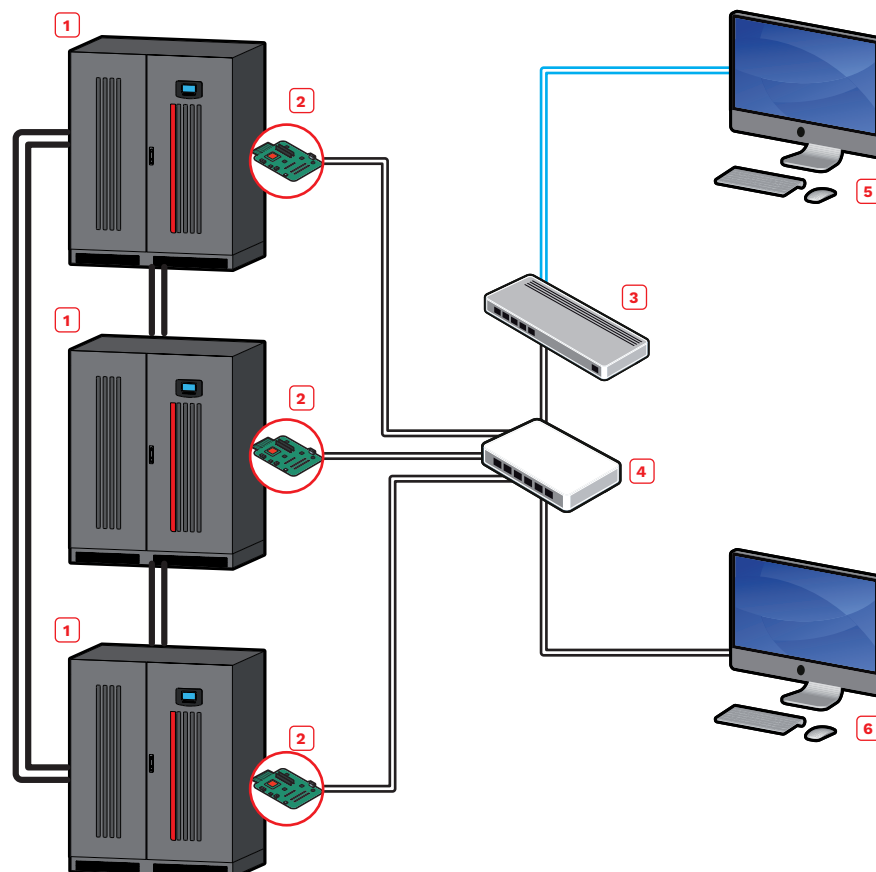

The FULL version of PowerShield<sup>3</sup> software should be used for managing setups with several UPS installed in parallel and each UPS must have a NetMan 208 board installed.

- 1 UPS in parallel setup connected to the load
- 2 NetMan 208 board
- 3 Firewall
- 4 Switch
- 5 Remote computer connected via web
- 6 Local computer

— Ethernet  
— World Wide Web  
— Parallel setup bus

## CONNECTION WITH SEVERAL SYSTEMS IN PARALLEL AND STS

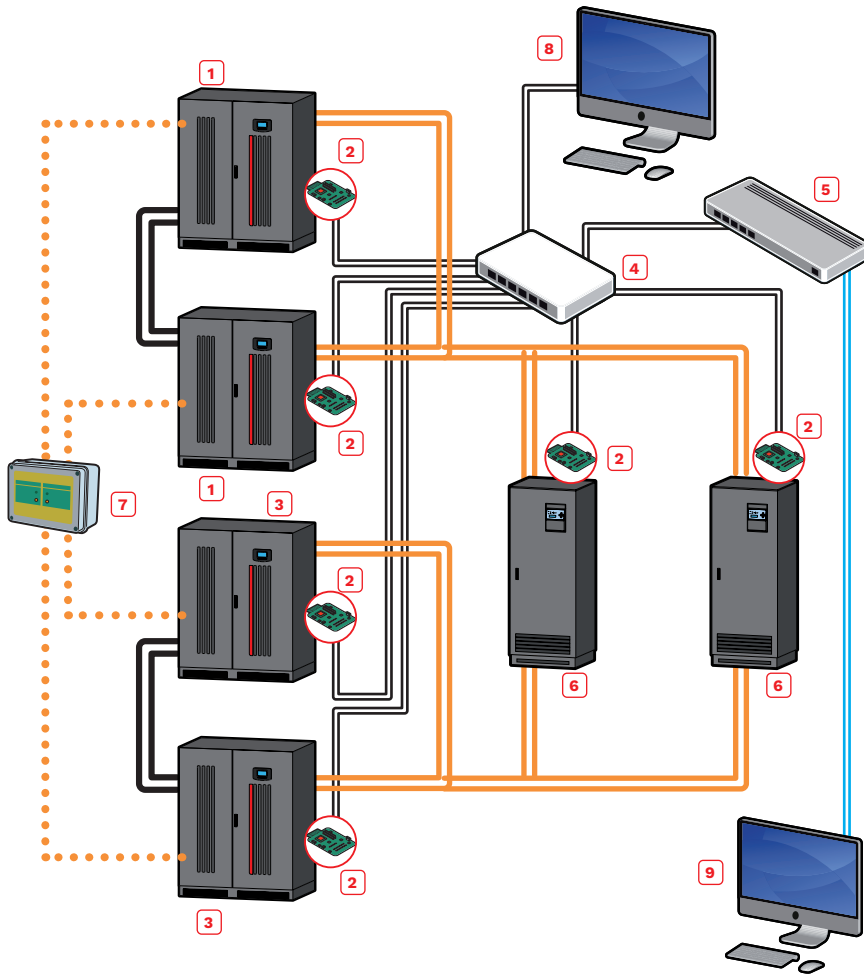

The FULL version of PowerShield<sup>3</sup> software should be used for managing setups with several UPS installed in parallel and each UPS must have a NetMan 208 board installed.

- 1 UPS arranged in parallel connected to an STS channel
- 2 NetMan 208 board
- 3 UPS arranged in parallel connected to an STS channel
- 4 Switch
- 5 Firewall
- 6 STS connected to load
- 7 UGS
- 8 Local computer with PowerShield<sup>3</sup> software version FULL
- 9 Remote computer connected via web, running PowerShield<sup>3</sup> software version FULL

..... UGS management of parallel setup

— Ethernet

— World Wide Web

— Parallel setup bus

— Power connection

## FIELD BUS CONNECTION OVER ETHERNET

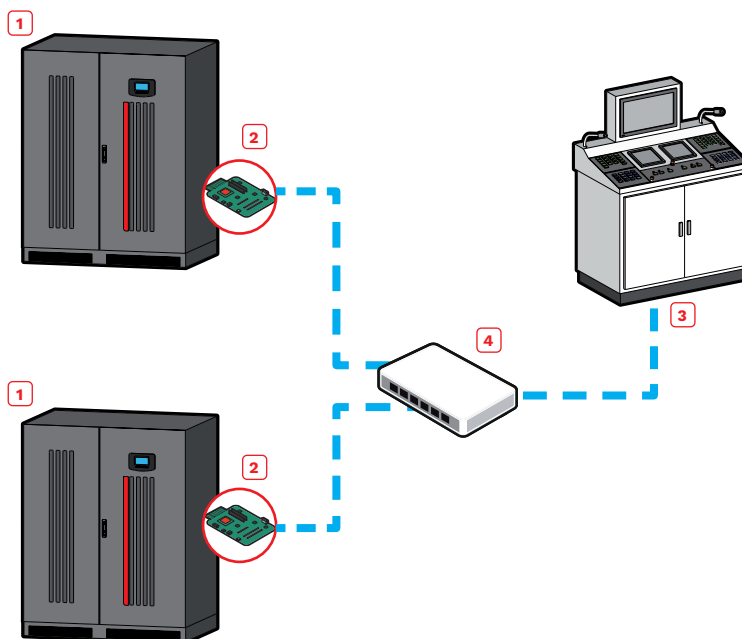

For UPS management in industrial or civil environments requiring Modbus protocol communication over Ethernet.

- 1 UPS connected to load
- 2 NetMan 208 board
- 3 SCADA management system
- 4 Switch

— Modbus / TCP over Ethernet

## POWERSHIELD<sup>3</sup> ON VIRTUALISED SYSTEMS: MICROSOFT HYPER-V; CITRIX

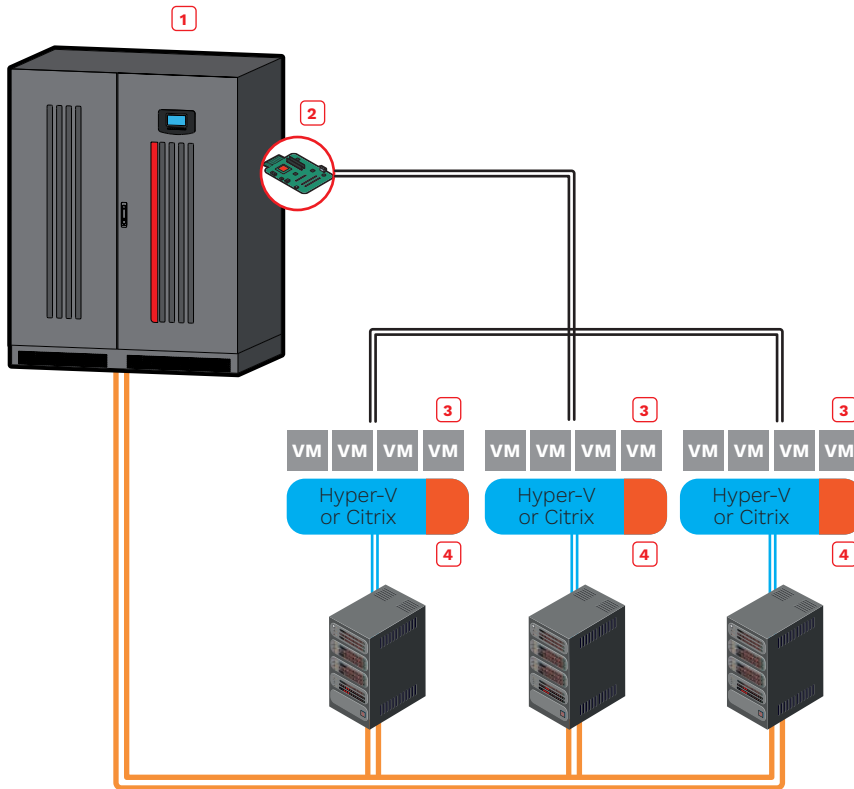

Powershield<sup>3</sup> software should be used for managing setup with UPS, a specific script to shut down the virtualised system must be used, UPS must have a NetMan 208 board installed.

- 1 UPS
  - 2 NetMan 208
  - 3 Virtualised system
  - 4 Powershield<sup>3</sup>
- Ethernet  
 — Power connection

## NETMAN 208 ON VIRTUALISED SYSTEMS: WMMWARE ESXI

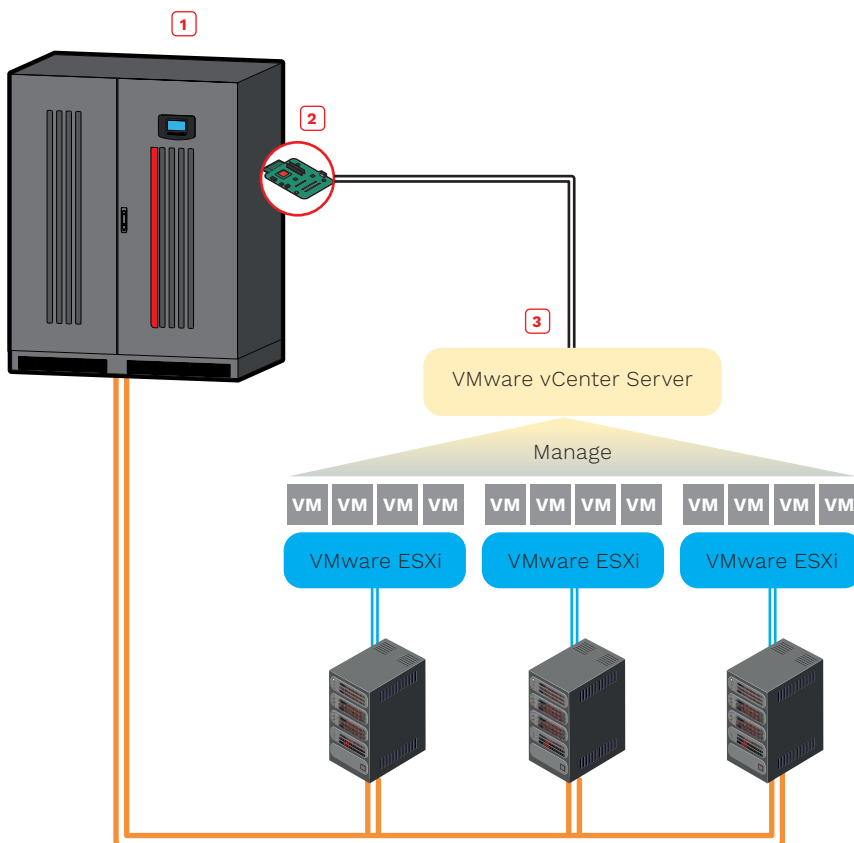

NetMan 208 should be used for managing Esxi hosts and vCenter servers, enabling you to manage your virtual network to perform shutdown or live migrations of active virtual machines as well as shutdown of physical hosts with delay and priority.

- 1 UPS
  - 2 NetMan 208
  - 3 Virtualised system
- Ethernet  
 — Power connection







**Services  
and contacts**





## Technical Energy Consultant

### The TEC Team

Our TEC (Technical Energy Consultant) experts have been working in the power sector for years. They come from a range of backgrounds and enjoy a wealth of technical experience in sectors such as Data Centers, Industry and Power Plants. By adopting a consultative, honest approach, our engineers and technicians support customers to achieve the perfect outcomes in power quality and power protection for their business.

The TEC Team keeps up-to-date regarding the latest trends in energy management and energy infrastructures. This means they have a deep understanding of the latest energy efficiency technologies including Smart Grids, Cloud and IoT energy requirements, Energy Storage aimed for Demand Response (Frequency Response or Peak Shaving), Supercapacitors and Lithium solutions.

### Consultancy on standards

Our TEC Team provides professional support to help customers comply with all necessary regulations (UNI, ISO or UL CSA standards) and related requirements, including the issues of energy management and safety protection. Furthermore, the TEC Team's energy management expertise is aided by ongoing discussions with Riello UPS's Research and Development department, which is always aware of the latest regulatory standards.

Whatever your need, our TEC Team will help you to find the most effective solution.

The TEC Team can provide exhaustive information concerning:

- Special appliances with particular IP ratings (e.g. IP30, IP31, IP41, IP42);
- Special treatments that enable UPS to perform in tropical conditions or to withstand the effects of earthquakes;
- Tailored systems providing optimal CapEx and OpEx;

# Pre-sales consultancy

- Customised solutions with a “pay as you grow” approach.

In addition, the TEC Team provides regulatory standard consultancy concerning:

- Products and portfolio solutions;
- Batteries, supercapacitors, lithium solutions;
- Installation and configuration;
- Applications (data centers, emergency lighting, electro-medical, railways etc.).





#### **Work tools - Training and information**

The TEC Team can provide extensive documentation and work tools including:

- UPS sizing;
- Official technical guides;
- Installation requirements;
- TEC newsletters and training webinars;
- Technical specifications;
- Technical presentation;
- On line tools (TEC area, UPS configurator, Riello Toll Box (runtime calculation), etc.

#### **Technical seminars**

The TEC Team stages regular technical seminars and training sessions. Customers, engineering firms and sector associations can also request for specific seminars to be staged on-site or at suitable locations.

#### **Design support**

The TEC Team can provide technical assistance concerning the recommended choice, sizing and installation of our complete range products and solutions.

#### **Help Desk**

TEC Team support is available by phone or email. We guarantee a response to any query as soon as possible.

#### **FAT- Factory Acceptance Tests (Witness Test)**

The Factory Acceptance Test (FAT) is a process that evaluates the equipment after the assembly process by verifying that it is built and operating in accordance with design specifications. It consists of a variety of inspection points and tests per the request of the customer, based on their requirements or unique equipment specifications.

In general, an FAT covers:

- **Comprehensive inspection** – based on the equipment and the requests of the customer. This can also include a range of conformity checks and verifications;
- **Contract audit** – a review of the original agreement to make sure all contractual obligations are met;

- **Operational test** – this procedure simulates the system in operation to provide proof of functionality. During these tests the system is analyzed both in static and dynamic conditions, so to validate the declared performances and the customer's expectations.

These tests also include verification of all relevant supporting documents, including user manuals, P&IDs and any type of instructions that come with the equipment to make sure they are accurate.

All inspection and testing is done at the state-of-the-art Riello UPS facilities in Legnago and Cormano. Riello UPS technicians and members of the TEC Team accompany customers and oversee all the tests.



## Service

# Technical assistance

### **The Service Team: guaranteeing the performance and quality of our products over time**

The proven quality and reliability of Riello UPS products is complemented by unmatched after-sale service.

By adopting a highly professional approach, our engineers and technicians provide reliable and qualified technical support that enables our customers to promptly solve any problem that may occur to their power protection systems.

In addition, the Service Team's ability to analyze data from the UPS encourages preventive, predictive or corrective maintenance. In this way, any necessary interventions can be scheduled cyclically, minimising the likelihood of a fault and enabling prompt intervention in the event of sudden problems or unexpected anomalies.

From electrical installation and commissioning to ongoing maintenance



**Service  
1st start**

and product training, our Service Team is constantly committed to achieving the target of zero downtime of the installed Riello UPS power continuity solutions and lead the customers into the future of the real-time energy management.

### **The services**

Our Service Team provides customers with:

- A call center to have direct and immediate contact with the Service department. These technical staff are available to provide expert advice on the installation and maintenance of the equipment;
- The swap service for small UPS;
- The on-site technical assistance service for larger non-transportable UPSs, whether they are under warranty or post warranty. Rapid interventions are made possible by the design concept of our products, by the professionalism of the Service Team personnel and by the well-established distribution networks in each territory;

- The on-site service for replacing exhausted batteries and the procedures for transferring them for safe and proper disposal;
- Preliminary site inspections to ensure the installation rooms are suitable, followed by commissioning of the UPS, including the initial start up, to ensure it is fully functional;
- Bespoke preventive maintenance contracts tailored to the customer's specific requirements;
- RielloConnect remote monitoring which analyzes the operating status. The technical team is always on-call to provide an immediate response to any alarm notifications.

These are the main services that Riello UPS provides to ensure **maximum protection of the power systems** and **after-sales peace of mind**.



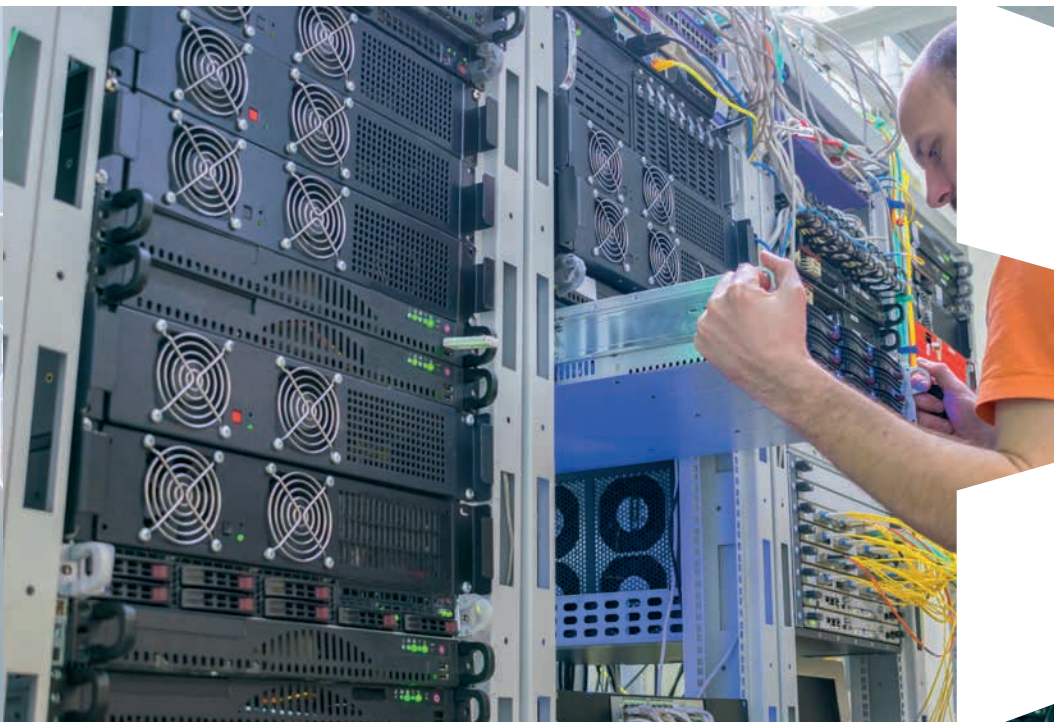

1

**EXPERIENCE**

extensive knowledge of the product and its use in every application, made possible by an ongoing process of training our technicians and keeping them constantly up-to-date with the latest trends.

2

**EXPERTISE**

constant communication between the Service and Research and Development teams enables a continuous exchange of information and technical knowhow.

3

**PRESENCE**

Riello UPS ensures a widespread coverage of its Service structure throughout each national territory. It deploys a network of professional and expert Help-Desk operators to provide immediate responses to customers. This is complemented by a group of highly-trained and competent technicians and service engineers that can quickly be deployed for on-site interventions.

4

**SPEED**

faults and failures can be quickly repaired thanks to a broad network of service engineers in each territory, plus the immediate availability of spare parts stored across various strategically-placed locations.

5

**CONTROL**

performance and efficiency can be precisely optimised thanks to ongoing on-site maintenance or through the RielloConnect remote monitoring platform.

6

**COVERAGE**

Riello UPS enjoys a growing presence throughout the world thanks to its local branches and distributors who work together in mutual cooperation to meet the customers' needs.

Direct technical phone consultations;

Commissioning interventions;

Site acceptance test;

Maintenance interventions;

Technical audits;

Emergency service call.



Riello**Connect**

## **RielloConnect** a step in the future for proactive monitoring

**RielloConnect** Riello UPS is a new concept of remote monitoring service based on the Internet of Things and new trends linked to Industry 4.0, which are designed to increase the resilience and reduce downtime of your mission critical equipment. The possibility of creating smart UPS and extending their functionality thanks to the cloud has enabled the development of new approaches of monitoring systems.

The innovative service is included in NetMan 204 with firmware 4.xx and the new NetMan 208, RielloConnect is an IoT connectivity feature that makes Riello UPS even more adaptable and easier to deploy: RielloConnect allows you to view the status of your UPS through a dedicated APP and through new secure web portal. Through this innovative remote monitoring service, you will receive automatic notifications, firmware updates notifications and advanced support (see price).

### **Predictive Analytics**

RielloConnect predictive analytics encourages future-planning based on historical data and analytics techniques, such as statistical modelling and machine learning. The predictive analytics can generate future insights with a significant degree of precision. With the help of sophisticated tools and models, Riello UPS can now use past and current data for UPS and battery condition to reliably forecast trends and behaviours days, weeks, or even years into the future.





**Advance monitoring system**

As a standard feature, RielloConnect offers the remote monitoring of the status of your Riello UPS and its battery systems. The dedicated APP shows the UPS status, real-time measurements and any alarm notifications.

The advanced level also records all vital data and generates a monthly report with analytics.

**Service enabled**

RielloConnect offers the invaluable peace of mind that comes from knowing the performance of your Riello UPS and its battery systems are being continually monitored by trained Riello UPS technical specialists.

Utilising the RielloConnect system, our UPS technicians can identify problems before they become load loss events. In the event of a UPS alarm, the RielloConnect system can notify your chosen first response contact (via APP or e-mail) 24/7/365. Meanwhile, an authorised Riello Service Technician remotely investigates and takes action appropriate to your individual Service Contract.

- Riello technical specialists continually monitoring your Riello UPS uninterruptible power supply.
- Receive alarm notification by APP or email.

- Receive regular predictive analysis and performance reports for your UPS from the RielloConnect Data Center, where the historical performance data is stored and analysed by sophisticated algorithms.

## HOW IT WORKS:

1. Install your UPS and Netman 208



2. Register your UPS



3. Activate RielloConnect

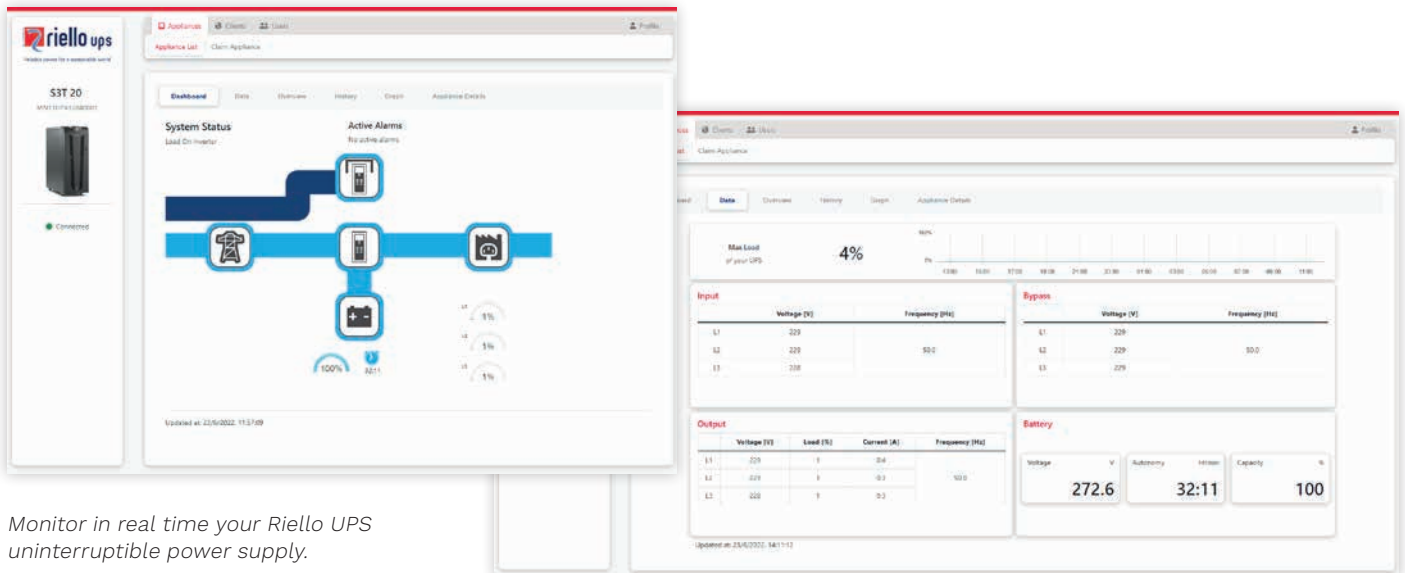

Monitor in real time your Riello UPS uninterruptible power supply.

### Basic plan

With the basic subscription you will have access to your UPS via the web portal and our dedicated APP.

You will be able to monitor the operation of the UPS in real-time and view graphs of key measurements (voltage, current, frequency, autonomy and temperature). You'll also receive alerts in via email or the APP in the event of any alarms.

### Professional plan

In addition to the benefits of the basic plan, you'll also get the recording of data logs for one year and receive monthly reports with UPS operating statistics.

### Service plan

To be allowed with Service Team.





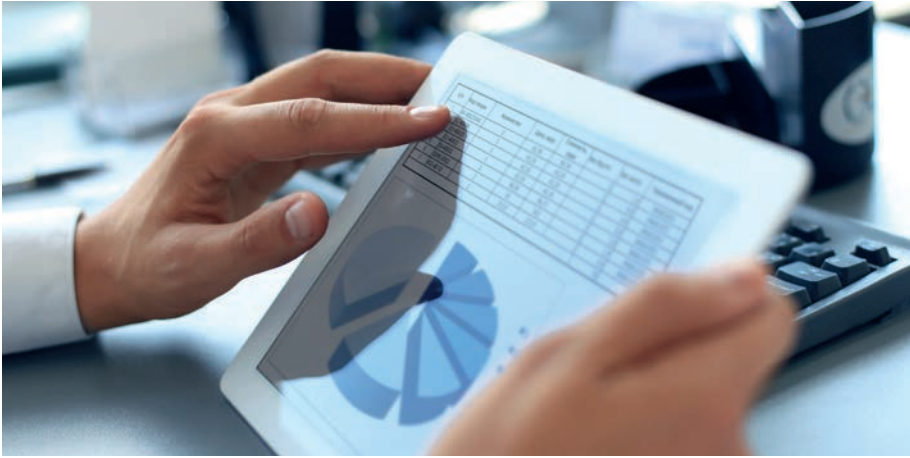

## MONTHLY PERFORMANCE REPORTS

By collecting and storing the performance data of the UPS, RielloConnect can compare current and historical data in order to produce a number of different reports which analyse the overall health of your UPS system. This regular reporting feature is an integral part of the RielloConnect service, assisting with your power management decisions.

## AVAILABLE PRODUCTS

The RielloConnect is connected to the UPS through the NetMan 204 or NetMan 208 or using the RielloConnect RCT 60x gateway in case of limitation or absence of the customer network infrastructure. The Netman 20x and RielloConnect RCT 60x creates a secure and encrypted remote connection from the UPS to the RielloConnect Data Center, where performance data is stored and analysed. Should the UPS trigger an alarm, Riello UPS technicians at our RielloConnect Data Center can access the current UPS data and commence any trouble shooting through an SSL encrypted connection, ensuring a rapid response to any potential issues.

### NetMan 208



- Security boot;
- Complete firmware upgrade via web browser;
- Accessible from any internet connected device;
- Dedicated APP for iOS and Android devices;
- Actionable alerts and lifecycle recommendations;
- Enhanced troubleshooting and support;
- Simple account login and registration.

### NetMan 204 RielloConnect Ready\*

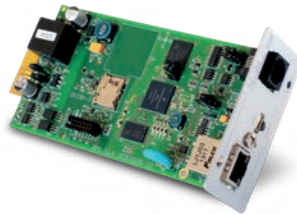

- Accessible from any internet connected device;
- Dedicated APP for iOS and Android devices;
- Actionable alerts and lifecycle recommendations;
- Enhanced troubleshooting and support;
- Simple account login and registration.

\* Firmware 4.01 or higher with B22-3 operating System version.

### RCT 605



The RielloConnect remote gateway is the solution for wireless connections. The RCT 605 is equipped with a GSM/GPRS modem allowing remote monitoring of the UPS from the RielloConnect Data Center without any connection to the customers LAN.

## RPS S.p.A.

### ITALY

#### LEGNAGO (VR)

##### Head Office

Viale Europa, 7  
37045 LEGNAGO (Verona)  
Tel +39 0442 635811

#### CORMANO (MI)

##### Sales Office

Via Somalia, 20  
20032 CORMANO (Milano)  
Tel +39 02 663271

Visit [www.riello-ups.com/bases](http://www.riello-ups.com/bases)  
for contact details.

## WORLDWIDE SUBSIDIARY COMPANIES

### USA

#### RPS America, Inc.

8808/8840 Beckett Rd  
West Chester, OH 45069

### UNITED KINGDOM

#### RIELLO UPS Ltd.

Unit 50 Clywedog Road North  
Wrexham Industrial Estate  
Wrexham LL13 9XN

#### CONSTANT POWER SERVICES Ltd.

Riello House, Works Road,  
Letchworth  
SG6 1AZ Hertfordshire

### IRELAND

#### RIELLO UPS IRELAND Ltd.

Suite 4.01, Ormond Building,  
31-36 Ormond Quay Upper  
Dublin 7  
D07 F6DC

### GERMANY

#### RIELLO UPS GmbH

Wilhelm-Bergner-Str. 9b  
21509 Glinde

#### RIELLO POWER SYSTEMS GmbH

Neufahrner Str. 12b  
85375 Neufahrn/Grüneck

### FRANCE

#### RIELLO ONDULEURS S.a.r.l.

4 Rue du Bois Chaland,  
ZAC du Bois Chaland  
91090 Lisses

### SPAIN

#### RIELLO ENERDATA s.l.

C/ Labradores, 11  
Parque Empresarial  
Prado del Espino  
28660 Boadilla del Monte  
Madrid

#### RIELLO TDL s.l.

C/Berguedà, 6 bis  
Pol. Ind. Plà de la Bruguera  
08211 Castellar del Vallès, Barcelona

### ROMANIA

#### RIELLO UPS ROMANIA S.r.l.

Str. Varsovia Nr. 4  
307160 Dumbravita  
Timis County - Romania

### POLAND

#### RIELLO DELTA POWER Sp. z o.o.

ul. Krasnowolska 82 R  
02-849 Warszawa

### AUSTRALIA

#### RIELLO UPS AUSTRALIA Pty. Ltd.

Unit 4, 60-68 Box Road  
Taren Point - Sydney

### ASIA PACIFIC

#### RIELLO UPS SINGAPORE Pte Ltd.

No. 506 Chai Chee Lane,  
#07-01, Singapore 469026

### CHINA

#### RIELLO UPS (Asia) Co., Ltd.

Room 102, building 12,  
no. 535 Shennan Road,  
Minhang district,  
201108, Shanghai P.R. of China

### INDIA

#### RIELLO POWER INDIA Pvt. Ltd.

Plot no. 213A, Sector-4,  
IMT Manesar, 122050 Gurgaon (HR)

### ARABIAN PENINSULA

#### RIELLO UPS Middle East FZ-LLC

Dubai Science Park  
North Tower, 8<sup>th</sup> Floor, Office 801N  
Al Barsha South, 500767





**RPS S.p.A. - Member of the Riello Elettronica Group**  
Viale Europa, 7 - 37045 LEGNAGO (Verona) - Italy  
T +39 0442 635811 - [www.riello-ups.com](http://www.riello-ups.com)



Product photos are purely indicative. Due to technical improvements and/or changes in regulatory standards, product specifications are subject to change without notice.

CATGENX0Y24AREN